

CSB1-20G



UPC Code: 07847724071

Country of Origin: United States - **Eligible for ARRA funded projects*



**May include one or more globally sourced components.*



Brand Features

Leviton's Commercial Specification Grade switches are designed to offer outstanding reliability and top performance in commercial settings. Ideal applications include municipal facilities, government buildings, malls, department stores, hospital and health care facilities, office buildings, schools, colleges, universities, houses of worship and cultural institutions. Leviton offers a large selection of 15 and 20 Amp Commercial switches, available in a wide variety of colors, wiring options and other features.

Item Description

20 Amp, 120/277 Volt, Toggle Single-Pole AC Quiet Switch, Commercial Spec Grade, Grounding, Back & Side Wired, - Gray

Technical Information

AC Horsepower Ratings

HP Rating: 1HP-120V 2HP-240V

Electrical Specifications

Amperage: 20 Amp

Voltage: 120/277 VAC

Max. Amperage: 16 Amp

Dielectric Voltage: Withstands 1500V for 1 minute

Temperature Rise: Maximum 30 degrees C rise

Environmental Specifications

Flammability: Rated V-2 per UL94

Operating Temperature: -40°C to 65°C

Material Specifications

Body Material: Thermoplastic

Base Material: PBT

Strap Material: Steel

Actuator Material: Polycarbonate

Toggle: Polycarbonate

Cover Material: Nylon

Contacts: Silver-Cadmium .031 Thick

Terminal Screws: Steel 8-32

Color: Gray

Mechanical Specifications

Terminal ID: Brass-Hot, Green-Ground, Silver-Neutral

Terminal Accom.: 14-#10 AWG back wired; #14-#12 AWG side wired

Termination: Back & Side

Product ID: Stamped on Strap

Torque Range: 12-14 inch pounds

Product Features

Voltage: 120/277 Volt

HP Rating: 1HP-120V 2HP-240V-277V

Actuator Material: Thermoplastic

Color: Gray

Warranty: 10 Year Limited

Standards and Certifications

NEMA: WD-1 & WD-6

ANSI: C-73

UL Fed Spec WS896E: File #E7458

UL Standard: UL 20

CSA C22.2 No. 111: File #152105

NOM: 057

Warranty: 10-Year Limited

Dimensional Diagram

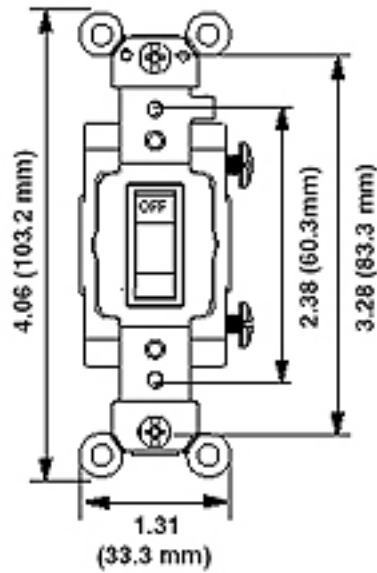

Wiring Diagram Single Pole

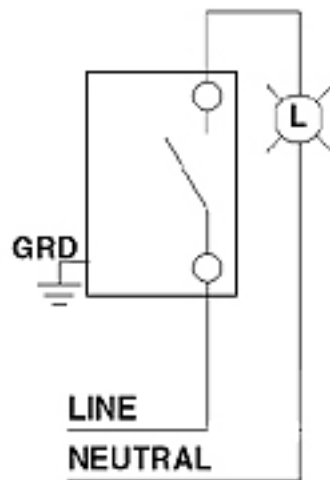

SPECIFICATION SUBMITTAL

JOB NAME: <input type="text"/>	CATALOG NUMBERS: <input type="text"/>	
JOB NUMBER: <input type="text"/>	<input type="text"/>	<input type="text"/>

Leviton Manufacturing Co., Inc.

201 North Service Road, Melville, NY 11747

Telephone: 1-800-323-8920 · FAX: 1-800-832-9538 · Tech Line (8:30AM-7:30PM E.S.T. Monday-Friday): 1-800-824-3005

Leviton Manufacturing of Canada, Ltd.

165 Hymus Boulevard, Pointe Claire, Quebec H9R 1E9 · Telephone: 1-800-469-7890 ·

FAX: 1-800-824-3005 · www.leviton.com/canada

Leviton S. de R.L. de C.V.

Lago Tana 43, Mexico DF, Mexico CP 11290 · Tel.: (+52)55-5082-1040 · FAX: (+52)5386-1797 · www.leviton.com.mx

Visit our Website at: www.leviton.com

© 2012-2016 Leviton Manufacturing Co., Inc. All rights reserved. Subject to change without notice.



Leviton has a global presence.

If you would like to know where your local Leviton office is located please go to: www.leviton.com/international/contacts/

**Buy American Compliant Logo -- The American Recovery And Reinvestment Act of 2009 ("ARRA") provides federal grants and loans for projects throughout the country. Section 1605 of the Act, named the "Buy American" provision, requires that certain materials and manufactured products used in projects funded by the Act be manufactured in the United States. The appearance of the Recovery Act Logo in relation to a Leviton product is only intended to reflect that such product may be used in an ARRA funded project. It does not mean that such product or Leviton is sponsored or endorsed by, or that Leviton receives funds from, the federal government or the Recovery Accountability and Transparency Board. Nothing in Leviton's use of the logo is intended to suggest anything regarding the requirements for funding under ARRA.*