

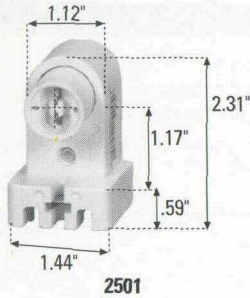

Fluorescent Lampholders

Recessed Double Contact Slimline



2501

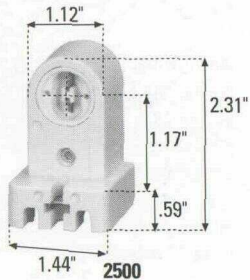

2500

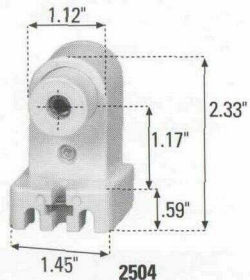

2504

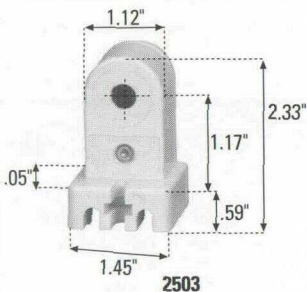

2503

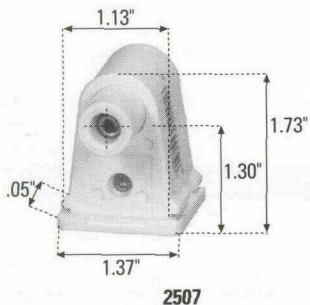

2507

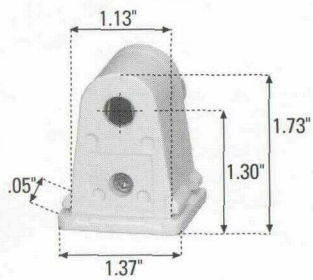

2506

Fluorescent Lampholders

Features:

- Meets all UL 1572 requirements.
- Molded of white thermoset plastic for neat appearance and durability.
- For replacement use in fluorescent lighting fixtures as well as enclosed outdoor signs.
- Recessed double-contact (2500, 2501) lampholders can be used for flush or surface mounting.

- Plunger lampholders feature non-sticking, spring-loaded plunger to hold lamp securely.
- Captive pal nut for easy mounting.
- Push-in wire terminals feature release slots.
- Made in USA.

Recessed Double Contact

Catalog No.

Rating W V	Description	Terminals	Mounting	Color	
660 600	Plunger	Push Wire	Screw	White	2501W
660 600	Stationary	Push Wire	Screw	White	2500W

Slimline

Catalog No.

Rating W V	Description	Terminals	Mounting	Color	
660 1000	Plunger	Push Wire	Screw	White	2504W
660 600	Stationary	Push Wire	Screw	White	2503W
660 1000	Plunger	Push Wire	Slide-On	White	2507W
660 600	Stationary	Push Wire	Slide-On	White	2506W

Panel Cutouts

2500, 2501, 2503, 2404

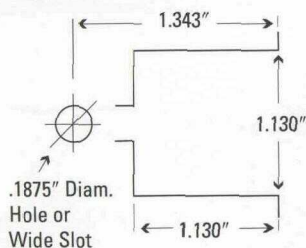

2506, 2507

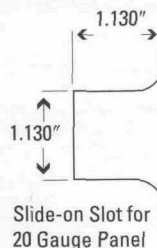

K5

Lampholders