

BURNDY

Compression



ONE HOLE HYLUG™ CODE CONDUCTOR STANDARD BARREL (CONTINUED)

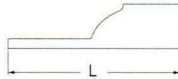

Fig. 1

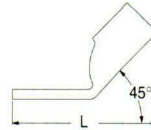

Fig. 2

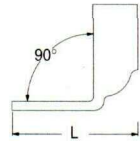

Fig. 3

Catalog Number	Fig #	Conductor		Stud Hole Size	Tongue Width	Length (L)	Tongue Angle	Installation Tooling					WIRE STRIP LENGTH								
		AWG	MM²					Mechanical	Hydraulic		COLOR CODE	DIE INDEX									
								MD7-34R	BCT500 Y500CT	Y750-2/Y46C BAT-750C											
YA6CL4-BOX	1	#6 AWG		3/8"	63"	1.83"	Straight	W5CVT (1) W5CRT (1) X5CRT (1) X8CART (1)	W5CVT (1) W5CRT (1) X5CRT (1) X8CART (1)	U5CRT (1) UBCABT (1)	BLUE	7	7/8"								
YA6CL4-45	2				63"	1.57"	45 Degree														
YA6CL4-90	3				58"	1.05"	90 Degree														
YA6CL6-BOX	1			1/2"	75"	2.15"	Straight														
YA6CL6-45	2				75"	1.92"	45 Degree														
YA6CL6-90	3				81"	1.30"	90 Degree														
YA5CL-BOX	1	#5 AWG	16	1/4"	44"	1.65"	Straight	W5CRT (1) W5CVT (1) X5CRT (1)	W5CRT (1) X5CRT (1) W5CVT (1)	U5CRT (1)	BLUE	7	7/8"								
YA5CL-45	2				44"	1.51"	45 Degree														
YA5CL-90	3				44"	81"	90 Degree														
YA4CL-BOX	1	#4 AWG		1/4"	50"	1.74"	Straight	W4CVT (1) W4CRT (1) X4CRT (1)	W4CVT (1) W4CRT (1) X4CRT (1)	U4CRT (1) U6CABT (1)	GRAY	8	7/8"								
YA4CL-45	2					1.44"	45 Degree														
YA4CL-90	3					84"	90 Degree														
YA4CL1-BOX	1			8-10	50"	1.58"	Straight														
YA4CL1-45	2				50"	1.28"	45 Degree														
YA4CL1-90	3				49"	75"	90 Degree														
YA4CL3-BOX	1			5/16"	58"	1.92"	Straight														
YA4CL3-45	2					1.68"	45 Degree														
YA4CL3-90	3					96"	90 Degree														
YA4CL4-BOX	1			3/8"	58"	1.92"	Straight														
YA4CL4-45	2					1.68"	45 Degree														
YA4CL4-90	3					1.08"	90 Degree														
YA4CL6-BOX	1			1/2"	71"	2.20"	Straight														
YA4CL6-45	2					2.02"	45 Degree														
YA4CL6-90	3					1.32"	90 Degree														
YA3CL	1			# 3 STR # 2 SOL	25	5/16"	55"							1.88"	Straight	W3CRT (1)	W3CRT (1)	U3CRT (1)	WHITE	9	15/16"
YA3CL-45	2													1.76"	45 Degree						
YA3CL-90	3													98"	90 Degree						
YA2CL2-BOX	1	#2 AWG		1/4"	61"	1.88"	Straight	W2CVT (1) W2CRT (1) X2CRT (1)	W2CVT (1) W2CRT (1) X2CRT (1)	U2CRT (1)	BROWN	10	15/16"								
YA2CL2-45	2					1.55"	45 Degree														
YA2CL2-90	3					89"	90 Degree														
YA2CL-BOX	1			5/16"	61"	1.93"	Straight														
YA2CL-45	2				61"	1.62"	45 Degree														
YA2CL-90	3				60"	1.01"	90 Degree														
YA2CL4-BOX	1			3/8"	61"	2.06"	Straight														
YA2CL4-45	2					61"	1.74"							45 Degree							
YA2CL4-90	3					60"	1.14"							90 Degree							
YA2CL6-BOX	1			1/2"	73"	2.32"	Straight														
YA2CL6-45	2					2.17"	45 Degree														
YA2CL6-90	3					1.37"	90 Degree														
YA1CL2	1			#1 AWG		1/4"	68"							1.81"	Straight	W1CVT (1) W1CRT-1 (1) X1CRT-1 (1)	W1CVT (1) W1CRT-1 (1) X1CRT-1 (1)	U1CRT-1 (1) U4CABT (1)	GREEN	11	15/16"
YA1CL2-45	2													1.70"	45 Degree						
YA1CL2-90	3													91"	90 Degree						
YA1CL-BOX	1					5/16"	68"							1.94"	Straight						
YA1CL-45	2													1.82"	45 Degree						
YA1CL-90	3													1.03"	90 Degree						
YA1CL4-BOX	1	3/8"	68"			2.06"	Straight														
YA1CL4-45	2					1.95"	45 Degree														
YA1CL4-90	3					1.16"	90 Degree														
YA1CL6-BOX	1	1/2"	73"			2.37"	Straight														
YA1CL6-45	2					2.22"	45 Degree														

* Use P-UADP-1 adapter with "U" dies in Y46 HYPRESS™.
 ** P-RT die sets for use in Y46 HYPRESS™ only, P-UADP-1 adapter not required.
 ▲ See tooling section of this catalog for complete tool and die listings.
 ◆ For applications greater than 2000 Volts, consult cable manufacturer for voltage stress relief instructions.

BURNDY

Compression



INTRODUCTION

MEDIUM AND LARGE HYDENT™

Copper and aluminum compression terminals and splices for terminating conductors from #8 AWG through 2000 kcmil.

The medium and large HYDENT™ line is designed for terminating and splicing medium and large conductors in electrical power applications.

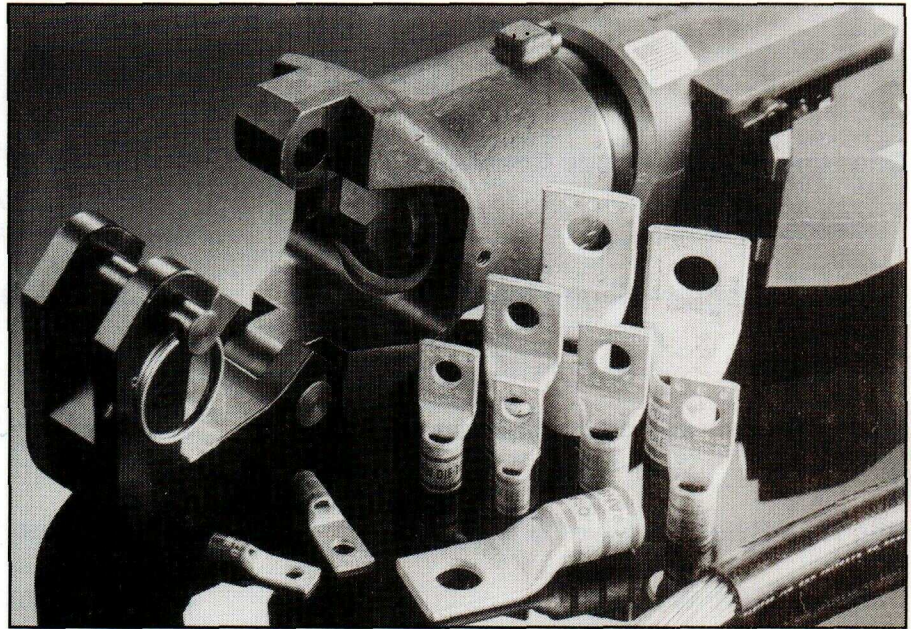

C-1

HYLUG™

UNINSULATED COPPER COMPRESSION TERMINALS

UL LISTED 90°C,
600 VOLT TO 35kV ♦

BURNDY's HYLUG™ terminals, types YA, YA-TC, YA-L, YA-L-TC, YA-2N, YA-2TC, YA-L-TC-FX, YA-L-2TC and YA-2LN are designed for terminating copper conductors in a wide variety of electrical connections, including heavy-duty industrial, utility, commercial and telecommunications applications.

The HYLUG™ terminals require simple cable preparation for an easily installed permanent and inspectable cable termination. The terminals are listed by UL (UL STD.486A) and CSA certified to 600 volt, when applied with the proper tool and die combination. The terminals may be used in applications to 35KV. See each catalog page for UL 35kV listings.

Features and Benefits

- Manufactured from seamless high conductivity electrolytic copper tubing with heavy duty wall thickness.
 - ◊ Provides maximum conductivity, low resistance and ductility for an excellent combination of electrical and crimp forming properties.
- Barrel diameter closely matches commercial (code) cable and navy cable diameters.
 - ◊ Provides an excellent relationship of the conductor/connector combination to produce a high quality electrical connection with the recommended tooling.
- Electro-tin plated. Electro-lead plated. Burndy's proprietary brite finish.
 - ◊ Provides durable long-lasting corrosion resistance.
- Internally beveled barrel end.
 - ◊ Provides easy cable insertion.
- Each connector is clearly marked with the wire size and type, die index, and color coding.
 - ◊ Provides easy identification and proper tooling recommendation.
- Marked with the proper number and location of crimps.
 - ◊ Lowers installed costs. Provides for proper installations.
- Proper compression systems forms a homogeneous mass.
 - ◊ The result is an excellent electrical connection.
- Use up to 35KV as indicated.
 - ◊ Suitable for high voltage applications.
- Expanded wire ranges when using Y644 HYPRESS™ Dieless "1" Crimp.
 - ◊ Provides ability to complete emergency repairs when connector and wire size do not match.
- Crimp areas clearly marked.
 - ◊ Provides correct number and location of crimps for proper installation.
- Hydraulic and Battery tooling crimp embossment.
 - ◊ Provides permanent die index number embossment on completed crimp for inspection purposes.

BURNDY

Compression

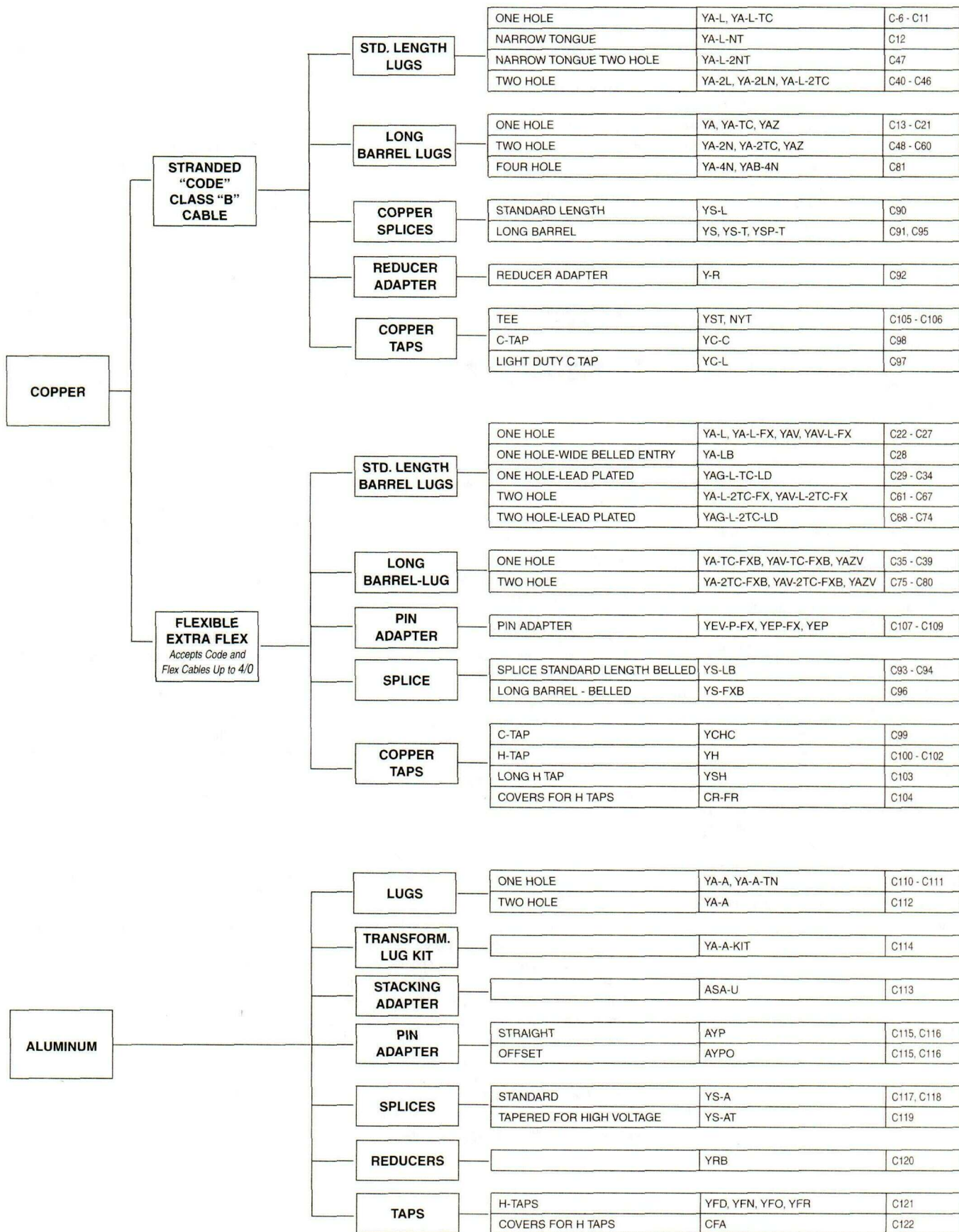



COMPRESSION CONNECTORS

Burndy's compression connectors are designed for reliable and controllable electrical connections. The complete installation is fully inspectable. They are high conductivity copper and operate cooler than the wire on which they are installed. The connectors withstand a wide range of electrical and environmental conditions, including current surges, temperatures, corrosion and vibrations, for a wide variety of applications. These features mean a consistently high quality connection at a low installed cost.

Copper compression connectors are manufactured from high-conductivity electrolytic copper. The connectors are normally tinned, lead-plated, or plated with proprietary Burndy brite finish to provide durable long-lasting corrosion resistance. The connector design has been matched to the cable size to provide the necessary physical strength requirements for reliable electrical performance.

Aluminum compression connectors are manufactured from high conductivity, high purity wrought aluminum. They are designed with sufficient mass and are electro-tin plated to minimize corrosion due to galvanic action between dissimilar metals. The connector barrels are pre-filled with PENETROX, Burndy's oxide inhibiting compound.

PENETROX contains homogeneously suspended metallic particles which penetrate the wire's oxides to establish excellent continuity between the individual strands and the connector barrel for a low-resistance connection. PENETROX maintains an air-tight connection. Each barrel end is covered with a color-coded plastic dust cap which prevents foreign matter from entering the connector before it is used. The connector design has been engineered to match the cable size to provide the necessary physical strength requirements for reliable electrical performance.

SELECTION AND USE

Copper compression connectors are recommended for use on copper conductors. Aluminum compression connectors are recommended for use on aluminum conductors. Dual-rated aluminum compression connectors may be used on both copper and aluminum conductors.

Two basic compression designs are available: Circumferential and indent.

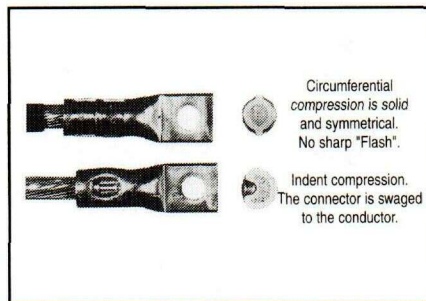

After compression, virtually all the air is removed leaving a tight homogeneous mass of connector and conductor.

The circumferential crimp design is recommended for color coded connectors in low and high voltage applications. Die index number embossment provides an easy inspection where required to verify the use of the proper connector/die combination. It is also recommended for insulated connectors and for terminating flexible and welding cables.

The circumferential crimp design dies compress cable strands into polygonal shapes forming intimate contact with each other and the connector barrel. This compression forms a tight homogeneous mass with virtually no air pockets. The circumferential crimp provides an excellent electrical connection with high pull-out values. The circumferential crimp is ideal for high voltage applications leaving the connector barrel symmetrical, which is easier to insulate.

The indent type crimp can be used in virtually any application except polyvinylchloride (PVC) insulated terminals and splices. It is an excellent means of terminating flexible, extra flexible and welding cables. The indenter compresses the cable strands to form intimate contact with each other and the connector barrel. The result is an excellent electrical connection with high pull-out strength. Laboratory work testing curves established the proper depth and shape of indent for each type of connector and wire combination.

TOOLING

Tooling systems are essential for proper installation of a compression connector. Since connectors and dies are designed as a unit for specific wire sizes, only the recommended tools and dies should be used. Most aluminum and copper HYLUG terminals and HYLINK splices are marked with a die index number and are color-coded to identify the correct installation die. Dies marked with the matching die index number and color can be used to install the connector.

Burndy tooling installs a wide range of connectors, is reliable, cost effective, and precision engineered for durable, long-lasting service and quality connections. The tools include small plier types, full cycle ratchet designs and hydraulically-powered HYPRESS heads and new Battery Actuated Tools. Some have permanent die grooves or adjustable dies, while others require a change of die sets or nest die for each connector size. Burndy's recommended tools achieve crimp performance consistent with UL and other industry standards. Since several tools are suitable for most connectors, the most economical and practical tool can be chosen for each application.

INDUSTRY STANDARDS

Burndy's compression terminals, splices and tap connectors requiring third party testing and approval are listed by Underwriters' Laboratories, Inc. Many have also received CSA approval and are approved under MIL-T-7928 and other military standards. All conform to applicable sections of the National Electrical Code.

Burndy also offers connectors and splices which meet the (LOCA Seismic and Aging) requirements of IEEE standards 323, 383 and 344 for class 1E critical circuits for use in Nuclear Utility Applications. Certification to 10CFR50 and 10CFR21 available.

Detail catalog listings should be consulted to obtain the appropriate standards for each connector and splice.

BURNDY

Compression



ONE HOLE HYLUG™ CODE CONDUCTOR STANDARD BARREL

TYPES YA-L, YA-L-TC

COPPER COMPRESSION TERMINAL

UL LISTED 90°C,
600 VOLT TO 35 KV ◆



C-6

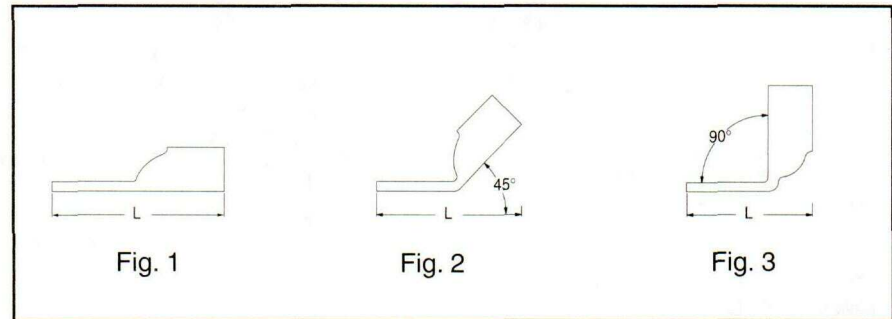
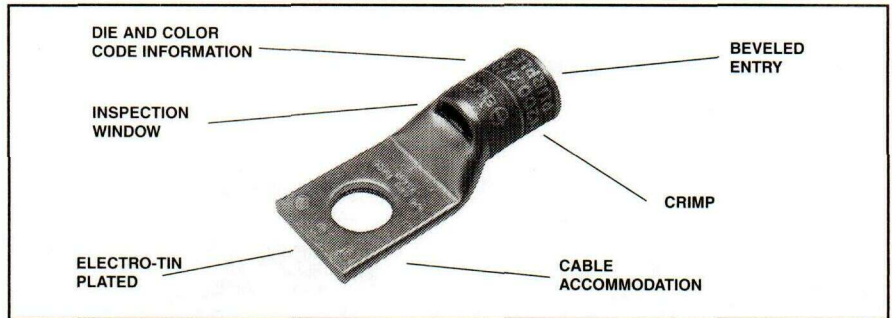

Catalog Number	Fig #	Conductor		Stud Hole Size	Tongue Width	Length (L)	Tongue Angle	Installation Tooling					WIRE STRIP LENGTH		
		AWG	MM²					Mechanical	Hydraulic		COLOR CODE	DIE INDEX			
								MD7-34R	BCT500 Y500CT	Y750-2/Y46C* BAT-750C					
YAV10-45 -BOX	1	#14 - #10 STR	10	8-10	38"	92"	45 Degree								
YAV10-BOX	1					1.02"	Straight								
YAV10R -BOX	1					77"	90 Degree								
YAV10R3 -BOX	1	#12-#10 SOL	10	1/4"	47"	83"	90 Degree						7/16"		
YAV10T2-BOX	1					5/16"	53"							1.12"	Straight
YAV10T3-45 -BOX	2					1/4"	47"							1.10"	45 Degree
YAV10T3-BOX	1	#8 AWG	10	1/4"	47"	1.10"	Straight								
YAV10T4-BOX	1					3/8"	56"							1.18"	Straight
YA8CL1-BOX	1					1.26"	Straight								
YA8CL1-45	2	#8 WELD 37/24	10	1/4"	44"	1.24"	45 Degree	W8CVT (1) W8CRT (1) X8CRT (1)	W8CVT (1) W8CRT (1) X8CRT (1)	U8CRT (1)	RED	49	7/16"		
YA8CL1-90	3					80"	90 Degree								
YA8CL2-BOX	1					1.38"	Straight								
YA8CL2-45	2	#6 SOLID	10	5/16"	52"	1.34"	45 Degree								
YA8CL2-90	3					92"	90 Degree								
YA8CL3-BOX	1					1.51"	Straight								
YA8CL3-45	2	1/2"	71"	3/8"	58"	1.45"	45 Degree								
YA8CL3-90	3					1.04"	90 Degree								
YA8CL4-BOX	1					1.76"	Straight								
YA8CL4-45	2	8-10	41"	1/2"	71"	1.67"	45 Degree								
YA8CL4-90	3					1.28"	90 Degree								
YA8CL-BOX	1					1.16"	Straight								
YA8CL-45	2	#6 AWG	10	1/4"	45"	1.16"	45 Degree	W5CVT (1) W5CRT (1) X5CRT (1) X8CART (1)	W5CVT (1) W5CRT (1) X5CRT (1) X8CART (1)	U5CRT (1) X5CRT (1) UBCABT (1)	BLUE	7	7/8"		
YA8CL-90	3					71"	90 Degree								
YA6CL-BOX	1					1.73"	Straight								
YA6CL-45	2	8-10	41"	1/4"	45"	1.43"	45 Degree								
YA6CL-90	3					81"	90 Degree								
YA6CL1-BOX	1					41"	1.54"							Straight	
YA6CL1-45	2	5/16"	52"	1/4"	45"	1.29"	45 Degree								
YA6CL1-90	3					42"	90 Degree								
YA6CL3-BOX	1					1.79"	Straight								
YA6CL3-45	2	3	93"	1/4"	45"	1.54"	45 Degree								
YA6CL3-90	3					93"	90 Degree								

* Use P-UADP-1 adapter with "U" dies in Y46 HYPRESS™.
 ** P-RT die sets for use in Y46 HYPRESS™ only, P-UADP-1 adapter not required.
 ▲ See tooling section of this catalog for complete tool and die listings.
 ◆ For applications greater than 2000 Volts, consult cable manufacturer for voltage stress relief instructions.