

Steel City®

Nonmetallic Sheathed Cable Fittings

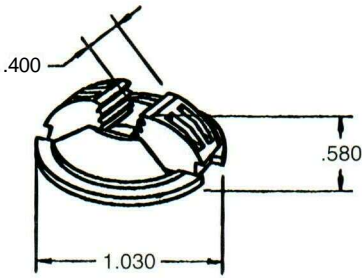

Hit Lock Connectors

Cat. No.	Description	Std. Ctn.
NC501-SC	W Hit Lock Connector	500
NC501DBL-SC	½" Double Hit Lock Connector	500
NC502-SC	f" Hit Lock Connector	100
SB1216-SC	Twist It Bushing For Metal Studs	50

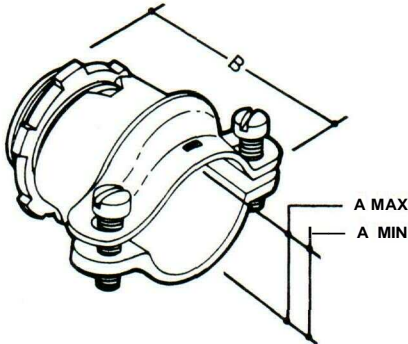
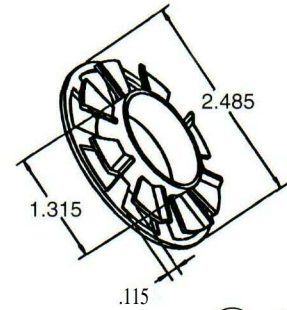
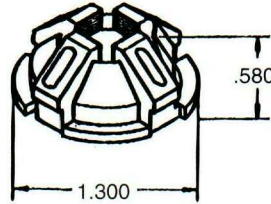
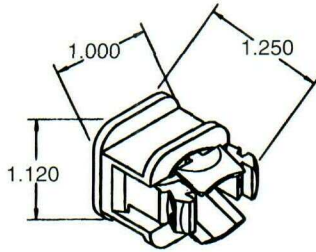

NM Clamp Type Connector - Die Cast Zinc



Cat. No.	Conduit Size	Dimensions (in.)			Std. Ctn.
		A (min.)	A (max.)	B	
NC-201	¾"	0.40"	0.95"	1.87"	250 ***
NC-202	¾"	0.50"	1.10"	1.84"	200
NC-203	1"	0.62"	1.14"	2.00"	100
NC-204	1¼"	0.50"	1.38"	2.28"	100
NC-205	1½"	0.75"	1.61"	2.49"	50
NC-206	2"	0.90"	2.04"	3.35"	50

CSA File No. LR-12798

U.L. File No. E-17583

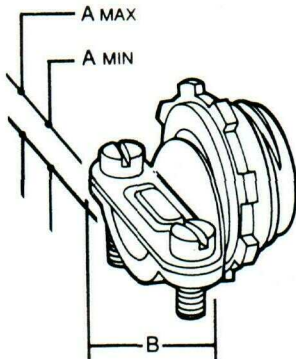

Clamp Type Connector - Die Cast Zinc



Cat. No.	Conduit Size	Dimensions (in.)			Std. Ctn.
		A (min.)	A (max.)	B	
NC-301	W (<2"KO)	0.18"	0.64"	1.16"	1000
NC-302	¾"	0.41"	0.82"	1.87"	500
NC-303	1"	0.34"	0.94"	2.01"	250

CSA File No. LR-12798

U.L. File No. E-17583

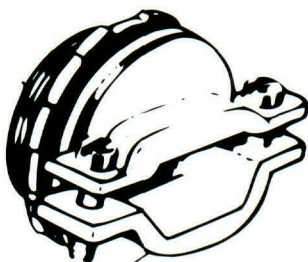

Connectors Clamp Type, Non-Watertight - Die Cast Zinc



Cat. No.	Conduit Size	Dimensions (in.)			Std. Ctn.
		A (min.)	A (max.)	B	
NC-041	1¼"	0.27"	0.75"	2.02"	100
NC-051	1½"	0.54"	0.95"	2.50"	50
NC-061	2"	0.75"	1.12"	3.41"	40

U.L. File No. E-15170-1¼"-1½"

U.L. File No. E-17583-2"

ThomasiBetts