

Dry Type Transformers

Section 10

For more information on these products, order publications listed in Section 28.

—**Find What You Need Faster** - Page headings and table format make product selection easier.

—**Easy Cross Reference** - Frame size listed with each model number. Use frame size to cross-reference dimensions, enclosure parts, and accessories.

General Information

Types QB, QMS, QL.....10-2

General Purpose

Single-Phase DOE 2016 Efficiency, Aluminum.....10-4

Single-Phase DOE 2016 Efficiency, Copper.....10-5

Three-Phase DOE 2016 Product Number Nomenclature.....10-6

Three-Phase DOE 2016 Efficiency, Aluminum.....10-9

Three-Phase DOE 2016 Efficiency, Copper.....10-11

K-Factor

Three-Phase DOE 2016 Efficiency, Aluminum.....10-12

Three-Phase DOE 2016 Efficiency, Copper.....10-16

K-Factor Low Noise

Three-Phase DOE 2016 Efficiency, Aluminum.....10-20

Three-Phase DOE 2016 Efficiency, Copper.....10-22

Low Noise

Three-Phase DOE 2016 Efficiency, Aluminum.....10-24

Three-Phase DOE 2016 Efficiency, Copper.....10-25

Noise Isolation – Guard I

Three-Phase DOE 2016 Efficiency, Aluminum.....10-26

Three-Phase DOE 2016 Efficiency, Copper.....10-27

Noise Isolation – Guard II10-28

Three-Phase DOE 2016 Efficiency, Aluminum.....10-29

Three-Phase DOE 2016 Efficiency, Copper.....10-30

Harmonic Mitigating – Guard III

Three-Phase DOE 2016 Efficiency, Copper.....10-31

Servicenter Mini-Unit Substations –

Integral Transformer and Distribution Center10-32

Single-Phase and Three-Phase DOE 2016 Efficiency10-33

Outlines, Dimensions, Wiring Diagrams.....10-34

Totally Enclosed, Nonventilated – TENV10-35

Aluminum and Copper DOE 2016 Efficiency10-36

Midtapped

Aluminum DOE 2016 Efficiency.....10-37

Copper DOE 2016 Efficiency.....10-38

Drive Isolation

Three-Phase.....10-40

Accessories and Lugs10-42

Enclosure Parts10-44

Wiring Diagrams10-45

Dimensions10-46

General Purpose Transformers in Enclosures

Single-Phase.....10-48

Buck-Boost Encapsulated Transformers10-51

Selection Tables10-54

Connection Diagrams.....10-61

Open Core and Coil Transformers10-62

Machine Tool Applications.....10-63

Control.....10-64

Options and Fusing Guide10-66

Wiring Diagrams10-67

Outlines and Dimensions10-68

CE-Rated.....10-69



Dry Type Transformers

General Information

Types QB, QMS, QL
600 Volts and Below

General Information

The complete family of transformers from GE provide quiet, reliable transformer operation.

All of the dry-type transformers through 1,000 kVA are UL listed under the requirements of Standard 5085 and 1561. In addition, each transformer meets the requirements of NEMA ST-20, 1992. Type IP, QB and QMS models are C-UL listed.

General-purpose transformers are rated 600 Volts and below for supplying appliance, lighting, and power loads from electrical distribution systems. Standard distribution voltages are 600, 480, and 240 Volts; standard load voltages are 480, 240, 208, and 120 Volts. The transformer is used to obtain the load voltage from the distribution voltage. Since no vaults are required for installation, these transformers can be located right at the load to provide the correct voltage for the application. This eliminates the need for long, costly, low-voltage feeders.

Construction

Types QB and QMS

Core and coils are contained within a NEMA 3R nonventilated weatherproof enclosure. Type QB and QMS units feature encapsulated core and coils.

Type QL

Units are enclosed in a NEMA 2 drip-proof painted metal enclosure with natural draft ventilation. The core-and-coil assembly is mounted on rubber isolation pads to reduce noise. Weathershield kits are available for conversion to a NEMA 3R enclosure suitable for outdoor service. NEMA 2 and NEMA 3R stainless steel (Type 316) enclosures are available up to 150kVA. To specify a stainless steel enclosure for an aluminum-wound transformer, substitute the letter "S" in the fifth character of the GE product number. For example, 9T10A1004 changes to 9T10S1004. For copper-wound transformers, substitute the letter "Z" in the fifth character of the GE product number. For example, 9T10C1004 changes to 9T10Z1004. **All QL model product numbers begin with 9T7, 9T8, or 9T1.**

Transformer taps compensate for high or low line voltages. Most standard QL units rated 15kVA through 300kVA and with a primary voltage of 240V or higher have six available voltage taps – four 2.5% taps below the nominal tap and two 2.5% taps above the nominal tap. This arrangement provides a 15% range of tap voltage adjustment. Transformers rated 500kVA and higher have four available voltage taps – two 2.5% taps above the nominal tap and two 2.5% taps below the nominal tap.

Temperature Class

Industry standards classify insulation systems in accordance with the rating system shown below.

Insulation System Classification			
Ambient	+ Winding Rise	+ Hot Spot	= Temp. Class
40°C	55°C	10°C	105°C
40°C	80°C	30°C	150°C
40°C	115°C	25°C	180°C
40°C	150°C	30°C	220°C

All standard, general-purpose, GE transformers meet all applicable NEMA, ANSI, UL, and IEEE standards.

The design life of transformers having different insulation systems is the same, since the allowable temperature rise of an insulation material system is predicated on a specified life for all insulation. The lower temperature systems are designed for the same life as higher temperature systems.

Sound Levels

All general-purpose transformers are as quiet, or quieter than required by NEMA ST-20. Average sound levels are warranted not to exceed the values listed for each load rating shown in the adjacent table. Sound characteristics vary between transformers of identical voltage and kVA rating. The range of variation may be 4 to 8 decibels.

These values apply only to specified test conditions because the characteristic of the installation can cause them to be higher under operating conditions. Where acoustical noise is deemed to be of unusual concern, proper steps should be taken during installation to minimize audible noise transmission.

Sound Levels (Decibels)¹ for 150°C Rise Models

kVA	Sound Levels
0 - 9	40
10 - 50	45
51 - 150	50
151 - 300	55
301 - 500	60

¹Measured per NEMA ST-20.



Dry Type Transformers

General Information

Types QB, QMS, QL
600 Volts and Below

Section 10

Termination

Improved termination spacing and wiring compartment room gives greater flexibility in selecting various UL listed connectors for either copper or aluminum cable.

Product Number Selection Instructions

1. Establish phase and frequency
2. Determine the primary voltage—the voltage presently available
3. Determine the secondary voltage—the voltage needed at the load
4. Determine the kVA load, allowing room for expansion
5. Using the facts determined in the four steps, locate the transformer model in the listings on the following pages.



Type QB, .050 kVA-3 kVA, Single-Phase



Type QMS, 5 kVA-25 kVA, Single-Phase



Type QL, 15 kVA-250 kVA, Single-Phase, DOE 2016 Efficiency,
15 kVA-500 kVA, Three-Phase, DOE 2016 Efficiency



Dry Type Transformers

General Purpose

Aluminum

Single-Phase DOE 2016 Efficiency

Section 10

150°C Rise NEMA 2

Input Voltage	Output Voltage	kVA	Taps	Wiring Diagram No. ¹	Approx. Net Weight (Lbs)	Frame Size	Product Number
240 x 480 Volts	120/240 Volts	15	(+2, -4 2.5%)	23	320	YF171	9T83B2670
		25	(+2, -4 2.5%)	23	320	YF171	9T83B2671
		37.5	(+2, -4 2.5%)	23	320	YF171	9T83B2672
		50	(+2, -4 2.5%)	23	400	YF172	9T83B2673
		75	(+2, -4 2.5%)	23	510	YF174	9T83B2674
		100	(+2, -4 2.5%)	23	900	YF175	9T83B2675
		167	(+2, -4 2.5%)	23	1360	YF176	9T83B2676
		250	(+2, -4 2.5%)	23	1700	YF177	9T83B2677

115°C Rise NEMA 2

Input Voltage	Output Voltage	kVA	Taps	Wiring Diagram No. ¹	Approx. Net Weight (Lbs)	Frame Size	Product Number
240 x 480 Volts	120/240 Volts	15	(+2, -4 2.5%)	23	320	YF171	9T83B2670G15
		25	(+2, -4 2.5%)	23	320	YF171	9T83B2671G15
		37.5	(+2, -4 2.5%)	23	400	YF172	9T83B2672G15
		50	(+2, -4 2.5%)	23	500	XV173	9T83B2673G15
		75	(+2, -4 2.5%)	23	510	YF174	9T83B2674G15
		100	(+2, -4 2.5%)	23	900	YF175	9T83B2675G15
		167	(+2, -4 2.5%)	23	1360	YF176	9T83B2676G15

80°C Rise NEMA 2

Input Voltage	Output Voltage	kVA	Taps	Wiring Diagram No. ¹	Approx. Net Weight (Lbs)	Frame Size	Product Number
240 x 480 Volts	120/240 Volts	15	(+2, -4 2.5%)	23	320	YF171	9T83B2670G80
		25	(+2, -4 2.5%)	23	320	YF171	9T83B2671G80
		37.5	(+2, -4 2.5%)	23	400	YF172	9T83B2672G80
		50	(+2, -4 2.5%)	23	510	YF174	9T83B2673G80
		75	(+2, -4 2.5%)	23	900	YF175	9T83B2674G80
		100	(+2, -4 2.5%)	23	1360	YF176	9T83B2675G80
		167	(+2, -4 2.5%)	23	1700	YF177	9T83B2676G80

¹See page 10-45 for wiring diagrams.



Dry Type Transformers

General Purpose

Copper

Single-Phase DOE 2016 Efficiency

Section 10

150°C Rise NEMA 2

Input Voltage	Output Voltage	kVA	Taps	Wiring Diagram No. ¹	Approx. Net Weight (Lbs)	Frame Size	Product Number
240 x 480 Volts	120/240 Volts	15	(+2, -4 2.5%)	23	350	YF171	9T83C2570
		25	(+2, -4 2.5%)	23	350	YF171	9T83C2571
		37.5	(+2, -4 2.5%)	23	500	YF172	9T83C2572
		50	(+2, -4 2.5%)	23	520	YF173	9T83C2573
		75	(+2, -4 2.5%)	23	635	YF174	9T83C2574
		100	(+2, -4 2.5%)	23	1050	YF175	9T83C2575
		167	(+2, -4 2.5%)	23	1675	YF176	9T83C2576

115°C Rise NEMA 2

Input Voltage	Output Voltage	kVA	Taps	Wiring Diagram No. ¹	Approx. Net Weight (Lbs)	Frame Size	Product Number
240 x 480 Volts	120/240 Volts	15	(+2, -4 2.5%)	23	350	YF171	9T83C2570G15
		25	(+2, -4 2.5%)	23	350	YF171	9T83C2571G15
		37.5	(+2, -4 2.5%)	23	500	YF172	9T83C2572G15
		50	(+2, -4 2.5%)	23	520	YF173	9T83C2573G15
		75	(+2, -4 2.5%)	23	635	YF174	9T83C2574G15
		100	(+2, -4 2.5%)	23	1050	YF175	9T83C2575G15
		167	(+2, -4 2.5%)	23	1675	YF176	9T83C2576G15

80°C Rise NEMA 2

Input Voltage	Output Voltage	kVA	Taps	Wiring Diagram No. ¹	Approx. Net Weight (Lbs)	Frame Size	Product Number
240 x 480 Volts	120/240 Volts	15	(+2, -4 2.5%)	23	350	YF171	9T83C2570G80
		25	(+2, -4 2.5%)	23	350	YF171	9T83C2571G80
		37.5	(+2, -4 2.5%)	23	500	YF172	9T83C2572G80
		50	(+2, -4 2.5%)	23	635	YF174	9T83C2573G80
		75	(+2, -4 2.5%)	23	1050	YF175	9T83C2574G80
		100	(+2, -4 2.5%)	23	1675	YF176	9T83C2575G80
		167	(+2, -4 2.5%)	23	1960	YF177	9T83C2576G80

¹See page 10-45 for wiring diagrams.



Dry Type Transformers

General Purpose

Three-Phase

DOE 2016 Product Number Nomenclature

Section 10

9T	1	0	A	100	1	G31
GE Standard						
1 = QL DOE 2016 Design						
Transformer Type						
0 = Standard, K1						
1 = K13						
2 = K20						
3 = K30						
4 = K4						
7 = Guard II/Servicenter						
8 = Spare Parts						
Coil Material						
A = Aluminum						
C = Copper						
kVA Rating						
1 = 15kVA						
2 = 30kVA						
3 = 45kVA						
4 = 75kVA						
5 = 112.5kVA						
6 = 150kVA						
7 = 225kVA						
8 = 300kVA						
9 = 500kVA						
Voltage Rating						
See Voltage Chart below						

Group Number	
No Group Number Shown = 150°C	G34 = 115°C, Electrostatic Shield†, -3dB
G02 = 150°C, -3dB	G35 = 115°C, -5dB
G03 = 150°C, Electrostatic Shield†	G36 = 115°C, Electrostatic Shield†, -5dB
G04 = 150°C, Electrostatic Shield†, -3dB	G39 = 115°C, Non-STD kVA
G05 = 150°C, -5dB	G40 = 115°C, Non-STD kVA
G06 = 150°C, Electrostatic Shield†, -5dB	G61 = 80°C
G09 = 150°C, Non-STD kVA	G62 = 80°C, -5dB
G10 = 150°C, Non-STD kVA	G63 = 80°C, Electrostatic Shield†
G29 = 140°C, 40°C amb	G64 = 80°C, Electrostatic Shield†, -3dB
G30 = 140°C, 50°C amb	G65 = 80°C, -5dB
G31 = 115°C	G66 = 80°C, Electrostatic Shield†, -5dB
G32 = 115°C, -3dB	G69 = 80°C, Non-STD kVA
G33 = 115°C, Electrostatic Shield†	G70 = 80°C, Non-STD kVA

†An Electrostatic Shield (also called a Guard I transformer) is a grounded, copper-foil barrier between the primary and secondary winding to reduce electrical noise. All K-Factor transformers contain an Electrostatic Shield.

3-Phase Common Voltages

Series	Primary Voltage	Secondary Voltage
100	480	208Y/120
101	480	220
102	480	220Y/127
103	480	208
104	480	230Y/133
105	480	240Y/139
106	480	380
107	480	380Y/219
108	480	400Y/231
109	480	415Y/240
110	480	480
111	480	575
112	480	600
113	480	440Y/254
114	480	600Y/346
115	480	440
116	480	230/115
117	480	480Y/277
118	480	240/120
119	480	240
121	480	220/110
123	480	400
124	480	460
125	480	420
126	480	230
127	480	575Y/332
129	480	460Y/266
131	208	240
132	208	240/120
133	208	480
134	208	480Y/277
135	208	380Y/219
136	208	230
137	208	575
138	208	460
139	208	400Y/231
140	208	208
141	208	230Y/133
142	208	380
143	208	220/110
144	208	220Y/127
145	208	208Y/120
146	208	400
147	208	315
148	208	600
149	208	460Y/266
150	208	220
151	208	230/115
152	208	415Y/240
153	240	480Y/277
154	240	480
155	240	400Y/231

Series	Primary Voltage	Secondary Voltage
157	240	575
158	240	460Y/266
159	240	240Y/139
160	240	600
161	240	208Y/120
162	240	380
163	240	440
164	240	240/120
165	240	380Y/219
166	220	380Y/219
167	220	400Y/231
168	220	240Y/139
169	220	220
170	220	208Y/120
171	220	480Y/277
172	220	440Y/254
173	220	480/240
174	220	480
175	220	415Y/240
176	380	220Y/127
177	380	480
178	380	220
179	380	208Y/120
180	380	415Y/240
181	380	240/120
184	380	480Y/277
185	380	380Y/219
186	380	230Y/133
187	380	240
188	440	220Y/127
189	440	480
190	440	208Y/120
191	440	380
192	440	380Y/219
193	440	400Y/231
194	440	575Y/332
195	440	240/120
196	440	480Y/277
197	440	240
198	230	460
199	230	400Y/231
200	230	400
201	230	480Y/277
202	230	208Y/120
203	230	480
204	400	230Y/133
205	400	380Y/219
206	400	480
207	400	220Y/127
209	400	400Y/231
210	400	208Y/120
211	400	208Y/120

Series	Primary Voltage	Secondary Voltage
212	400	480Y/277
213	415	208Y/120
214	415	460
215	415	220Y/127
216	416	208Y/120
217	416	480Y/277
218	460	208Y/120
219	460	220
221	460	400Y/231
222	460	220Y/127
223	460	230
224	460	575Y/332
225	460	230Y/133
226	460	460Y/266
227	550	208Y/120
228	550	480Y/277
229	575	208Y/120
230	575	480Y/277
231	575	240Y/139
232	575	460
233	575	480
234	575	230Y/133
235	575	230
236	600	240/120
237	600	480
238	600	480Y/277
239	600	240
240	600	208Y/120
241	600	230Y/133
242	600	240Y/139
243	600	208
244	600	600Y/346
245	690	400Y/231
246	690	208Y/120
247	277	415Y/240
248	315	208Y/120
249	320	480Y/277
250	420	480Y/277
251	490	480Y/277
252	500	480Y/277



Dry Type Transformers

General Purpose

Three-Phase

DOE 2016 Product Number Nomenclature

Section 10

3P Servicenter Product Numbers – DOE 2016

Material	KVA	Primary Voltage	Secondary Voltage	Product Number	
AL	15	240	208Y/120	9T17A0001	
	22.5	240	208Y/120	9T17A0002	
	30	240	208Y/120	9T17A0003	
	15	480	208Y/120	9T17A0011	
	22.5	480	208Y/120	9T17A0012	
	30	480	208Y/120	9T17A0013	
	15	600	208Y/120	9T17A0021	
	22.5	600	208Y/120	9T17A0022	
	30	600	208Y/120	9T17A0023	
	CU	15	240	208Y/120	9T17C0004
		22.5	240	208Y/120	9T17C0005
		30	240	208Y/120	9T17C0006
15		480	208Y/120	9T17C0014	
22.5		480	208Y/120	9T17C0015	
30		480	208Y/120	9T17C0016	
15		600	208Y/120	9T17C0024	
22.5		600	208Y/120	9T17C0025	
30		600	208Y/120	9T17C0026	

Guard II Product Numbers – DOE 2016

Material	KVA	Primary Voltage	Secondary Voltage	Product Number
AL	15	480	208Y/120	9T17A1001G03
	30	480	208Y/120	9T17A1002G03
	45	480	208Y/120	9T17A1003G03
	75	480	208Y/120	9T17A1004G03
	112.5	480	208Y/120	9T17A1005G03
CU	15	480	208Y/120	9T17C1001G03
	30	480	208Y/120	9T17C1002G03
	45	480	208Y/120	9T17C1003G03
	75	480	208Y/120	9T17C1004G03
	112.5	480	208Y/120	9T17C1005G03



Dry Type Transformers

General Purpose

Aluminum

Three-Phase DOE 2016 Efficiency

Advantages

- Quiet performance
- No-weld design – an industry first
- Comprehensive factory testing assures quality
- Accessible mounting foot design speeds installation
- Lug kit and ground bar kit included up through 150kVA
- GE's exclusive wood crate packaging helps reduce shipping damage

Key Features

- Unique core and coil design makes QL transformers among the quietest available
- Core and coil assemblies are mounted on rubber isolation pads to reduce noise
- Bolted coil terminations are more reliable than welded terminations, and they eliminate weld failures and problems associated with welding and weld splatter
- Single-piece front/back is easily removable for service
- Accessible mounting flanges with front/back slotted mounting holes make installation easier
- 100% factory tested for shorts and coil integrity, current and loss, voltage, impedance and noise.
- NEMA 2 powder-coat drip-proof enclosure is standard. Weathershield kit is available for conversion to NEMA 3R outdoor.
- NEMA 3R stainless steel enclosure is available up to 150kVA. To specify a stainless steel enclosure, substitute an "S" in the fifth character in the GE catalog number. Example: 9T10A1004 changes to 9T10S1004.



Type QL Transformer

- Seismic qualified to the requirements of ASCE 7.05, IEEE-693-2005 and IBC-2012/CBC-2013
- Copper or aluminum windings
- Copper ground strap
- Robust packaging with top and side protection protects against shipping damage

Applications

- Commercial
- Industrial
- Motors
- Incandescent lighting
- Resistance heating
- Motor generators (without solid state drives)

Transformer Selection Guide

	Standard	Guard I	Guard II	Guard III	K-Factor (K=4)	K-Factor (K=13)	K-Factor (K=20)	K-Factor (K=50)	DIT	Service Center	TENV	Stainless Steel (Type 316) Enclosure
Motors	X	X			X							
Incandescent Lighting	X	X			X							
Resistance Heating	X	X			X							
Motor Generators (without solid state drives)	X	X			X							
HID Lighting					X							
Induction Heaters					X							
Welders					X							
UPS with optional input filtering					X							
PLC & Solid state controls					X							
Multiple receptacle circuits in health care facilities						X						
UPS without optional input filtering						X						
Production or assembly line equipment						X						
Schools & Classroom facilities						X						
Surge Suppression				X								
Office Buildings		X	X	X		X						
SCR Variable Speed Drives							X	X				
Circuits with exclusive data processing equipment			X	X		X	X					
Critical Care facilities			X	X		X	X					
Hospital Operating Rooms			X	X		X	X					
X-ray equipment			X	X		X	X					
Computer Installations			X	X		X	X					
Programmable Controllers			X	X		X	X					
Instrumentation			X	X		X	X					
AC or DC Variable Speed Drives									X			
Rectifier outputs									X			
Temporary Power										X		
Airborne contaminants or dust-laden environments (indoor and outdoor)											X	
Corrosive environments including water/wastewater and salt spray												X



Dry Type Transformers

General Purpose

Aluminum

Three-Phase DOE 2016 Efficiency

Section 10



Type QL Transformer

150°C Rise NEMA 2

Input Voltage	Output Voltage	kVA	Taps	Wiring Diagram No. ¹	Approx. Net Weight (Lbs)	Frame Size	Product Number
480 Volts Delta	208Y/120 Volts	15	(+2, -4 2.5%)	12	231	UX71A	9T10A1001
		30	(+2, -4 2.5%)	12	330	UX72A	9T10A1002
		45	(+2, -4 2.5%)	12	444	UX73A	9T10A1003
		75	(+2, -4 2.5%)	12	561	UY74A	9T10A1004
		112.5	(+2, -4 2.5%)	12	680	DY75A	9T10A1005
		150	(+2, -4 2.5%)	12	1030	DY76A	9T10A1006
		225	(+2, -4 2.5%)	12	1450	DY77A	9T10A1007
		300	(+2, -4 2.5%)	12	1670	DY78A	9T10A1008
		500	(+2, -2 2.5%)	12	2900	DX79A	9T10A1009

115°C Rise NEMA 2

Input Voltage	Output Voltage	kVA	Taps	Wiring Diagram No. ¹	Approx. Net Weight (Lbs)	Frame Size	Product Number
480 Volts Delta	208Y/120 Volts	15	(+2, -4 2.5%)	12	231	UX71A	9T10A1001G31
		30	(+2, -4 2.5%)	12	330	UX72A	9T10A1002G31
		45	(+2, -4 2.5%)	12	444	UX73A	9T10A1003G31
		75	(+2, -4 2.5%)	12	603	UX74A	9T10A1004G31
		112.5	(+2, -4 2.5%)	12	830	DX75A	9T10A1005G31
		150	(+2, -4 2.5%)	12	1250	DX76A	9T10A1006G31
		225	(+2, -4 2.5%)	12	1670	DX77A	9T10A1007G31
		300	(+2, -4 2.5%)	12	1985	DX78A	9T10A1008G31
		500	(+2, -2 2.5%)	12	2900	DX79A	9T10A1009G31

80°C Rise NEMA 2

Input Voltage	Output Voltage	kVA	Taps	Wiring Diagram No. ¹	Approx. Net Weight (Lbs)	Frame Size	Product Number
480 Volts Delta	208Y/120 Volts	15	(+2, -4 2.5%)	12	330	UX72A	9T10A1001G61
		30	(+2, -4 2.5%)	12	444	UX73A	9T10A1002G61
		45	(+2, -4 2.5%)	12	561	UY74A	9T10A1003G61
		75	(+2, -4 2.5%)	12	680	DY75A	9T10A1004G61
		112.5	(+2, -4 2.5%)	12	1030	DY76A	9T10A1005G61
		150	(+2, -4 2.5%)	12	1450	DY77A	9T10A1006G61
		225	(+2, -4 2.5%)	12	1985	DX78A	9T10A1007G61
		300	(+2, -2 2.5%)	12	2900	DX79A	9T10A1008G61

150°C Rise NEMA 2

Input Voltage	Output Voltage	kVA	Taps	Wiring Diagram No. ¹	Approx. Net Weight (Lbs)	Frame Size	Product Number
208 Volts Delta	208Y/120 Volts	15	(+2, -4 2.5%)	12	231	UX71A	9T10A1451
		30	(+2, -4 2.5%)	12	330	UX72A	9T10A1452
		45	(+2, -4 2.5%)	12	561	UY74A	9T10A1453
		75	(+2, -4 2.5%)	12	680	DY75A	9T10A1454
		112.5	(+2, -4 2.5%)	12	1030	DY76A	9T10A1455
		150	(+2, -4 2.5%)	12	1250	DX76A	9T10A1456
		225	(+2, -4 2.5%)	12	1670	DY78A	9T10A1457
		300	(+2, -2 2.5%)	12	2900	DX79A	9T10A1458

¹See page 10-45 for wiring diagrams.



Dry Type Transformers

General Purpose

Aluminum

Three-Phase DOE 2016 Efficiency

Section 10

150°C Rise NEMA 2

Input Voltage	Output Voltage	kVA	Taps	Wiring Diagram No. ¹	Approx. Net Weight (Lbs)	Frame Size	Product Number
208 Volts Delta	480V/277 Volts	15	(+2, -4 2.5%)	12	231	UX71A	9T10A1341
		30	(+2, -4 2.5%)	12	330	UX72A	9T10A1342
		45	(+2, -4 2.5%)	12	561	UY74A	9T10A1343
		75	(+2, -4 2.5%)	12	680	UY74A	9T10A1344
		112.5	(+2, -4 2.5%)	12	1030	DY76A	9T10A1345
		150	(+2, -4 2.5%)	12	1250	DX76A	9T10A1346
		225	(+2, -4 2.5%)	12	1670	DY78A	9T10A1347
		300	(+2, -2 2.5%)	12	2900	DX79A	9T10A1348

150°C Rise NEMA 2

Input Voltage	Output Voltage	kVA	Taps	Wiring Diagram No. ¹	Approx. Net Weight (Lbs)	Frame Size	Product Number
240 Volts Delta	208V/120 Volts	15	(+2, -4 2.5%)	12	231	UX71A	9T10A1611
		30	(+2, -4 2.5%)	12	330	UX72A	9T10A1612
		45	(+2, -4 2.5%)	12	444	UX73A	9T10A1613
		75	(+2, -4 2.5%)	12	561	UY74A	9T10A1614
		112.5	(+2, -4 2.5%)	12	680	DY75A	9T10A1615
		150	(+2, -4 2.5%)	12	1030	DY76A	9T10A1616
		225	(+2, -4 2.5%)	12	1450	DY77A	9T10A1617
		300	(+2, -4 2.5%)	12	1670	DY78A	9T10A1618
		500	(+2, -2 2.5%)	12	2900	DX79A	9T10A1619

150°C Rise NEMA 2

Input Voltage	Output Voltage	kVA	Taps	Wiring Diagram No. ¹	Approx. Net Weight (Lbs)	Frame Size	Product Number
240 Volts Delta	480V/277 Volts	15	(+2, -4 2.5%)	12	231	UX71A	9T10A1531
		30	(+2, -4 2.5%)	12	330	UX72A	9T10A1532
		45	(+2, -4 2.5%)	12	444	UX73A	9T10A1533
		75	(+2, -4 2.5%)	12	561	UY74A	9T10A1534
		112.5	(+2, -4 2.5%)	12	680	DY75A	9T10A1535
		150	(+2, -4 2.5%)	12	1030	DY76A	9T10A1536
		225	(+2, -4 2.5%)	12	1450	DY77A	9T10A1537
		300	(+2, -4 2.5%)	12	1670	DY78A	9T10A1538
		500	(+2, -2 2.5%)	12	2900	DX79A	9T10A1539

150°C Rise NEMA 2

Input Voltage	Output Voltage	kVA	Taps	Wiring Diagram No. ¹	Approx. Net Weight (Lbs)	Frame Size	Product Number
480 Volts Delta	240/120 Volts	15	(+2, -4 2.5%)	19	231	UX71A	9T10A1181
		30	(+2, -4 2.5%)	19	330	UX72A	9T10A1182
		45	(+2, -4 2.5%)	19	444	UX73A	9T10A1183
		75	(+2, -4 2.5%)	19	561	UY74A	9T10A1184
		112.5	(+2, -4 2.5%)	19	830	DX75A	9T10A1185
		150	(+2, -4 2.5%)	19	1030	DY76A	9T10A1186
		225	(+2, -4 2.5%)	19	1450	DY77A	9T10A1187
		300	(+2, -4 2.5%)	19	1670	DY78A	9T10A1188
		500	(+2, -2 2.5%)	19	2900	DX79A	9T10A1189

150°C Rise NEMA 2

Input Voltage	Output Voltage	kVA	Taps	Wiring Diagram No. ¹	Approx. Net Weight (Lbs)	Frame Size	Product Number
480 Volts Delta	480V/277 Volts	15	(+2, -4 2.5%)	12	231	UX71A	9T10A1171
		30	(+2, -4 2.5%)	12	330	UX72A	9T10A1172
		45	(+2, -4 2.5%)	12	444	UX73A	9T10A1173
		75	(+2, -4 2.5%)	12	561	UY74A	9T10A1174
		112.5	(+2, -4 2.5%)	12	680	DY75A	9T10A1175
		150	(+2, -4 2.5%)	12	1030	DY76A	9T10A1176
		225	(+2, -4 2.5%)	12	1450	DY77A	9T10A1177
		300	(+2, -4 2.5%)	12	1670	DY78A	9T10A1178
		500	(+2, -2 2.5%)	12	2900	DX79A	9T10A1179

¹See page 10-45 for wiring diagrams.



Dry Type Transformers

General Purpose

Copper

Three-Phase DOE 2016 Efficiency

Section 10

150°C Rise NEMA 2

Input Voltage	Output Voltage	kVA	Taps	Wiring Diagram No. ¹	Approx. Net Weight (Lbs)	Frame Size	Product Number
480 Volts Delta	240 Volts	15	(+2, -4 2.5%)	13	230	UX71C	9T10C1191
		30	(+2, -4 2.5%)	13	353	UX72C	9T10C1192
		45	(+2, -4 2.5%)	13	480	UX73C	9T10C1193
		75	(+2, -4 2.5%)	13	661	UY74C	9T10C1194
		112.5	(+2, -4 2.5%)	13	790	DY75C	9T10C1195
		150	(+2, -4 2.5%)	13	1085	DY76C	9T10C1196
		225	(+2, -4 2.5%)	13	1610	DY77C	9T10C1197
		300	(+2, -4 2.5%)	13	1970	DY78C	9T10C1198
		500	(+2, -2 2.5%)	13	3720	DX79C	9T10C1199

150°C Rise NEMA 2

Input Voltage	Output Voltage	kVA	Taps	Wiring Diagram No. ¹	Approx. Net Weight (Lbs)	Frame Size	Product Number
600 Volts Delta	208Y/120 Volts	15	(+2, -4 2.5%)	12	230	UX71C	9T10C2401
		30	(+2, -4 2.5%)	12	353	UX72C	9T10C2402
		45	(+2, -4 2.5%)	12	480	UX73C	9T10C2403
		75	(+2, -4 2.5%)	12	661	UY74C	9T10C2404
		112.5	(+2, -4 2.5%)	12	790	DY75C	9T10C2405
		150	(+2, -4 2.5%)	12	1085	DY76C	9T10C2406
		225	(+2, -4 2.5%)	12	1610	DY77C	9T10C2407
		300	(+2, -4 2.5%)	12	1970	DY78C	9T10C2408
		500	(+2, -2 2.5%)	12	3720	DX79C	9T10C2409

150°C Rise NEMA 2

Input Voltage	Output Voltage	kVA	Taps	Wiring Diagram No. ¹	Approx. Net Weight (Lbs)	Frame Size	Product Number
480 Volts Delta	208Y/120 Volts	15	(+2, -4 2.5%)	12	230	UX71C	9T10C1001
		30	(+2, -4 2.5%)	12	353	UX72C	9T10C1002
		45	(+2, -4 2.5%)	12	480	UX73C	9T10C1003
		75	(+2, -4 2.5%)	12	661	UY74C	9T10C1004
		112.5	(+2, -4 2.5%)	12	790	DY75C	9T10C1005
		150	(+2, -4 2.5%)	12	1085	DY76C	9T10C1006
		225	(+2, -4 2.5%)	12	1610	DY77C	9T10C1007
		300	(+2, -4 2.5%)	12	1970	DY78C	9T10C1008
		500	(+2, -2 2.5%)	12	3720	DX79C	9T10C1009

115°C Rise NEMA 2

Input Voltage	Output Voltage	kVA	Taps	Wiring Diagram No. ¹	Approx. Net Weight (Lbs)	Frame Size	Product Number
480 Volts Delta	208Y/120 Volts	15	(+2, -4 2.5%)	12	230	UX71C	9T10C1001G31
		30	(+2, -4 2.5%)	12	353	UX72C	9T10C1002G31
		45	(+2, -4 2.5%)	12	480	UX73C	9T10C1003G31
		75	(+2, -4 2.5%)	12	748	UX74C	9T10C1004G31
		112.5	(+2, -4 2.5%)	12	900	DX75C	9T10C1005G31
		150	(+2, -4 2.5%)	12	1240	DX76C	9T10C1006G31
		225	(+2, -4 2.5%)	12	1847	DY77C	9T10C1007G31
		300	(+2, -4 2.5%)	12	2150	DX78C	9T10C1008G31

80°C Rise NEMA 2

Input Voltage	Output Voltage	kVA	Taps	Wiring Diagram No. ¹	Approx. Net Weight (Lbs)	Frame Size	Product Number
480 Volts Delta	208Y/120 Volts	15	(+2, -4 2.5%)	12	353	UX72C	9T10C1001G61
		30	(+2, -4 2.5%)	12	480	UX73C	9T10C1002G61
		45	(+2, -4 2.5%)	12	661	UY74C	9T10C1003G61
		75	(+2, -4 2.5%)	12	790	DY75C	9T10C1004G61
		112.5	(+2, -4 2.5%)	12	1085	DY76C	9T10C1005G61
		150	(+2, -4 2.5%)	12	1610	DY77C	9T10C1006G61
		225	(+2, -4 2.5%)	12	2150	DX78C	9T10C1007G61
		300	(+2, -2 2.5%)	12	3720	DX79C	9T10C1008G61

¹See page 10-45 for wiring diagrams.



Dry Type Transformers

K-Factor

Aluminum

Three-Phase DOE 2016 Efficiency

Product Description

These type QL transformers have passed the UL K-factor testing program. K-factor is a standardized way to indicate the ability of a transformer to withstand harmonics. These units shall not exceed rated winding temperature rise at full load and rated K-factor. Neutrals are capable of handling 200% of rated secondary phase current.

Full-width copper electrostatic shielding is standard on all GE K-factor rated transformers. Effective coupling capacitance is 30 pf. Common mode noise attenuation averages 120 dB, and transverse mode noise attenuation averages 30 dB.

Application

For commercial applications with significant nonlinear electronic loading, use K=4 for systems with 50% connected nonlinear electronic loads; K=13 for systems with 100% connected nonlinear electronic loads.

Higher K-factor rated units are available for unique applications.



Type QL, UL K-Factor Transformer

K=4 150°C Rise NEMA 2

Input Voltage	Output Voltage	kVA	Taps	Wiring Diagram No. ¹	Approx. Net Weight (Lbs)	Frame Size	Product Number
480 Volts Delta	208V/120 Volts	15	(+2, -4 2.5%)	12	231	UX71A	9T14A1001G03
		30	(+2, -4 2.5%)	12	444	UX73A	9T14A1002G03
		45	(+2, -4 2.5%)	12	444	UX73A	9T14A1003G03
		75	(+2, -4 2.5%)	12	680	DY75A	9T14A1004G03
		112.5	(+2, -4 2.5%)	12	1030	DY76A	9T14A1005G03
		150	(+2, -4 2.5%)	12	1250	DX76A	9T14A1006G03
		225	(+2, -4 2.5%)	12	1670	DY78A	9T14A1007G03
		300	(+2, -2 2.5%)	12	2900	DX79A	9T14A1008G03

K=4 115°C Rise NEMA 2

Input Voltage	Output Voltage	kVA	Taps	Wiring Diagram No. ¹	Approx. Net Weight (Lbs)	Frame Size	Product Number
480 Volts Delta	208V/120 Volts	15	(+2, -4 2.5%)	12	231	UX71A	9T14A1001G33
		30	(+2, -4 2.5%)	12	444	UX73A	9T14A1002G33
		45	(+2, -4 2.5%)	12	561	UY74A	9T14A1003G33
		75	(+2, -4 2.5%)	12	680	DY75A	9T14A1004G33
		112.5	(+2, -4 2.5%)	12	1030	DY76A	9T14A1005G33
		150	(+2, -4 2.5%)	12	1250	DX76A	9T14A1006G33
		225	(+2, -4 2.5%)	12	1670	DY78A	9T14A1007G33
		300	(+2, -2 2.5%)	12	2900	DX79A	9T14A1008G33

K=4 80°C Rise NEMA 2

Input Voltage	Output Voltage	kVA	Taps	Wiring Diagram No. ¹	Approx. Net Weight (Lbs)	Frame Size	Product Number
480 Volts Delta	208V/120 Volts	15	(+2, -4 2.5%)	12	330	UX72A	9T14A1001G63
		30	(+2, -4 2.5%)	12	444	UX73A	9T14A1002G63
		45	(+2, -4 2.5%)	12	561	UY74A	9T14A1003G63
		75	(+2, -4 2.5%)	12	830	DX75A	9T14A1004G63
		112.5	(+2, -4 2.5%)	12	1250	DX76A	9T14A1005G63
		150	(+2, -4 2.5%)	12	1670	DX77A	9T14A1006G63
		225	(+2, -4 2.5%)	12	1670	DY78A	9T14A1007G63

¹See page 10-45 for wiring diagrams.



Dry Type Transformers

K-Factor

Aluminum

Three-Phase DOE 2016 Efficiency

Section 10

K=13 150°C Rise NEMA 2

Input Voltage	Output Voltage	kVA	Taps	Wiring Diagram No. ¹	Approx. Net Weight (Lbs)	Frame Size	Product Number
480 Volts Delta	208Y/120 Volts	15	(+2, -4 2.5%)	12	231	UX71A	9T11A1001G03
		30	(+2, -4 2.5%)	12	444	UX73A	9T11A1002G03
		45	(+2, -4 2.5%)	12	444	UX73A	9T11A1003G03
		75	(+2, -4 2.5%)	12	603	UX74A	9T11A1004G03
		112.5	(+2, -4 2.5%)	12	1030	DY76A	9T11A1005G03
		150	(+2, -4 2.5%)	12	1250	DX76A	9T11A1006G03
		225	(+2, -4 2.5%)	12	1670	DY78A	9T11A1007G03
		300	(+2, -2 2.5%)	12	2900	DX79A	9T11A1008G03

K=13 115°C Rise NEMA 2

Input Voltage	Output Voltage	kVA	Taps	Wiring Diagram No. ¹	Approx. Net Weight (Lbs)	Frame Size	Product Number
480 Volts Delta	208Y/120 Volts	15	(+2, -4 2.5%)	12	231	UX71A	9T11A1001G33
		30	(+2, -4 2.5%)	12	444	UX73A	9T11A1002G33
		45	(+2, -4 2.5%)	12	561	UY74A	9T11A1003G33
		75	(+2, -4 2.5%)	12	680	DY75A	9T11A1004G33
		112.5	(+2, -4 2.5%)	12	1250	DX76A	9T11A1005G33
		150	(+2, -4 2.5%)	12	1450	DY77A	9T11A1006G33
		225	(+2, -4 2.5%)	12	1670	DY78A	9T11A1007G33
		300	(+2, -2 2.5%)	12	2900	DX79A	9T11A1008G33

K=13 80°C Rise NEMA 2

Input Voltage	Output Voltage	kVA	Taps	Wiring Diagram No. ¹	Approx. Net Weight (Lbs)	Frame Size	Product Number
480 Volts Delta	208Y/120 Volts	15	(+2, -4 2.5%)	12	330	UX72A	9T11A1001G63
		30	(+2, -4 2.5%)	12	561	UY74A	9T11A1002G63
		45	(+2, -4 2.5%)	12	561	UY74A	9T11A1003G63
		75	(+2, -4 2.5%)	12	830	DX75A	9T11A1004G63
		112.5	(+2, -4 2.5%)	12	1670	DX77A	9T11A1005G63
		150	(+2, -4 2.5%)	12	1670	DY78A	9T11A1006G63
		225	(+2, -4 2.5%)	12	2900	DX79A	9T11A1007G63

¹See page 10-45 for wiring diagrams.



Dry Type Transformers

K-Factor

Aluminum

Three-Phase DOE 2016 Efficiency

Section 10

K=20 150°C Rise NEMA 2

Input Voltage	Output Voltage	kVA	Taps	Wiring Diagram No. ¹	Approx. Net Weight (Lbs)	Frame Size	Product Number
480 Volts Delta	208Y/120 Volts	15	(+2, -4 2.5%)	12	2	2	9T12A1001G03
		30	(+2, -4 2.5%)	12	2	2	9T12A1002G03
		45	(+2, -4 2.5%)	12	2	2	9T12A1003G03
		75	(+2, -4 2.5%)	12	2	2	9T12A1004G03
		112.5	(+2, -4 2.5%)	12	2	2	9T12A1005G03
		150	(+2, -4 2.5%)	12	2	2	9T12A1006G03
		225	(+2, -4 2.5%)	12	2	2	9T12A1007G03
		300	(+2, -4 2.5%)	12	2	2	9T12A1008G03

K=20 115°C Rise NEMA 2

Input Voltage	Output Voltage	kVA	Taps	Wiring Diagram No. ¹	Approx. Net Weight (Lbs)	Frame Size	Product Number
480 Volts Delta	208Y/120 Volts	15	(+2, -4 2.5%)	12	2	2	9T12A1001G33
		30	(+2, -4 2.5%)	12	2	2	9T12A1002G33
		45	(+2, -4 2.5%)	12	2	2	9T12A1003G33
		75	(+2, -4 2.5%)	12	2	2	9T12A1004G33
		112.5	(+2, -4 2.5%)	12	2	2	9T12A1005G33
		150	(+2, -4 2.5%)	12	2	2	9T12A1006G33
		225	(+2, -4 2.5%)	12	2	2	9T12A1007G33
		300	(+2, -4 2.5%)	12	2	2	9T12A1008G33

K=20 80°C Rise NEMA 2

Input Voltage	Output Voltage	kVA	Taps	Wiring Diagram No. ¹	Approx. Net Weight (Lbs)	Frame Size	Product Number
480 Volts Delta	208Y/120 Volts	15	(+2, -4 2.5%)	12	2	2	9T12A1001G63
		30	(+2, -4 2.5%)	12	2	2	9T12A1002G63
		45	(+2, -4 2.5%)	12	2	2	9T12A1003G63
		75	(+2, -4 2.5%)	12	2	2	9T12A1004G63
		112.5	(+2, -4 2.5%)	12	2	2	9T12A1005G63
		150	(+2, -4 2.5%)	12	2	2	9T12A1006G63
		225	(+2, -4 2.5%)	12	2	2	9T12A1007G63
		300	(+2, -4 2.5%)	12	2	2	9T12A1008G63

¹See page 10-45 for wiring diagrams.

²Call GE Technical Support at 1-800-GE 1-STOP, Option #4



Dry Type Transformers

K-Factor

Aluminum

Three-Phase DOE 2016 Efficiency

Section 10

K=30 150°C Rise NEMA 2

Input Voltage	Output Voltage	kVA	Taps	Wiring Diagram No. ¹	Approx. Net Weight (Lbs)	Frame Size	Product Number
480 Volts Delta	208Y/120 Volts	15	(+2, -4 2.5%)	12	2	2	9T13A1001G03
		30	(+2, -4 2.5%)	12	2	2	9T13A1002G03
		45	(+2, -4 2.5%)	12	2	2	9T13A1003G03
		75	(+2, -4 2.5%)	12	2	2	9T13A1004G03
		112.5	(+2, -4 2.5%)	12	2	2	9T13A1005G03
		150	(+2, -4 2.5%)	12	2	2	9T13A1006G03
		225	(+2, -4 2.5%)	12	2	2	9T13A1007G03
		300	(+2, -4 2.5%)	12	2	2	9T13A1008G03

K=30 115°C Rise NEMA 2

Input Voltage	Output Voltage	kVA	Taps	Wiring Diagram No. ¹	Approx. Net Weight (Lbs)	Frame Size	Product Number
480 Volts Delta	208Y/120 Volts	15	(+2, -4 2.5%)	12	2	2	9T13A1001G33
		30	(+2, -4 2.5%)	12	2	2	9T13A1002G33
		45	(+2, -4 2.5%)	12	2	2	9T13A1003G33
		75	(+2, -4 2.5%)	12	2	2	9T13A1004G33
		112.5	(+2, -4 2.5%)	12	2	2	9T13A1005G33
		150	(+2, -4 2.5%)	12	2	2	9T13A1006G33
		225	(+2, -4 2.5%)	12	2	2	9T13A1007G33
		300	(+2, -4 2.5%)	12	2	2	9T13A1008G33

K=30 80°C Rise NEMA 2

Input Voltage	Output Voltage	kVA	Taps	Wiring Diagram No. ¹	Approx. Net Weight (Lbs)	Frame Size	Product Number
480 Volts Delta	208Y/120 Volts	15	(+2, -4 2.5%)	12	2	2	9T13A1001G63
		30	(+2, -4 2.5%)	12	2	2	9T13A1002G63
		45	(+2, -4 2.5%)	12	2	2	9T13A1003G63
		75	(+2, -4 2.5%)	12	2	2	9T13A1004G63
		112.5	(+2, -4 2.5%)	12	2	2	9T13A1005G63
		150	(+2, -4 2.5%)	12	2	2	9T13A1006G63
		225	(+2, -4 2.5%)	12	2	2	9T13A1007G63
		300	(+2, -4 2.5%)	12	2	2	9T13A1008G63

¹See page 10-45 for wiring diagrams.

²Call GE Technical Support at 1-800-GE 1-STOP, Option #4



Dry Type Transformers

K-Factor

Copper

Three-Phase DOE 2016 Efficiency

Section 10

K=4 150°C Rise NEMA 2

Input Voltage	Output Voltage	kVA	Taps	Wiring Diagram No. ¹	Approx. Net Weight (Lbs)	Frame Size	Product Number
480 Volts Delta	208Y/120 Volts	15	(+2, -4 2.5%)	12	230	UX71C	9T14C1001G03
		30	(+2, -4 2.5%)	12	353	UX72C	9T14C1002G03
		45	(+2, -4 2.5%)	12	480	UX73C	9T14C1003G03
		75	(+2, -4 2.5%)	12	661	UY74C	9T14C1004G03
		112.5	(+2, -4 2.5%)	12	790	DY75C	9T14C1005G03
		150	(+2, -4 2.5%)	12	1610	DY77C	9T14C1006G03
		225	(+2, -4 2.5%)	12	1847	DX77C	9T14C1007G03
		300	(+2, -2 2.5%)	12	3720	DX79C	9T14C1008G03

K=4 115°C Rise NEMA 2

Input Voltage	Output Voltage	kVA	Taps	Wiring Diagram No. ¹	Approx. Net Weight (Lbs)	Frame Size	Product Number
480 Volts Delta	208Y/120 Volts	15	(+2, -4 2.5%)	12	353	UX72C	9T14C1001G33
		30	(+2, -4 2.5%)	12	480	UX73C	9T14C1002G33
		45	(+2, -4 2.5%)	12	661	UY74C	9T14C1003G33
		75	(+2, -4 2.5%)	12	748	UX74C	9T14C1004G33
		112.5	(+2, -4 2.5%)	12	900	DX75C	9T14C1005G33
		150	(+2, -4 2.5%)	12	1610	DY77C	9T14C1006G33
		225	(+2, -4 2.5%)	12	2150	DX78C	9T14C1007G33
		300	(+2, -2 2.5%)	12	3720	DX79C	9T14C1008G33
		500	(+2, -2 2.5%)	12	2	2	9T14C1009G33

K=4 80°C Rise NEMA 2

Input Voltage	Output Voltage	kVA	Taps	Wiring Diagram No. ¹	Approx. Net Weight (Lbs)	Frame Size	Product Number
480 Volts Delta	208Y/120 Volts	15	(+2, -4 2.5%)	12	353	UX72C	9T14C1001G63
		30	(+2, -4 2.5%)	12	480	UX73C	9T14C1002G63
		45	(+2, -4 2.5%)	12	661	UY74C	9T14C1003G63
		75	(+2, -4 2.5%)	12	790	DY75C	9T14C1004G63
		112.5	(+2, -4 2.5%)	12	1085	DY76C	9T14C1005G63
		150	(+2, -4 2.5%)	12	1610	DY77C	9T14C1006G63
		225	(+2, -4 2.5%)	12	2150	DX78C	9T14C1007G63
		300	(+2, -2 2.5%)	12	3720	DX79C	9T14C1008G63

¹See page 10-45 for wiring diagrams.

²Call GE Technical Support at 1-800-GE 1-STOP, Option #4



Dry Type Transformers

K-Factor

Copper

Three-Phase DOE 2016 Efficiency

Section 10

K=13 150°C Rise NEMA 2

Input Voltage	Output Voltage	kVA	Taps	Wiring Diagram No. ¹	Approx. Net Weight (Lbs)	Frame Size	Product Number
480 Volts Delta	208Y/120 Volts	15	(+2, -4 2.5%)	12	230	UX71C	9T11C1001G03
		30	(+2, -4 2.5%)	12	353	UX72C	9T11C1002G03
		45	(+2, -4 2.5%)	12	480	UX73C	9T11C1003G03
		75	(+2, -4 2.5%)	12	790	DY75C	9T11C1004G03
		112.5	(+2, -4 2.5%)	12	790	DY75C	9T11C1005G03
		150	(+2, -4 2.5%)	12	1610	DY77C	9T11C1006G03
		225	(+2, -4 2.5%)	12	2150	DX78C	9T11C1007G03
		300	(+2, -2 2.5%)	12	3720	DX79C	9T11C1008G03

K=13 115°C Rise NEMA 2

Input Voltage	Output Voltage	kVA	Taps	Wiring Diagram No. ¹	Approx. Net Weight (Lbs)	Frame Size	Product Number
480 Volts Delta	208Y/120 Volts	15	(+2, -4 2.5%)	12	353	UX72C	9T11C1001G33
		30	(+2, -4 2.5%)	12	480	UX73C	9T11C1002G33
		45	(+2, -4 2.5%)	12	661	UV74C	9T11C1003G33
		75	(+2, -4 2.5%)	12	790	DY75C	9T11C1004G33
		112.5	(+2, -4 2.5%)	12	1085	DY76C	9T11C1005G33
		150	(+2, -4 2.5%)	12	1610	DY77C	9T11C1006G33
		225	(+2, -4 2.5%)	12	3720	DX79C	9T11C1007G33
		300	(+2, -2 2.5%)	12	3720	DX79C	9T11C1008G33
		500	(+2, -2 2.5%)	12	2	2	9T11C1009G33

K=13 80°C Rise NEMA 2

Input Voltage	Output Voltage	kVA	Taps	Wiring Diagram No. ¹	Approx. Net Weight (Lbs)	Frame Size	Product Number
480 Volts Delta	208Y/120 Volts	15	(+2, -4 2.5%)	12	353	UX72C	9T11C1001G63
		30	(+2, -4 2.5%)	12	480	UX73C	9T11C1002G63
		45	(+2, -4 2.5%)	12	661	UV74C	9T11C1003G63
		75	(+2, -4 2.5%)	12	790	DY75C	9T11C1004G63
		112.5	(+2, -4 2.5%)	12	1085	DY76C	9T11C1005G63
		150	(+2, -4 2.5%)	12	1610	DY77C	9T11C1006G63
		225	(+2, -2 2.5%)	12	3720	DX79C	9T11C1007G63
		300	(+2, -4 2.5%)	12	2	2	9T11C1008G63

¹See page 10-45 for wiring diagrams.

²Call GE Technical Support at 1-800-GE 1-STOP, Option #4



Dry Type Transformers

K-Factor

Copper

Three-Phase DOE 2016 Efficiency

Section 10

K=20 150°C Rise NEMA 2

Input Voltage	Output Voltage	kVA	Taps	Wiring Diagram No. ¹	Approx. Net Weight (Lbs)	Frame Size	Product Number
480 Volts Delta	208Y/120 Volts	15	(+2, -4 2.5%)	12	2	2	9T12C1001G03
		30	(+2, -4 2.5%)	12	2	2	9T12C1002G03
		45	(+2, -4 2.5%)	12	2	2	9T12C1003G03
		75	(+2, -4 2.5%)	12	2	2	9T12C1004G03
		112.5	(+2, -4 2.5%)	12	2	2	9T12C1005G03
		150	(+2, -4 2.5%)	12	2	2	9T12C1006G03
		225	(+2, -4 2.5%)	12	2	2	9T12C1007G03
		300	(+2, -4 2.5%)	12	2	2	9T12C1008G03

K=20 115°C Rise NEMA 2

Input Voltage	Output Voltage	kVA	Taps	Wiring Diagram No. ¹	Approx. Net Weight (Lbs)	Frame Size	Product Number
480 Volts Delta	208Y/120 Volts	15	(+2, -4 2.5%)	12	2	2	9T12C1001G33
		30	(+2, -4 2.5%)	12	2	2	9T12C1002G33
		45	(+2, -4 2.5%)	12	2	2	9T12C1003G33
		75	(+2, -4 2.5%)	12	2	2	9T12C1004G33
		112.5	(+2, -4 2.5%)	12	2	2	9T12C1005G33
		150	(+2, -4 2.5%)	12	2	2	9T12C1006G33
		225	(+2, -4 2.5%)	12	2	2	9T12C1007G33
		300	(+2, -4 2.5%)	12	2	2	9T12C1008G33

K=20 80°C Rise NEMA 2

Input Voltage	Output Voltage	kVA	Taps	Wiring Diagram No. ¹	Approx. Net Weight (Lbs)	Frame Size	Product Number
480 Volts Delta	208Y/120 Volts	15	(+2, -4 2.5%)	12	2	2	9T12C1001G63
		30	(+2, -4 2.5%)	12	2	2	9T12C1002G63
		45	(+2, -4 2.5%)	12	2	2	9T12C1003G63
		75	(+2, -4 2.5%)	12	2	2	9T12C1004G63
		112.5	(+2, -4 2.5%)	12	2	2	9T12C1005G63
		150	(+2, -4 2.5%)	12	2	2	9T12C1006G63

¹See page 10-45 for wiring diagrams.

²Call GE Technical Support at 1-800-GE 1-STOP, Option #4



Dry Type Transformers

K-Factor

Copper

Three-Phase DOE 2016 Efficiency

Section 10

K=30 150°C Rise NEMA 2

Input Voltage	Output Voltage	kVA	Taps	Wiring Diagram No. ¹	Approx. Net Weight (Lbs)	Frame Size	Product Number
480 Volts Delta	208Y/120 Volts	15	(+2, -4 2.5%)	12	2	2	9T13C1001G03
		30	(+2, -4 2.5%)	12	2	2	9T13C1002G03
		45	(+2, -4 2.5%)	12	2	2	9T13C1003G03
		75	(+2, -4 2.5%)	12	2	2	9T13C1004G03
		112.5	(+2, -4 2.5%)	12	2	2	9T13C1005G03
		150	(+2, -4 2.5%)	12	2	2	9T13C1006G03
		225	(+2, -4 2.5%)	12	2	2	9T13C1007G03

K=30 115°C Rise NEMA 2

Input Voltage	Output Voltage	kVA	Taps	Wiring Diagram No. ¹	Approx. Net Weight (Lbs)	Frame Size	Product Number
480 Volts Delta	208Y/120 Volts	15	(+2, -4 2.5%)	12	2	2	9T13C1001G33
		30	(+2, -4 2.5%)	12	2	2	9T13C1002G33
		45	(+2, -4 2.5%)	12	2	2	9T13C1003G33
		75	(+2, -4 2.5%)	12	2	2	9T13C1004G33
		112.5	(+2, -4 2.5%)	12	2	2	9T13C1005G33
		150	(+2, -4 2.5%)	12	2	2	9T13C1006G33
		225	(+2, -4 2.5%)	12	2	2	9T13C1007G33

K=30 80°C Rise NEMA 2

Input Voltage	Output Voltage	kVA	Taps	Wiring Diagram No. ¹	Approx. Net Weight (Lbs)	Frame Size	Product Number
480 Volts Delta	208Y/120 Volts	15	(+2, -4 2.5%)	12	2	2	9T13C1001G63
		30	(+2, -4 2.5%)	12	2	2	9T13C1002G63
		45	(+2, -4 2.5%)	12	2	2	9T13C1003G63
		75	(+2, -4 2.5%)	12	2	2	9T13C1004G63
		150	(+2, -4 2.5%)	12	2	2	9T13C1006G63

¹See page 10-45 for wiring diagrams.

²Call GE Technical Support at 1-800-GE 1-STOP, Option #4



Dry Type Transformers

K-Factor Low Noise (-3dB below NEMA ST-20 Standard)

Aluminum

Three-Phase DOE 2016 Efficiency

Section 10

K=4 150°C Rise

Input Voltage	Output Voltage	kVA	Taps	Wiring Diagram No. ¹	Approx. Net Weight (Lbs)	Frame Size	Product Number
480 Volts Delta	208Y/120 Volts	15	(+2, -4 2.5%)	12	231	UX71A	9T14A1001G04
		30	(+2, -4 2.5%)	12	444	UX73A	9T14A1002G04
		45	(+2, -4 2.5%)	12	444	UX73A	9T14A1003G04
		75	(+2, -4 2.5%)	12	603	UX74A	9T14A1004G04
		112.5	(+2, -4 2.5%)	12	1030	DY76A	9T14A1005G04
		150	(+2, -4 2.5%)	12	1250	DX76A	9T14A1006G04
		225	(+2, -4 2.5%)	12	1670	DY78A	9T14A1007G04
		300	(+2, -2 2.5%)	12	2900	DX79A	9T14A1008G04

K=4 115°C Rise

Input Voltage	Output Voltage	kVA	Taps	Wiring Diagram No. ¹	Approx. Net Weight (Lbs)	Frame Size	Product Number
480 Volts Delta	208Y/120 Volts	15	(+2, -4 2.5%)	12	231	UX71A	9T14A1001G34
		30	(+2, -4 2.5%)	12	444	UX73A	9T14A1002G34
		45	(+2, -4 2.5%)	12	561	UY74A	9T14A1003G34
		75	(+2, -4 2.5%)	12	680	DY75A	9T14A1004G34
		112.5	(+2, -4 2.5%)	12	1030	DY76A	9T14A1005G34
		150	(+2, -4 2.5%)	12	1250	DX76A	9T14A1006G34
		225	(+2, -4 2.5%)	12	1670	DY78A	9T14A1007G34
		300	(+2, -2 2.5%)	12	2900	DX79A	9T14A1008G34

K=4 80°C Rise

Input Voltage	Output Voltage	kVA	Taps	Wiring Diagram No. ¹	Approx. Net Weight (Lbs)	Frame Size	Product Number
480 Volts Delta	208Y/120 Volts	15	(+2, -4 2.5%)	12	330	UX72A	9T14A1001G64
		30	(+2, -4 2.5%)	12	444	UX73A	9T14A1002G64
		45	(+2, -4 2.5%)	12	561	UY74A	9T14A1003G64
		75	(+2, -4 2.5%)	12	830	DX75A	9T14A1004G64
		112.5	(+2, -4 2.5%)	12	1250	DX76A	9T14A1005G62
		150	(+2, -4 2.5%)	12	1670	DX77A	9T14A1006G62
		225	(+2, -4 2.5%)	12	1670	DY78A	9T14A1007G64
		300	(+2, -2 2.5%)	12	2900	DX79A	9T14A1008G64

K=13 150°C Rise

Input Voltage	Output Voltage	kVA	Taps	Wiring Diagram No. ¹	Approx. Net Weight (Lbs)	Frame Size	Product Number
480 Volts Delta	208Y/120 Volts	15	(+2, -4 2.5%)	12	231	UX71A	9T11A1001G04
		30	(+2, -4 2.5%)	12	444	UX73A	9T11A1002G04
		45	(+2, -4 2.5%)	12	444	UX73A	9T11A1003G04
		75	(+2, -4 2.5%)	12	603	UX74A	9T11A1004G04
		112.5	(+2, -4 2.5%)	12	1030	DY76A	9T11A1005G04
		150	(+2, -4 2.5%)	12	1250	DX76A	9T11A1006G04
		225	(+2, -4 2.5%)	12	1670	DY78A	9T11A1007G04
		300	(+2, -2 2.5%)	12	2900	DX79A	9T11A1008G04

K=13 115°C Rise

Input Voltage	Output Voltage	kVA	Taps	Wiring Diagram No. ¹	Approx. Net Weight (Lbs)	Frame Size	Product Number
480 Volts Delta	208Y/120 Volts	15	(+2, -4 2.5%)	12	231	UX71A	9T11A1001G34
		30	(+2, -4 2.5%)	12	444	UX73A	9T11A1002G34
		45	(+2, -4 2.5%)	12	561	UY74A	9T11A1003G34
		75	(+2, -4 2.5%)	12	680	DY75A	9T11A1004G34
		112.5	(+2, -4 2.5%)	12	1250	DX76A	9T11A1005G34
		150	(+2, -4 2.5%)	12	1450	DY77A	9T11A1006G34
		225	(+2, -4 2.5%)	12	1670	DY78A	9T11A1007G34
		300	(+2, -2 2.5%)	12	2900	DX79A	9T11A1008G34

K=13 80°C Rise

Input Voltage	Output Voltage	kVA	Taps	Wiring Diagram No. ¹	Approx. Net Weight (Lbs)	Frame Size	Product Number
480 Volts Delta	208Y/120 Volts	15	(+2, -4 2.5%)	12	330	UX72A	9T11A1001G64
		30	(+2, -4 2.5%)	12	561	UY74A	9T11A1002G64
		45	(+2, -4 2.5%)	12	561	UY74A	9T11A1003G64
		75	(+2, -4 2.5%)	12	680	DY75A	9T11A1004G64
		112.5	(+2, -4 2.5%)	12	1670	DX77A	9T11A1005G64
		150	(+2, -4 2.5%)	12	1670	DY78A	9T11A1006G64

¹See page 10-45 for wiring diagrams.



Dry Type Transformers

K-Factor Low Noise (-3 dB below NEMA ST-20 Standard)

Aluminum

Three-Phase DOE 2016 Efficiency

Section 10

K=20 150°C Rise

Input Voltage	Output Voltage	kVA	Taps	Wiring Diagram No. ¹	Approx. Net Weight (Lbs)	Frame Size	Product Number
480 Volts Delta	208Y/120 Volts	15	(+2, -4 2.5%)	12	2	2	9T12A1001G04
		30	(+2, -4 2.5%)	12	2	2	9T12A1002G04
		45	(+2, -4 2.5%)	12	2	2	9T12A1003G04
		75	(+2, -4 2.5%)	12	2	2	9T12A1004G04
		112.5	(+2, -4 2.5%)	12	2	2	9T12A1005G04
		150	(+2, -4 2.5%)	12	2	2	9T12A1006G04
		225	(+2, -4 2.5%)	12	2	2	9T12A1007G04

K=20 115°C Rise

Input Voltage	Output Voltage	kVA	Taps	Wiring Diagram No. ¹	Approx. Net Weight (Lbs)	Frame Size	Product Number
480 Volts Delta	208Y/120 Volts	15	(+2, -4 2.5%)	12	2	2	9T12A1001G34
		30	(+2, -4 2.5%)	12	2	2	9T12A1002G34
		45	(+2, -4 2.5%)	12	2	2	9T12A1003G34
		75	(+2, -4 2.5%)	12	2	2	9T12A1004G34
		112.5	(+2, -4 2.5%)	12	2	2	9T12A1005G34

K=20 80°C Rise

Input Voltage	Output Voltage	kVA	Taps	Wiring Diagram No. ¹	Approx. Net Weight (Lbs)	Frame Size	Product Number
480 Volts Delta	208Y/120 Volts	15	(+2, -4 2.5%)	12	2	2	9T12A1001G64
		30	(+2, -4 2.5%)	12	2	2	9T12A1002G64
		45	(+2, -4 2.5%)	12	2	2	9T12A1003G64
		75	(+2, -4 2.5%)	12	2	2	9T12A1004G64
		112.5	(+2, -4 2.5%)	12	2	2	9T12A1005G64

K=30 150°C Rise

Input Voltage	Output Voltage	kVA	Taps	Wiring Diagram No. ¹	Approx. Net Weight (Lbs)	Frame Size	Product Number
480 Volts Delta	208Y/120 Volts	15	(+2, -4 2.5%)	12	2	2	9T13A1001G04
		30	(+2, -4 2.5%)	12	2	2	9T13A1002G04
		45	(+2, -4 2.5%)	12	2	2	9T13A1003G04
		75	(+2, -4 2.5%)	12	2	2	9T13A1004G04
		112.5	(+2, -4 2.5%)	12	2	2	9T13A1005G04
		150	(+2, -4 2.5%)	12	2	2	9T13A1006G04

K=30 115°C Rise

Input Voltage	Output Voltage	kVA	Taps	Wiring Diagram No. ¹	Approx. Net Weight (Lbs)	Frame Size	Product Number
480 Volts Delta	208Y/120 Volts	15	(+2, -4 2.5%)	12	2	2	9T13A1001G34
		30	(+2, -4 2.5%)	12	2	2	9T13A1002G34
		45	(+2, -4 2.5%)	12	2	2	9T13A1003G34
		75	(+2, -4 2.5%)	12	2	2	9T13A1004G34
		112.5	(+2, -4 2.5%)	12	2	2	9T13A1005G34

¹See page 10-45 for wiring diagrams.

²Call GE Technical Support at 1-800-GE 1-STOP, Option #4



Dry Type Transformers K-Factor Low Noise (-3 dB below NEMA ST-20 Standard)

Section 10

Copper

Three-Phase DOE 2016 Efficiency

K = 4 150°C Rise

Input Voltage	Output Voltage	kVA	Taps	Wiring Diagram No. ¹	Approx. Net Weight (Lbs)	Frame Size	Product Number
480 Volts Delta	208Y/120 Volts	15	(+2, -4 2.5%)	12	230	UX71C	9T14C1001G04
		30	(+2, -4 2.5%)	12	353	UX72C	9T14C1002G04
		45	(+2, -4 2.5%)	12	480	UX73C	9T14C1003G04
		75	(+2, -4 2.5%)	12	661	UY74C	9T14C1004G04
		112.5	(+2, -4 2.5%)	12	790	DY75C	9T14C1005G04
		150	(+2, -4 2.5%)	12	1610	DY77C	9T14C1006G04
		225	(+2, -4 2.5%)	12	1970	DY78C	9T14C1007G04
		300	(+2, -2 2.5%)	12	3720	DX79C	9T14C1008G04

K = 4 115°C Rise

Input Voltage	Output Voltage	kVA	Taps	Wiring Diagram No. ¹	Approx. Net Weight (Lbs)	Frame Size	Product Number
480 Volts Delta	208Y/120 Volts	15	(+2, -4 2.5%)	12	353	UX72C	9T14C1001G34
		30	(+2, -4 2.5%)	12	353	UX72C	9T14C1002G34
		45	(+2, -4 2.5%)	12	661	UY74C	9T14C1003G34
		75	(+2, -4 2.5%)	12	790	DY75C	9T14C1004G34
		112.5	(+2, -4 2.5%)	12	900	DX75C	9T14C1005G34
		150	(+2, -4 2.5%)	12	1610	DY77C	9T14C1006G34
		225	(+2, -4 2.5%)	12	2150	DX78C	9T14C1007G34
		300	(+2, -2 2.5%)	12	3720	DX79C	9T14C1008G34

K = 4 80°C Rise

Input Voltage	Output Voltage	kVA	Taps	Wiring Diagram No. ¹	Approx. Net Weight (Lbs)	Frame Size	Product Number
480 Volts Delta	208Y/120 Volts	15	(+2, -4 2.5%)	12	353	UX72C	9T14C1001G64
		30	(+2, -4 2.5%)	12	480	UX73C	9T14C1002G64
		45	(+2, -4 2.5%)	12	661	UY74C	9T14C1003G64
		75	(+2, -4 2.5%)	12	790	DY75C	9T14C1004G64
		112.5	(+2, -4 2.5%)	12	1240	DX76C	9T14C1005G64
		150	(+2, -4 2.5%)	12	1610	DY77C	9T14C1006G64
		225	(+2, -4 2.5%)	12	3720	DX79C	9T14C1007G64
		225	(+2, -2 2.5%)	12	3720	DX79C	9T14C1007G64

K = 13 150°C Rise

Input Voltage	Output Voltage	kVA	Taps	Wiring Diagram No. ¹	Approx. Net Weight (Lbs)	Frame Size	Product Number
480 Volts Delta	208Y/120 Volts	15	(+2, -4 2.5%)	12	230	UX71C	9T11C1001G04
		30	(+2, -4 2.5%)	12	353	UX72C	9T11C1002G04
		45	(+2, -4 2.5%)	12	480	UX73C	9T11C1003G04
		75	(+2, -4 2.5%)	12	790	DY75C	9T11C1004G04
		112.5	(+2, -4 2.5%)	12	790	DY75C	9T11C1005G04
		150	(+2, -4 2.5%)	12	1610	DY77C	9T11C1006G04
		225	(+2, -4 2.5%)	12	1970	DY78C	9T11C1007G04
		300	(+2, -2 2.5%)	12	3720	DX79C	9T11C1008G04

K = 13 115°C Rise

Input Voltage	Output Voltage	kVA	Taps	Wiring Diagram No. ¹	Approx. Net Weight (Lbs)	Frame Size	Product Number
480 Volts Delta	208Y/120 Volts	15	(+2, -4 2.5%)	12	353	UX72C	9T11C1001G34
		30	(+2, -4 2.5%)	12	480	UX73C	9T11C1002G34
		45	(+2, -4 2.5%)	12	661	UY74C	9T11C1003G34
		75	(+2, -4 2.5%)	12	790	DY75C	9T11C1004G34
		112.5	(+2, -4 2.5%)	12	1085	DY76C	9T11C1005G34
		150	(+2, -4 2.5%)	12	1610	DY77C	9T11C1006G34
		225	(+2, -2 2.5%)	12	3720	DX79C	9T11C1007G34
		300	(+2, -2 2.5%)	12	3720	DX79C	9T11C1008G34

K = 13 80°C Rise

Input Voltage	Output Voltage	kVA	Taps	Wiring Diagram No. ¹	Approx. Net Weight (Lbs)	Frame Size	Product Number
480 Volts Delta	208Y/120 Volts	15	(+2, -4 2.5%)	12	353	UX72C	9T11C1001G64
		30	(+2, -4 2.5%)	12	661	UY74C	9T11C1002G64
		45	(+2, -4 2.5%)	12	661	UY74C	9T11C1003G64
		75	(+2, -4 2.5%)	12	790	DY75C	9T11C1004G64
		112.5	(+2, -4 2.5%)	12	1240	DX76C	9T11C1005G64
		150	(+2, -4 2.5%)	12	1610	DY77C	9T11C1006G64
		225	(+2, -4 2.5%)	12	3720	DX79C	9T11C1007G64
		225	(+2, -2 2.5%)	12	3720	DX79C	9T11C1007G64

¹See page 10-45 for wiring diagrams.



Dry Type Transformers

K-Factor Low Noise (-3 dB below NEMA ST-20 Standard)

Section 10

Copper

Three-Phase DOE 2016 Efficiency

K = 20 150°C Rise

Input Voltage	Output Voltage	kVA	Taps	Wiring Diagram No. ¹	Approx. Net Weight (Lbs)	Frame Size	Product Number
480 Volts Delta	208V/120 Volts	15	(+2, -4 2.5%)	12	2	2	9T12C1001G04
		30	(+2, -4 2.5%)	12	2	2	9T12C1002G04
		45	(+2, -4 2.5%)	12	2	2	9T12C1003G04
		75	(+2, -4 2.5%)	12	2	2	9T12C1004G04
		112.5	(+2, -4 2.5%)	12	2	2	9T12C1005G04
		150	(+2, -4 2.5%)	12	2	2	9T12C1006G04

K = 20 115°C Rise

Input Voltage	Output Voltage	kVA	Taps	Wiring Diagram No. ¹	Approx. Net Weight (Lbs)	Frame Size	Product Number
480 Volts Delta	208V/120 Volts	15	(+2, -4 2.5%)	12	2	2	9T12C1001G34
		30	(+2, -4 2.5%)	12	2	2	9T12C1002G34
		45	(+2, -4 2.5%)	12	2	2	9T12C1003G34
		75	(+2, -4 2.5%)	12	2	2	9T12C1004G34
		112.5	(+2, -4 2.5%)	12	2	2	9T12C1005G34
		150	(+2, -4 2.5%)	12	2	2	9T12C1006G34

K = 20 80°C Rise

Input Voltage	Output Voltage	kVA	Taps	Wiring Diagram No. ¹	Approx. Net Weight (Lbs)	Frame Size	Product Number
480 Volts Delta	208V/120 Volts	15	(+2, -4 2.5%)	12	2	2	9T12C1001G64
		30	(+2, -4 2.5%)	12	2	2	9T12C1002G64
		45	(+2, -4 2.5%)	12	2	2	9T12C1003G64
		75	(+2, -4 2.5%)	12	2	2	9T12C1004G64
		112.5	(+2, -4 2.5%)	12	2	2	9T12C1005G64

K = 30 150°C Rise

Input Voltage	Output Voltage	kVA	Taps	Wiring Diagram No. ¹	Approx. Net Weight (Lbs)	Frame Size	Product Number
480 Volts Delta	208V/120 Volts	15	(+2, -4 2.5%)	12	2	2	9T13C1001G04
		30	(+2, -4 2.5%)	12	2	2	9T13C1002G04
		45	(+2, -4 2.5%)	12	2	2	9T13C1003G04
		75	(+2, -4 2.5%)	12	2	2	9T13C1004G04
		112.5	(+2, -4 2.5%)	12	2	2	9T13C1005G04
		150	(+2, -4 2.5%)	12	2	2	9T13C1006G04

K = 30 115°C Rise

Input Voltage	Output Voltage	kVA	Taps	Wiring Diagram No. ¹	Approx. Net Weight (Lbs)	Frame Size	Product Number
480 Volts Delta	208V/120 Volts	15	(+2, -4 2.5%)	12	2	2	9T13C1001G34
		30	(+2, -4 2.5%)	12	2	2	9T13C1002G34
		45	(+2, -4 2.5%)	12	2	2	9T13C1003G34
		75	(+2, -4 2.5%)	12	2	2	9T13C1004G34
		112.5	(+2, -4 2.5%)	12	2	2	9T13C1005G34

¹See page 10-45 for wiring diagrams.

²Call GE Technical Support at 1-800-GE 1-STOP, Option #4



Dry Type Transformers

Low Noise (-3 dB below NEMA ST-20 Standard)

Aluminum

Three-Phase DOE 2016 Efficiency

Product Description

These low noise transformers are designed to operate at reduced noise levels. The vibrations within the magnetic steel core have been greatly reduced, thus lowering the humming of the transformer 3 dB less than NEMA/ANSI standards. Available in Aluminum or Copper windings, with either a 150°C, 115°C or 80°C rise.

Application

Type QL low noise transformers are ideal when quiet operation is required such as near offices, in school buildings, or hospitals. Although they are inherently quieter, installation can greatly influence their noise level and therefore care should be taken in following acoustical principles as well as proper installation procedures. Closets and corners should be avoided as they act as megaphones by seemingly increasing noise levels.



Type QL Low Noise Transformer (front panel removed)

150°C Rise NEMA 2

Input Voltage	Output Voltage	kVA	Taps	Wiring Diagram No. ¹	Approx Net Weight (Lbs)	Frame Size	Product Number
480 Volts Delta	208Y/120 Volts	15	(+2, -4 2.5%)	12	231	UX71A	9T10A1001G02
		30	(+2, -4 2.5%)	12	330	UX72A	9T10A1002G02
		45	(+2, -4 2.5%)	12	444	UX73A	9T10A1003G02
		75	(+2, -4 2.5%)	12	561	UY74A	9T10A1004G02
		112.5	(+2, -4 2.5%)	12	680	DY75A	9T10A1005G02
		150	(+2, -4 2.5%)	12	1030	DY76A	9T10A1006G02
		225	(+2, -4 2.5%)	12	1450	DY77A	9T10A1007G02
		300	(+2, -4 2.5%)	12	1670	DY78A	9T10A1008G02
		500	(+2, -2 2.5%)	12	2900	DX79A	9T10A1009G02

115°C Rise NEMA 2

Input Voltage	Output Voltage	kVA	Taps	Wiring Diagram No. ¹	Approx Net Weight (Lbs)	Frame Size	Product Number
480 Volts Delta	208Y/120 Volts	15	(+2, -4 2.5%)	12	231	UX71A	9T10A1001G32
		30	(+2, -4 2.5%)	12	330	UX72A	9T10A1002G32
		45	(+2, -4 2.5%)	12	444	UX73A	9T10A1003G32
		75	(+2, -4 2.5%)	12	603	UX74A	9T10A1004G32
		112.5	(+2, -4 2.5%)	12	830	DX75A	9T10A1005G32
		150	(+2, -4 2.5%)	12	1250	DX76A	9T10A1006G32
		225	(+2, -4 2.5%)	12	1670	DX77A	9T10A1007G32
		300	(+2, -4 2.5%)	12	1985	DX78A	9T10A1008G32
		500	(+2, -2 2.5%)	12	2900	DX79A	9T10A1009G32

80°C Rise NEMA 2

Input Voltage	Output Voltage	kVA	Taps	Wiring Diagram No. ¹	Approx Net Weight (Lbs)	Frame Size	Product Number
480 Volts Delta	208Y/120 Volts	15	(+2, -4 2.5%)	12	330	UX72A	9T10A1001G62
		30	(+2, -4 2.5%)	12	444	UX73A	9T10A1002G62
		45	(+2, -4 2.5%)	12	561	UY74A	9T10A1003G62
		75	(+2, -4 2.5%)	12	680	DY75A	9T10A1004G62
		112.5	(+2, -4 2.5%)	12	1030	DY76A	9T10A1005G62
		150	(+2, -4 2.5%)	12	1450	DY77A	9T10A1006G62
		225	(+2, -4 2.5%)	12	1985	DX78A	9T10A1007G62
		300	(+2, -2 2.5%)	12	2900	DX79A	9T10A1008G62

¹See page 10-45 for wiring diagrams.

²Call GE Technical Support at 1-800-GE 1-STOP, Option #4



Dry Type Transformers Low Noise (-3 dB below NEMA ST-20 Standard)

Section 10

Copper

Three-Phase DOE 2016 Efficiency

150°C Rise NEMA 2

Input Voltage	Output Voltage	kVA	Taps	Wiring Diagram No. ¹	Approx Net Weight (Lbs)	Frame Size	Product Number
480 Volts Delta	208Y/120 Volts	15	(+2, -4 2.5%)	12	230	UX71C	9T10C1001G02
		30	(+2, -4 2.5%)	12	353	UX72C	9T10C1002G02
		45	(+2, -4 2.5%)	12	480	UX73C	9T10C1003G02
		75	(+2, -4 2.5%)	12	661	UY74C	9T10C1004G02
		112.5	(+2, -4 2.5%)	12	790	DY75C	9T10C1005G02
		150	(+2, -4 2.5%)	12	1085	DY76C	9T10C1006G02
		225	(+2, -4 2.5%)	12	1610	DY77C	9T10C1007G02
		300	(+2, -4 2.5%)	12	1970	DY78C	9T10C1008G02
		500	(+2, -2 2.5%)	12	3720	DX79C	9T10C1009G02

115°C Rise NEMA 2

Input Voltage	Output Voltage	kVA	Taps	Wiring Diagram No. ¹	Approx Net Weight (Lbs)	Frame Size	Product Number
480 Volts Delta	208Y/120 Volts	15	(+2, -4 2.5%)	12	230	UX71C	9T10C1001G32
		30	(+2, -4 2.5%)	12	353	UX72C	9T10C1002G32
		45	(+2, -4 2.5%)	12	480	UX73C	9T10C1003G32
		75	(+2, -4 2.5%)	12	748	UX74C	9T10C1004G32
		112.5	(+2, -4 2.5%)	12	900	DX75C	9T10C1005G32
		150	(+2, -4 2.5%)	12	1240	DX76C	9T10C1006G32
		225	(+2, -4 2.5%)	12	1847	DX77C	9T10C1007G32
		300	(+2, -4 2.5%)	12	2150	DX78C	9T10C1008G32
		500	(+2, -2 2.5%)	12	3720	DX79C	9T10C1009G32

80°C Rise NEMA 2

Input Voltage	Output Voltage	kVA	Taps	Wiring Diagram No. ¹	Approx Net Weight (Lbs)	Frame Size	Product Number
480 Volts Delta	208Y/120 Volts	15	(+2, -4 2.5%)	12	353	UX72C	9T10C1001G62
		30	(+2, -4 2.5%)	12	480	UX73C	9T10C1002G62
		45	(+2, -4 2.5%)	12	661	UY74C	9T10C1003G62
		75	(+2, -4 2.5%)	12	790	DY75C	9T10C1004G62
		112.5	(+2, -4 2.5%)	12	1085	DY76C	9T10C1005G62
		150	(+2, -4 2.5%)	12	1610	DY77C	9T10C1006G62
		225	(+2, -4 2.5%)	12	2150	DX78C	9T10C1007G62
		300	(+2, -4 2.5%)	12	3720	DX79C	9T10C1008G62

¹See page 10-45 for wiring diagrams.



Dry Type Transformers Noise Isolation – Guard I (Electrostatic Shield)

Section 10

Aluminum

Three-Phase DOE 2016 Efficiency

150°C Rise NEMA 2

Input Voltage	Output Voltage	kVA	Taps	Wiring Diagram No. ¹	Approx Net Weight (Lbs)	Frame Size	Product Number
480 Volts Delta	208Y/120 Volts	15	(+2, -4 2.5%)	12	231	UX71A	9T10A1001G03
		30	(+2, -4 2.5%)	12	330	UX72A	9T10A1002G03
		45	(+2, -4 2.5%)	12	444	UX73A	9T10A1003G03
		75	(+2, -4 2.5%)	12	561	UY74A	9T10A1004G03
		112.5	(+2, -4 2.5%)	12	680	DY75A	9T10A1005G03
		150	(+2, -4 2.5%)	12	1030	DY76A	9T10A1006G03
		225	(+2, -4 2.5%)	12	1450	DY77A	9T10A1007G03
		300	(+2, -4 2.5%)	12	1670	DY78A	9T10A1008G03
		500	(+2, -2 2.5%)	12	2900	DX79A	9T10A1009G03

115°C Rise NEMA 2

Input Voltage	Output Voltage	kVA	Taps	Wiring Diagram No. ¹	Approx Net Weight (Lbs)	Frame Size	Product Number
480 Volts Delta	208Y/120 Volts	15	(+2, -4 2.5%)	12	231	UX71A	9T10A1001G33
		30	(+2, -4 2.5%)	12	330	UX72A	9T10A1002G33
		45	(+2, -4 2.5%)	12	444	UX73A	9T10A1003G33
		75	(+2, -4 2.5%)	12	603	UX74A	9T10A1004G33
		112.5	(+2, -4 2.5%)	12	830	DX75A	9T10A1005G33
		150	(+2, -4 2.5%)	12	1250	DX76A	9T10A1006G33
		225	(+2, -4 2.5%)	12	1670	DX77A	9T10A1007G33
		300	(+2, -4 2.5%)	12	1985	DX78A	9T10A1008G33
		500	(+2, -2 2.5%)	12	2900	DX79A	9T10A1009G33

80°C Rise NEMA 2

Input Voltage	Output Voltage	kVA	Taps	Wiring Diagram No. ¹	Approx Net Weight (Lbs)	Frame Size	Product Number
480 Volts Delta	208Y/120 Volts	15	(+2, -4 2.5%)	12	330	UX72A	9T10A1001G63
		30	(+2, -4 2.5%)	12	444	UX73A	9T10A1002G63
		45	(+2, -4 2.5%)	12	561	UY74A	9T10A1003G63
		75	(+2, -4 2.5%)	12	680	DY75A	9T10A1004G63
		112.5	(+2, -4 2.5%)	12	1030	DY76A	9T10A1005G63
		150	(+2, -4 2.5%)	12	1450	DY77A	9T10A1006G63
		225	(+2, -4 2.5%)	12	1985	DX78A	9T10A1007G63
		300	(+2, -2 2.5%)	12	2900	DX79A	9T10A1008G63

¹See page 10-45 for wiring diagrams.



Dry Type Transformers Noise Isolation – Guard I (Electrostatic Shield)

Copper

Three-Phase DOE 2016 Efficiency

150°C Rise NEMA 2

Input Voltage	Output Voltage	kVA	Taps	Wiring Diagram No. ¹	Approx Net Weight (Lbs)	Frame Size	Product Number
480 Volts Delta	208Y/120 Volts	15	(+2, -4 2.5%)	12	230	UX71C	9T10C1001G03
		30	(+2, -4 2.5%)	12	353	UX72C	9T10C1002G03
		45	(+2, -4 2.5%)	12	480	UX73C	9T10C1003G03
		75	(+2, -4 2.5%)	12	661	UY74C	9T10C1004G03
		112.5	(+2, -4 2.5%)	12	790	DY75C	9T10C1005G03
		150	(+2, -4 2.5%)	12	1085	DY76C	9T10C1006G03
		225	(+2, -4 2.5%)	12	1610	DY77C	9T10C1007G03
		300	(+2, -4 2.5%)	12	1970	DY78C	9T10C1008G03
		500	(+2, -2 2.5%)	12	3720	DX79C	9T10C1009G03

115°C Rise NEMA 2

Input Voltage	Output Voltage	kVA	Taps	Wiring Diagram No. ¹	Approx Net Weight (Lbs)	Frame Size	Product Number
480 Volts Delta	208Y/120 Volts	15	(+2, -4 2.5%)	12	230	UX71C	9T10C1001G33
		30	(+2, -4 2.5%)	12	353	UX72C	9T10C1002G33
		45	(+2, -4 2.5%)	12	480	UX73C	9T10C1003G33
		75	(+2, -4 2.5%)	12	748	UX74C	9T10C1004G33
		112.5	(+2, -4 2.5%)	12	900	DX75C	9T10C1005G33
		150	(+2, -4 2.5%)	12	1240	DX76C	9T10C1006G33
		225	(+2, -4 2.5%)	12	1847	DX77C	9T10C1007G33
		300	(+2, -4 2.5%)	12	2150	DX78C	9T10C1008G33
		500	(+2, -2 2.5%)	12	3720	DX79C	9T10C1009G33

80°C Rise NEMA 2

Input Voltage	Output Voltage	kVA	Taps	Wiring Diagram No. ¹	Approx Net Weight (Lbs)	Frame Size	Product Number
480 Volts Delta	208Y/120 Volts	15	(+2, -4 2.5%)	12	353	UX72C	9T10C1001G63
		30	(+2, -4 2.5%)	12	480	UX73C	9T10C1002G63
		45	(+2, -4 2.5%)	12	661	UY74C	9T10C1003G63
		75	(+2, -4 2.5%)	12	790	DY75C	9T10C1004G63
		112.5	(+2, -4 2.5%)	12	1085	DY76C	9T10C1005G63
		150	(+2, -4 2.5%)	12	1610	DY77C	9T10C1006G63
		225	(+2, -4 2.5%)	12	2150	DX78C	9T10C1007G63
		300	(+2, -4 2.5%)	12	3720	DX79C	9T10C1008G63

¹See page 10-45 for wiring diagrams.



Guard II noise isolation transformers provide common mode noise attenuation plus an enhanced level of transverse mode noise attenuation for increased protection of sensitive electronic equipment.

Key Features

- Grounded copper electrostatic shield between primary and secondary windings
- Noise suppressors and spike/surge suppressors
- 120dB common mode noise rejection
- 60dB transverse mode noise rejection
- Compliance with ANSI and NEMA standards
- Sound levels below NEMA ST-20 limits
- UL Listed
- NEMA 2 enclosure

Applications

- Schools and colleges
- Large computer installations
- Small commercial offices
- Motor installations
- Process controllers
- Hospitals
- X-ray rooms
- Electrical laboratories
- High lightning strike areas



Guard II Transformer

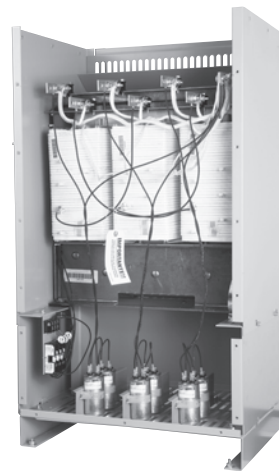

Guard II Transformer, (front panel removed)

Dry Type Transformers Noise Isolation – Guard II Aluminum Three-Phase DOE 2016 Efficiency

Section 10

150°C Rise

Input Voltage	Output Voltage	kVA	Taps	Wiring Diagram No. ¹	Approx Net Weight (Lbs)	Frame Size	Product Number
480 Volts Delta	208Y/120 Volts	15	(+2, -4 2.5%)	12	260	XV371	9T17A1001G03
		30	(+2, -4 2.5%)	12	370	XV372	9T17A1002G03
		45	(+2, -4 2.5%)	12	460	XV373	9T17A1003G03
		75	(+2, -4 2.5%)	12	680	XV374	9T17A1004G03
		112.5	(+2, -4 2.5%)	12	830	XV375	9T17A1005G03

115°C Rise

Input Voltage	Output Voltage	kVA	Taps	Wiring Diagram No. ¹	Approx Net Weight (Lbs)	Frame Size	Product Number
480 Volts Delta	208Y/120 Volts	15	(+2, -4 2.5%)	12	260	XV371	9T17A1001G33
		30	(+2, -4 2.5%)	12	370	XV372	9T17A1002G33
		45	(+2, -4 2.5%)	12	460	XV373	9T17A1003G33
		75	(+2, -4 2.5%)	12	680	XV374	9T17A1004G33

80°C Rise

Input Voltage	Output Voltage	kVA	Taps	Wiring Diagram No. ¹	Approx Net Weight (Lbs)	Frame Size	Product Number
480 Volts Delta	208Y/120 Volts	15	(+2, -4 2.5%)	12	370	XV372	9T17A1001G63
		30	(+2, -4 2.5%)	12	460	XV373	9T17A1002G63
		45	(+2, -4 2.5%)	12	680	XV374	9T17A1003G63
		75	(+2, -4 2.5%)	12	830	XV375	9T17A1004G63

150°C Rise

Input Voltage	Output Voltage	kVA	Taps	Wiring Diagram No. ¹	Approx Net Weight (Lbs)	Frame Size	Product Number
208 Volts Delta	208Y/120 Volts	15	(+2, -4 2.5%)	12	260	XV371	9T17A1451G03
		30	(+2, -4 2.5%)	12	370	XV372	9T17A1452G03
		45	(+2, -4 2.5%)	12	460	XV373	9T17A1453G03
		75	(+2, -4 2.5%)	12	680	XV374	9T17A1454G03
		112.5	(+2, -4 2.5%)	12	830	XV375	9T17A1455G03

115°C Rise

Input Voltage	Output Voltage	kVA	Taps	Wiring Diagram No. ¹	Approx Net Weight (Lbs)	Frame Size	Product Number
208 Volts Delta	208Y/120 Volts	15	(+2, -4 2.5%)	12	260	XV371	9T17A1451G33
		30	(+2, -4 2.5%)	12	370	XV372	9T17A1452G33
		45	(+2, -4 2.5%)	12	460	XV373	9T17A1453G33
		75	(+2, -4 2.5%)	12	680	XV374	9T17A1454G33

80°C Rise

Input Voltage	Output Voltage	kVA	Taps	Wiring Diagram No. ¹	Approx Net Weight (Lbs)	Frame Size	Product Number
208 Volts Delta	208Y/120 Volts	15	(+2, -4 2.5%)	12	370	XV372	9T17A1451G63
		30	(+2, -4 2.5%)	12	460	XV373	9T17A1452G63
		45	(+2, -4 2.5%)	12	680	XV374	9T17A1453G63
		75	(+2, -4 2.5%)	12	830	XV375	9T17A1454G63

¹See page 10-45 for wiring diagrams.



Dry Type Transformers

Noise Isolation – Guard II

Copper

Three-Phase DOE 2016 Efficiency

Section 10

150°C Rise

Input Voltage	Output Voltage	kVA	Taps	Wiring Diagram No. ¹	Approx Net Weight (Lbs)	Frame Size	Product Number
480 Volts Delta	208Y/120 Volts	15	(+2, -4 2.5%)	12	270	XV371	9T17C1001G03
		30	(+2, -4 2.5%)	12	420	XV372	9T17C1002G03
		45	(+2, -4 2.5%)	12	540	XV373	9T17C1003G03
		75	(+2, -4 2.5%)	12	770	XV374	9T17C1004G03
		112.5	(+2, -4 2.5%)	12	1010	XV375	9T17C1005G03

115°C Rise

Input Voltage	Output Voltage	kVA	Taps	Wiring Diagram No. ¹	Approx Net Weight (Lbs)	Frame Size	Product Number
480 Volts Delta	208Y/120 Volts	15	(+2, -4 2.5%)	12	270	XV371	9T17C1001G33
		30	(+2, -4 2.5%)	12	420	XV372	9T17C1002G33
		45	(+2, -4 2.5%)	12	540	XV373	9T17C1003G33
		75	(+2, -4 2.5%)	12	770	XV374	9T17C1004G33
		112.5	(+2, -4 2.5%)	12	1010	XV375	9T17C1005G33

80°C Rise

Input Voltage	Output Voltage	kVA	Taps	Wiring Diagram No. ¹	Approx Net Weight (Lbs)	Frame Size	Product Number
480 Volts Delta	208Y/120 Volts	15	(+2, -4 2.5%)	12	420	XV372	9T17C1001G63
		30	(+2, -4 2.5%)	12	540	XV373	9T17C1002G63
		45	(+2, -4 2.5%)	12	770	XV374	9T17C1003G63
		75	(+2, -4 2.5%)	12	1010	XV375	9T17C1004G63

150°C Rise

Input Voltage	Output Voltage	kVA	Taps	Wiring Diagram No. ¹	Approx Net Weight (Lbs)	Frame Size	Product Number
208 Volts Delta	208Y/120 Volts	15	(+2, -4 2.5%)	12	270	XV371	9T17C1451G03
		30	(+2, -4 2.5%)	12	420	XV372	9T17C1452G03
		45	(+2, -4 2.5%)	12	540	XV373	9T17C1453G03
		75	(+2, -4 2.5%)	12	770	XV374	9T17C1454G03
		112.5	(+2, -4 2.5%)	12	1010	XV375	9T17C1455G03

115°C Rise

Input Voltage	Output Voltage	kVA	Taps	Wiring Diagram No. ¹	Approx Net Weight (Lbs)	Frame Size	Product Number
208 Volts Delta	208Y/120 Volts	15	(+2, -4 2.5%)	12	270	XV371	9T17C1451G33
		30	(+2, -4 2.5%)	12	420	XV372	9T17C1452G33
		45	(+2, -4 2.5%)	12	540	XV373	9T17C1453G33
		75	(+2, -4 2.5%)	12	770	XV374	9T17C1454G33
		112.5	(+2, -4 2.5%)	12	1010	XV375	9T17C1455G33

¹See page 10-45 for wiring diagrams.



Dry Type Transformers Harmonic Mitigating – Guard III

Copper

Three-Phase DOE 2016 Efficiency



150°C Rise NEMA 2, 0° Phase Shift

Input Voltage	Output Voltage	kVA	Approx Net Weight (Lbs)	Frame Size	Product Number
480	208Y/120	15	318	H371C	9T76H9871G03
		30	552	H372C	9T76H9872G03
		45	643	H373C	9T76H9873G03
		75	1053	H374C	9T76H9874G03
		112.5	1980	H375C	9T76H9875G03
		150	2125	H376C	9T76H9876G03
		225		XV377	9T76H9877G03
		300		YF378	9T76H9878G03

150°C Rise NEMA 2, -30° Phase Shift

Input Voltage	Output Voltage	kVA	Approx Net Weight (Lbs)	Frame Size	Product Number
480	208Y/120	15	318	H371C	9T77H9871G03
		30	552	H372C	9T77H9872G03
		45	643	H373C	9T77H9873G03
		75	1053	H374C	9T77H9874G03
		112.5	1980	H375C	9T77H9875G03
		150	2125	H376C	9T77H9876G03
		225		XV377	9T77H9877G03
		300		YF378	9T77H9878G03



Dry Type Transformers Servicenter Mini-Unit Substations Integral Transformer and Distribution Center

Product Description

This easily installed and serviceable unit incorporates a Type QMS transformer (single-phase) or a Type QL transformer (three-phase), a primary main circuit breaker, a secondary main circuit breaker, and a load-center-design breaker panel. Since these components don't have to be installed and interconnected separately, the contractor or user can reduce installation time and costs. Because of the single-unit concept, only one, handy Servicenter needs to be mounted.

Available in single-phase, 5 through 25 kVA, and in three-phase, 15 through 30 kVA, 600 Volt class ratings, the GE Servicenter is a convenient, economical way to meet your industrial and temporary power requirements.

The Transformer—The Servicenter utilizes GE transformer design which has twenty years of field-proven experience behind it and a long track record for assuring consistent, reliable performance. Type QMS transformers employ a 180°C UL Recognized insulation system with a 115°C rise. Type QL transformers employ a 220°C UL Recognized insulation system with a 150°C rise.

The Panel—The panel assembly includes the rugged GE PowerMark Plus™ circuit breaker load center interior, E-frame primary breakers, and E-frame or Q Line secondary breakers. The load center will accept one-, two-, or three-pole (three-phase) common trip circuit breakers and ground fault breakers. All Servicenters come equipped with the properly sized primary main and secondary main circuit breakers installed and prewired. Branch breakers are not included.

Advantages

- Transformer, distribution panel and breakers are all designed, built and assembled by GE
- Saves time and money - pre-assembled, pre-wired unit saves time on the job
- High reliability - assembled and tested in our UL approved factory to assure consistency and quality
- Available GE ground-fault breakers ensure electrical safety around construction sites or wherever water may be present

Key Features

- Keyhole mounting flange facilitates easy mounting
- Indoor and outdoor use
- Front-accessible, hinged or removable panel door is safe and convenient
- Heat barrier under core and coil provides electrical and thermal isolation for wiring compartment
- High-efficiency core construction results in quiet transformer operation and low no-load losses
- Factory installed and wired GE main and secondary main circuit breakers

Application

The single-phase Servicenter can be used wherever 480 Volt power is available and 120 or 240 Volt branch circuits are required. The three-phase Servicenter can be used wherever 240 Volt Δ , 480 Volt Δ or 600 Volt Δ is available and 208 Volt Y/120 Volt circuits are required. The unit can be used in such applications as vending machine areas, construction laboratory test areas, general construction sites where temporary or quickly obtained power is required, or where future expansion of branch circuits is planned.

- Vending or concession areas
- Office buildings
- Assembly lines
- Mining applications
- Parking lots
- Light industrial areas
- Warehouses
- Construction sites

NEC Requirements

The Servicenter conforms with Article 450-3 of the 1993 National Electric Code.



Single-Phase Servicenter, Hinged Door Removed



Three-Phase Servicenter, Closed View



Dry Type Transformers Servicenter Mini-Unit Substations Integral Transformer and Distribution Center

Single-Phase and Three-Phase DOE 2016 Efficiency

Section 10



Single-Phase Servicenter

Single-Phase Indoor/Outdoor 60 Hz

Input Voltage	Output Voltage	kVA	Max. Branch Spaces 1 THQL, 1-pole	Max. Branch Spaces 1 THQL, 2-pole	Max. Branch Spaces 1/2 THQP, 1-pole	Max. Branch Spaces 1/2 THQP, 2-pole	Total 1-pole Spaces	Breaker Rating-Primary Main	Breaker Rating-Secondary Main	Product Number
480 Volts Delta	120/240 Volts	5	6	3	12	4	12	25A	30A	9T21S1050
		7.5	6	3	12	4	12	35A	40A	9T21S1070
		10	8	4	16	6	16	50A	50A	9T21S1100
		15	12	6	24	10	24	60A	70A	9T21S1150
		25	20	10	8	2	24	100A	150A	9T21S1250

Three-Phase² Indoor/Outdoor 60 Hz¹ DOE 2016 Efficiency Aluminum Transformer Windings

Input Voltage	Output Voltage	kVA	Max. Branch Spaces, 1-pole	Max. Branch Spaces 3-pole	Total 1-pole Spaces	Breaker Rating-Primary Main	Breaker Rating-Secondary Main	Product Number
240 Volts Delta	208Y/120 Volts	15	12	4	12	100A	50A	9T17A0001
		22.5	18	6	18	100A	70A	9T17A0002
		30	24	8	24	100A	100A	9T17A0003
480 Volts Delta	208Y/120 Volts	15	12	4	12	40A	50A	9T17A0011
		22.5	18	6	18	70A	70A	9T17A0012
		30	24	8	24	90A	100A	9T17A0013
600 Volts Delta	208Y/120 Volts	15	12	4	12	40A	50A	9T17A0021
		22.5	18	6	18	40A	70A	9T17A0022
		30	24	8	24	40A	100A	9T17A0023

Three-Phase² Indoor/Outdoor 60 Hz¹ DOE 2016 Efficiency Copper Transformer Windings

Input Voltage	Output Voltage	kVA	Max. Branch Spaces, 1-pole	Max. Branch Spaces 3-pole	Total 1-pole Spaces	Breaker Rating-Primary Main	Breaker Rating-Secondary Main	Product Number
240 Volts Delta	208Y/120 Volts	15	12	4	12	100A	50A	9T17C0004
		22.5	18	6	18	100A	70A	9T17C0005
		30	24	8	24	100A	100A	9T17C0006
480 Volts Delta	208Y/120 Volts	15	12	4	12	40A	50A	9T17C0014
		22.5	18	6	18	70A	70A	9T17C0015
		30	24	8	24	90A	100A	9T17C0016
600 Volts Delta	208Y/120 Volts	15	12	4	12	40A	50A	9T17C0024
		22.5	18	6	18	40A	70A	9T17C0025
		30	24	8	24	40A	100A	9T17C0026

¹(3) 5% taps 1 above and 2 below rated primary volts.

²Three-Phase Servicenters may be ordered with a stainless steel enclosure. To order this option, replace the fifth character in the Product Number with the letter "S". For example: 9T17A0001 becomes 9T17S0001; 9T17C0004 becomes 9T17S0004.



Dry Type Transformers Servicenter Mini-Unit Substations Integral Transformer and Distribution Center

Outlines, Dimensions and Wiring Diagrams

Single-Phase

kVA	Product Number	Approx. Net Weight (Lbs.)	"A" Height (in.)	"B" Width (in.)	"C" Depth (in.)	Frame Size
5	9T21S1050	103	32.5	10.75	11.12	16350
7.5	9T21S1070	147	32.5	10.75	11.12	16600
10	9T21S1100	198	35	12.62	12.62	19400
15	9T21S1150	220	35	12.62	12.62	19500
25	9T21S1250	388	44.75	16.75	16	50500

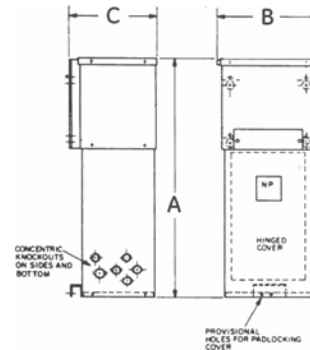

Dimensions Single-Phase

Three-Phase DOE 2016 Efficiency Aluminum

kVA	Product Number	Approx. Net Weight (Lbs.)	"B" Height (in.)	"A" Width (in.)	Depth (in.)	Frame Size
15	9T17A0001	280	27.3	27.4	16.9	UX71A
22.5	9T17A0002	450	32.2	34.5	24	UX72A
30	9T17A0003	450	32.2	34.5	24	UX72A
15	9T17A0011	280	27.3	27.4	16.9	UX71A
22.5	9T17A0012	450	32.2	34.5	24	UX72A
30	9T17A0013	450	32.2	34.5	24	UX72A
15	9T17A0021	280	27.3	27.4	16.9	UX71A
22.5	9T17A0022	450	32.2	34.5	24	UX72A
30	9T17A0023	450	32.2	34.5	24	UX72A

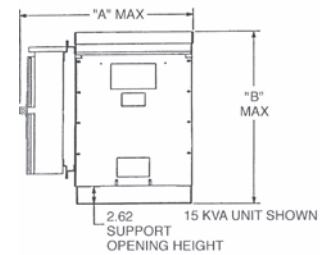

Dimensions Three-Phase

Three-Phase DOE 2016 Efficiency Copper

kVA	Product Number	Approx Net Weight (Lbs)	"A" Height (in.)	"B" Height (in.)	"C" Height (in.)	Frame Size
15	9T17C0004	290	27.3	27.4	16.9	UX71C
22.5	9T17C0005	460	32.2	34.5	24	UX72C
30	9T17C0006	460	32.2	34.5	24	UX72C
15	9T17C0014	290	27.3	27.4	16.9	UX71C
22.5	9T17C0015	460	32.2	34.5	24	UX72C
30	9T17C0016	460	32.2	34.5	24	UX72C
15	9T17C0024	290	27.3	27.4	16.9	UX71C
22.5	9T17C0025	460	32.2	34.5	24	UX72C
30	9T17C0026	460	32.2	34.5	24	UX72C

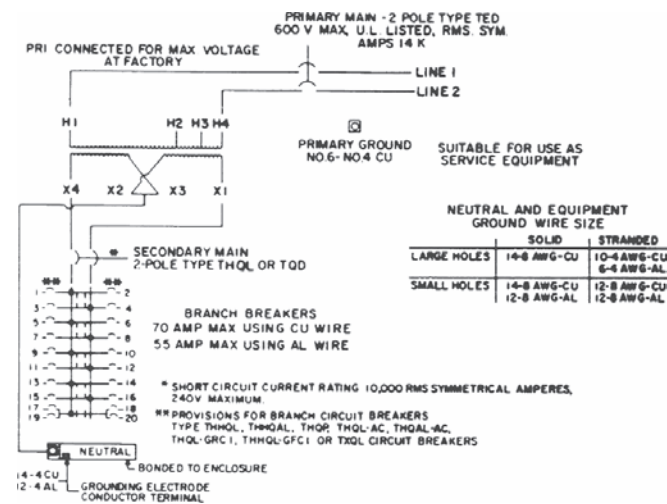

Typical Wiring Diagram Single-Phase

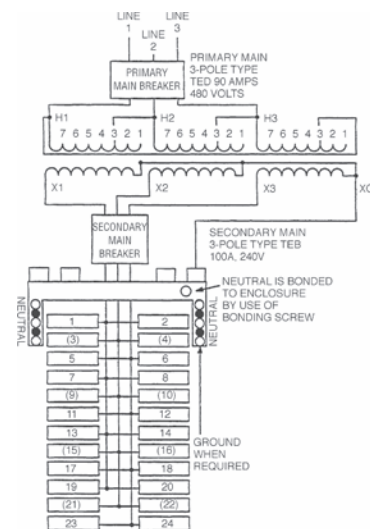

Typical Wiring Diagram Three-Phase¹

¹For 22.5 and 15 kVA three-phase Servicers, secondary main breaker is a backed plug-in type with positive retainers.



Dry Type Transformers

Totally Enclosed, Nonventilated

TENV

15-75kVA, Three-Phase, NEMA TP-1 Efficiency

Totally enclosed nonventilated (TENV) transformers are an excellent choice for applications where dry-type transformer benefits are desired but the standard enclosure openings are unacceptable because of adverse atmospheric conditions. TENV transformers are recommended where dust, dirt or lint may be present or where transformers are subject to sprays or controlled wash-down conditions. They are UL Listed through 75kVA for indoor or protected outdoor applications.

Advantages

- Dry-type transformer is housed in an enclosed NEMA 3R non-ventilated compartment
- Convenient wiring compartment is located beneath the transformer and has removable front and rear covers
- Copper bus bars are located at the front of the wiring compartment and are clearly labeled
- All electrical connections between the transformer and bus bars are factory wired
- Quiet performance – meets NEMA ST-20
- No-weld coil termination design – an industry first
- Comprehensive factory testing assures quality

Features

- Quiet design - unique core and coil design makes GE TENV transformers among the quietest available
- Core and coil assembly mounted on rubber isolation pads to reduce noise
- Bolted coil terminations are more reliable than welded terminations, and they eliminate weld failures and problems associated with welding and weld splatter
- 100% factory tested for shorts and coil integrity, current and loss, voltage, impedance and noise
- Qualified to the seismic requirements of IEEE-693-2005 and IBC-2012/CBC-2013
- Copper ground strap
- Copper or aluminum windings available
- Available in 150°C, 115°C, and 80°C rise models
- Indoor or outdoor use

Applications

- Textile
- Automotive
- Foundry
- Paper mills
- Wash-down areas



TENV Transformer



Dry Type Transformers Totally Enclosed, Nonventilated TENV

Section 10

Three-Phase DOE 2016 Efficiency

Aluminum 150°C Rise

Input Voltage	Output Voltage	kVA	Taps	Net Weight (Lbs.)	Frame Size	Product Number
480	208Y/120	15	(+2,-4 2.5%)	370	XV372	9T85B3871
480	208Y/120	30	(+2,-4 2.5%)	450	XV373	9T85B3872
480	208Y/120	45	(+2,-4 2.5%)	670	XV374	9T85B3873
480	208Y/120	75	(+2,-4 2.5%)	815	XV375	9T85B3874

Aluminum 115°C Rise

Input Voltage	Output Voltage	kVA	Taps	Net Weight (Lbs.)	Frame Size	Product Number
480	208Y/120	15	(+2,-4 2.5%)	370	XV372	9T85B3871G15
480	208Y/120	30	(+2,-4 2.5%)	450	XV373	9T85B3872G15
480	208Y/120	45	(+2,-4 2.5%)	670	XV374	9T85B3873G15
480	208Y/120	75	(+2,-4 2.5%)	815	XV375	9T85B3874G15

Aluminum 80°C Rise

Input Voltage	Output Voltage	kVA	Taps	Net Weight (Lbs.)	Frame Size	Product Number
480	208Y/120	30	(+2,-4 2.5%)	670	XV374	9T85B3872G80
480	208Y/120	45	(+2,-4 2.5%)	670	XV374	9T85B3873G80

Copper 150°C Rise

Input Voltage	Output Voltage	kVA	Taps	Net Weight (Lbs.)	Frame Size	Product Number
480	208Y/120	15	(+2,-4 2.5%)	410	XV372	9T85C9871
480	208Y/120	30	(+2,-4 2.5%)	525	XV373	9T85C9872
480	208Y/120	45	(+2,-4 2.5%)	760	XV374	9T85C9873
480	208Y/120	75	(+2,-4 2.5%)	1000	XV375	9T85C9874

Copper 115°C Rise

Input Voltage	Output Voltage	kVA	Taps	Net Weight (Lbs.)	Frame Size	Product Number
480	208Y/120	15	(+2,-4 2.5%)	410	XV372	9T85C9871G15
480	208Y/120	30	(+2,-4 2.5%)	525	XV373	9T85C9872G15
480	208Y/120	45	(+2,-4 2.5%)	760	XV374	9T85C9873G15
480	208Y/120	75	(+2,-4 2.5%)	1000	XV375	9T85C9874G15

Copper 80°C Rise

Input Voltage	Output Voltage	kVA	Taps	Net Weight (Lbs.)	Frame Size	Product Number
480	208Y/120	15	(+2,-4 2.5%)	410	XV372	9T85C9871G80
480	208Y/120	30	(+2,-4 2.5%)	760	XV374	9T85C9872G80
480	208Y/120	45	(+2,-4 2.5%)	760	XV374	9T85C9873G80



Dry Type Transformers Midtapped Three-Phase DOE 2016 Efficiency

Product Description

GE Type QL midtapped transformer enables the user to transform three-phase power from 480 Volts primary to 240 Volts secondary and have 120 Volt, reduced capacity tap (RCT) single-phase capability as well. This is because a single-phase midtap is brought out of one coil of the unit's three-phase secondary winding. These transformers are UL listed, File E-79145.

Application

The Type QL midtapped design can be used wherever there is 480 Volt, three-phase supply available and the load is primarily 240 Volt three-phase with a nominal amount of 120 Volt, single-phase power required. Normally, in this instance, a small single-phase as well as a three-phase transformer would be required to provide the necessary transformation.

Caution: When utilizing the 120 Volt midtap for single-phase applications, the single-phase load should not exceed 5 percent of the three-phase kVA rating. The three-phase kVA load must be reduced by the same percentage as that added by the single-phase load. Additional loading beyond 5 percent may cause the transformer to overheat and fail. If the single-phase load is in excess of 5 percent, it is recommended that a separate single-phase unit be used to handle the load.



Type QL Midtapped Transformer

Aluminum

150°C Rise 60Hz

Input Voltage	Output Voltage	kVA	Taps	Net Weight (Lbs.)	Frame Size	Product Number
480	240/120	15	(+2,-4 2.5%)	231	UX71A	9T10A1181
480	240/120	30	(+2,-4 2.5%)	330	UX72A	9T10A1182
480	240/120	45	(+2,-4 2.5%)	444	UX73A	9T10A1183
480	240/120	75	(+2,-4 2.5%)	561	UY74A	9T10A1184
480	240/120	112.5	(+2,-4 2.5%)	830	DX75A	9T10A1185
480	240/120	150	(+2,-4 2.5%)	1030	DY76A	9T10A1186
480	240/120	225	(+2,-4 2.5%)	1450	DY77A	9T10A1187
480	240/120	300	(+2,-4 2.5%)	1670	DY78A	9T10A1188
480	240/120	500	(+2,-2 2.5%)	2900	DX79A	9T10A1189

115°C Rise 60Hz

Input Voltage	Output Voltage	kVA	Taps	Net Weight (Lbs.)	Frame Size	Product Number
480	240/120	15	(+2,-4 2.5%)	231	UX71A	9T10A1181G31
480	240/120	30	(+2,-4 2.5%)	330	UX72A	9T10A1182G31
480	240/120	45	(+2,-4 2.5%)	444	UX73A	9T10A1183G31
480	240/120	75	(+2,-4 2.5%)	603	UX74A	9T10A1184G31
480	240/120	112.5	(+2,-4 2.5%)	830	DX75A	9T10A1185G31
480	240/120	150	(+2,-4 2.5%)	1250	DX76A	9T10A1186G31
480	240/120	225	(+2,-4 2.5%)	1670	DX77A	9T10A1187G31
480	240/120	300	(+2,-4 2.5%)	1985	DX78A	9T10A1188G31
480	240/120	500	(+2,-2 2.5%)	2900	DX79A	9T10A1189G31

80°C Rise 60Hz

Input Voltage	Output Voltage	kVA	Taps	Net Weight (Lbs.)	Frame Size	Product Number
480	240/120	15	(+2,-4 2.5%)	330	UX72A	9T10A1181G61
480	240/120	30	(+2,-4 2.5%)	444	UX73A	9T10A1182G61
480	240/120	45	(+2,-4 2.5%)	561	UY74A	9T10A1183G61
480	240/120	75	(+2,-4 2.5%)	680	DY75A	9T10A1184G61
480	240/120	150	(+2,-4 2.5%)	1450	DY77A	9T10A1186G61
480	240/120	225	(+2,-4 2.5%)	1985	DX78A	9T10A1187G61



Dry Type Transformers Midtapped Aluminum

Section 10

Three-Phase DOE 2016 Efficiency

150°C Rise 60Hz Low Noise (-3dB)

Input Voltage	Output Voltage	kVA	Taps	Net Weight (Lbs.)	Frame Size	Product Number
480	240/120	15	(+2,-4 2.5%)	231	UX71A	9T10A1181G02
480	240/120	30	(+2,-4 2.5%)	330	UX72A	9T10A1182G02
480	240/120	45	(+2,-4 2.5%)	444	UX73A	9T10A1183G02
480	240/120	75	(+2,-4 2.5%)	561	UY74A	9T10A1184G02
480	240/120	112.5	(+2,-4 2.5%)	680	DX75A	9T10A1185G02
480	240/120	150	(+2,-4 2.5%)	1030	DY76A	9T10A1186G02
480	240/120	225	(+2,-4 2.5%)	1450	DY77A	9T10A1187G02
480	240/120	300	(+2,-4 2.5%)	1670	DY78A	9T10A1188G02
480	240/120	500	(+2,-2 2.5%)	2900	DX79A	9T10A1189G02

115°C Rise 60Hz Low Noise (-3dB)

Input Voltage	Output Voltage	kVA	Taps	Net Weight (Lbs.)	Frame Size	Product Number
480	240/120	15	(+2,-4 2.5%)	231	UX71A	9T10A1181G32
480	240/120	30	(+2,-4 2.5%)	330	UX72A	9T10A1182G32
480	240/120	45	(+2,-4 2.5%)	444	UX73A	9T10A1183G32
480	240/120	75	(+2,-4 2.5%)	603	UX74A	9T10A1184G32
480	240/120	112.5	(+2,-4 2.5%)	830	DX75A	9T10A1185G32
480	240/120	150	(+2,-4 2.5%)	1250	DX76A	9T10A1186G32
480	240/120	225	(+2,-4 2.5%)	1670	DX77A	9T10A1187G32
480	240/120	300	(+2,-4 2.5%)	1985	DX78A	9T10A1188G32
480	240/120	500	(+2,-2 2.5%)	2900	DX79A	9T10A1189G32



Dry Type Transformers Midtapped

Copper

Three-Phase DOE 2016 Efficiency

150°C Rise 60Hz

Input Voltage	Output Voltage	kVA	Taps	Net Weight (Lbs.)	Frame Size	Product Number
480	240/120	15	(+2,-4 2.5%)	230	UX71C	9T10C1181
480	240/120	30	(+2,-4 2.5%)	353	UX72C	9T10C1182
480	240/120	45	(+2,-4 2.5%)	480	UX73C	9T10C1183
480	240/120	75	(+2,-4 2.5%)	661	UY74C	9T10C1184
480	240/120	112.5	(+2,-4 2.5%)	790	DY75C	9T10C1185
480	240/120	150	(+2,-4 2.5%)	1085	DY76C	9T10C1186
480	240/120	225	(+2,-4 2.5%)	1610	DY77C	9T10C1187
480	240/120	300	(+2,-4 2.5%)	1970	DY78C	9T10C1188
480	240/120	500	(+2,-2 2.5%)	3720	DX79C	9T10C1189

115°C Rise 60Hz

Input Voltage	Output Voltage	kVA	Taps	Net Weight (Lbs.)	Frame Size	Product Number
480	240/120	15	(+2,-4 2.5%)	230	UX71C	9T10C1181G31
480	240/120	30	(+2,-4 2.5%)	353	UX72C	9T10C1182G31
480	240/120	45	(+2,-4 2.5%)	480	UX73C	9T10C1183G31
480	240/120	75	(+2,-4 2.5%)	748	UX74C	9T10C1184G31
480	240/120	112.5	(+2,-4 2.5%)	900	DX75C	9T10C1185G31
480	240/120	150	(+2,-4 2.5%)	1240	DX76C	9T10C1186G31
480	240/120	225	(+2,-4 2.5%)	1847	DX77C	9T10C1187G31
480	240/120	300	(+2,-4 2.5%)	2150	DX78C	9T10C1188G31
480	240/120	500	(+2,-2 2.5%)	3720	DX79C	9T10C1189G31

80°C Rise 60Hz

Input Voltage	Output Voltage	kVA	Taps	Net Weight (Lbs.)	Frame Size	Product Number
480	240/120	15	(+2,-4 2.5%)	353	UX72C	9T10C1181G61
480	240/120	30	(+2,-4 2.5%)	480	UX73C	9T10C1182G61
480	240/120	45	(+2,-4 2.5%)	661	UY74C	9T10C1183G61
480	240/120	75	(+2,-4 2.5%)	790	DY75C	9T10C1184G61
480	240/120	112.5	(+2,-4 2.5%)	1085	DY76C	9T10C1185G61
480	240/120	150	(+2,-4 2.5%)	1610	DY77C	9T10C1186G61
480	240/120	225	(+2,-4 2.5%)	2150	DX78C	9T10C1187G61
480	240/120	300	(+2,-2 2.5%)	3720	DX79C	9T10C1188G61

150°C Rise 60Hz Low Noise (-3dB)

Input Voltage	Output Voltage	kVA	Taps	Net Weight (Lbs.)	Frame Size	Product Number
480	240/120	15	(+2,-4 2.5%)	230	UX71C	9T10C1181G02
480	240/120	30	(+2,-4 2.5%)	353	UX72C	9T10C1182G02
480	240/120	45	(+2,-4 2.5%)	480	UX73C	9T10C1183G02
480	240/120	75	(+2,-4 2.5%)	661	UY74C	9T10C1184G02
480	240/120	112.5	(+2,-4 2.5%)	790	DY75C	9T10C1185G02
480	240/120	150	(+2,-4 2.5%)	1085	DY76C	9T10C1186G02
480	240/120	225	(+2,-4 2.5%)	1610	DY77C	9T10C1187G02
480	240/120	300	(+2,-4 2.5%)	1970	DY78C	9T10C1188G02
480	240/120	500	(+2,-2 2.5%)	3720	DX79C	9T10C1189G02

115°C Rise 60Hz Low Noise (-3dB)

Input Voltage	Output Voltage	kVA	Taps	Net Weight (Lbs.)	Frame Size	Product Number
480	240/120	15	(+2,-4 2.5%)	230	UX71C	9T10C1181G32
480	240/120	30	(+2,-4 2.5%)	353	UX72C	9T10C1182G32
480	240/120	45	(+2,-4 2.5%)	480	UX73C	9T10C1183G32
480	240/120	75	(+2,-4 2.5%)	748	UX74C	9T10C1184G32
480	240/120	112.5	(+2,-4 2.5%)	900	DX75C	9T10C1185G32
480	240/120	150	(+2,-4 2.5%)	1240	DX76C	9T10C1186G32
480	240/120	225	(+2,-4 2.5%)	1847	DX77C	9T10C1187G32
480	240/120	300	(+2,-4 2.5%)	2150	DX78C	9T10C1188G32
480	240/120	500	(+2,-2 2.5%)	3720	DX79C	9T10C1189G32

80°C Rise 60Hz Low Noise (-3dB)

Input Voltage	Output Voltage	kVA	Taps	Net Weight (Lbs.)	Frame Size	Product Number
480	240/120	15	(+2,-4 2.5%)	353	UX72C	9T10C1181G62
480	240/120	30	(+2,-4 2.5%)	480	UX73C	9T10C1182G62
480	240/120	45	(+2,-4 2.5%)	661	UY74C	9T10C1183G62
480	240/120	75	(+2,-4 2.5%)	790	DY75C	9T10C1184G62
480	240/120	112.5	(+2,-4 2.5%)	1085	DY76C	9T10C1185G62
480	240/120	150	(+2,-4 2.5%)	1610	DY77C	9T10C1186G62
480	240/120	225	(+2,-4 2.5%)	2150	DX78C	9T10C1187G62
480	240/120	300	(+2,-2 2.5%)	3720	DX79C	9T10C1188G62



Dry Type Transformers

Drive Isolation

Aluminum

Three-Phase

Application

The use of SCR control circuitry with adjustable-speed drives has resulted in a need for a line of isolation transformers specifically designed to meet the demanding requirements of SCR drives. Symmetrically placed taps and added coil bracing minimize mechanical forces caused by the often severe SCR drive duty cycles. These features also help protect the transformer from the regenerative duty and more frequent short-circuits associated

with SCR drives. Isolation transformers also reduce line-pollution feedback resulting from SCR firing circuits. The GE delta-wye designs meet the NEC requirements for grounded secondary neutrals that isolate primary distribution systems. kVA ratings of the DIT line cover most dc motor requirements from 3 to 1000 hp. Enclosed drive isolation transformers are UL listed.

15 - 220 kVA Indoor Type QL UL Listed

Input Voltage	Output Voltage	kVA	Frequency (Hz)	Wiring Diagram No. ¹	Weight (Lbs)	Frame Size	Product Number
230 Volts Delta	230Y/133 Volts	15	60Hz	16	240	XV371	9T83B4000G29
230 Volts Delta	230Y/133 Volts	20	60Hz	16	334	XV372	9T83B4001G29
230 Volts Delta	230Y/133 Volts	27	60Hz	16	334	XV372	9T83B4002G29
230 Volts Delta	230Y/133 Volts	34	60Hz	16	334	XV372	9T83B4003G29
230 Volts Delta	230Y/133 Volts	40	60Hz	16	415	XV373	9T83B4004G29
230 Volts Delta	230Y/133 Volts	51	60Hz	16	415	XV373	9T83B4005G29
230 Volts Delta	230Y/133 Volts	63	60Hz	16	620	XV374	9T83B4006G29
230 Volts Delta	230Y/133 Volts	75	60Hz	16	620	XV374	9T83B4007G29
230 Volts Delta	230Y/133 Volts	93	60Hz	16	765	XV375	9T83B4008G29
230 Volts Delta	230Y/133 Volts	118	60Hz	16	1070	XV376	9T83B4009G29
230 Volts Delta	230Y/133 Volts	145	60Hz	16	1070	XV376	9T83B4010G29
230 Volts Delta	230Y/133 Volts	175	60Hz	16	1590	XV377	9T83B4011G29
230 Volts Delta	230Y/133 Volts	220	60Hz	16	1590	XV377	9T83B4012G29
230 Volts Delta	460Y/266 Volts	15	60Hz	16	240	XV371	9T83B4000G28
230 Volts Delta	460Y/266 Volts	20	60Hz	16	334	XV372	9T83B4001G28
230 Volts Delta	460Y/266 Volts	27	60Hz	16	334	XV372	9T83B4002G28
230 Volts Delta	460Y/266 Volts	34	60Hz	16	334	XV372	9T83B4003G28
230 Volts Delta	460Y/266 Volts	40	60Hz	16	415	XV373	9T83B4004G28
230 Volts Delta	460Y/266 Volts	51	60Hz	16	415	XV373	9T83B4005G28
230 Volts Delta	460Y/266 Volts	63	60Hz	16	620	XV374	9T83B4006G28
230 Volts Delta	460Y/266 Volts	75	60Hz	16	620	XV374	9T83B4007G28
230 Volts Delta	460Y/266 Volts	93	60Hz	16	765	XV375	9T83B4008G28
230 Volts Delta	460Y/266 Volts	118	60Hz	16	1070	XV376	9T83B4009G28
230 Volts Delta	460Y/266 Volts	145	60Hz	16	1070	XV376	9T83B4010G28
230 Volts Delta	460Y/266 Volts	175	60Hz	16	1590	XV377	9T83B4011G28
230 Volts Delta	460Y/266 Volts	220	60Hz	16	1590	XV377	9T83B4012G28

¹See page 10-45 for wiring diagrams.



Dry Type Transformers Drive Isolation Aluminum Three-Phase

15 - 220 kVA Indoor Type QL UL Listed (continued)

Input Voltage	Output Voltage	kVA	Frequency (Hz)	Wiring Diagram No. ¹	Weight (Lbs)	Frame Size	Product Number
460 Volts Delta	230Y/133	15	60 Hz	16	240	XV371	9T83B4000G23
460 Volts Delta	230Y/133	20	60 Hz	16	334	XV372	9T83B4001G23
460 Volts Delta	230Y/133	27	60 Hz	16	334	XV372	9T83B4002G23
460 Volts Delta	230Y/133	34	60 Hz	16	334	XV372	9T83B4003G23
460 Volts Delta	230Y/133	40	60 Hz	16	415	XV373	9T83B4004G23
460 Volts Delta	230Y/133	51	60 Hz	16	415	XV373	9T83B4005G23
460 Volts Delta	230Y/133	63	60 Hz	16	620	XV374	9T83B4006G23
460 Volts Delta	230Y/133	75	60 Hz	16	620	XV374	9T83B4007G23
460 Volts Delta	230Y/133	93	60 Hz	16	765	XV375	9T83B4008G23
460 Volts Delta	230Y/133	118	60 Hz	16	1070	XV376	9T83B4009G23
460 Volts Delta	230Y/133	145	60 Hz	16	1070	XV376	9T83B4010G23
460 Volts Delta	230Y/133	175	60 Hz	16	1590	XV377	9T83B4011G23
460 Volts Delta	230Y/133	220	60 Hz	16	1590	XV377	9T83B4012G23
460 Volts Delta	460Y/266	15	60 Hz	16	240	XV371	9T83B4000G22
460 Volts Delta	460Y/266	20	60 Hz	16	334	XV372	9T83B4001G22
460 Volts Delta	460Y/266	27	60 Hz	16	334	XV372	9T83B4002G22
460 Volts Delta	460Y/266	34	60 Hz	16	334	XV372	9T83B4003G22
460 Volts Delta	460Y/266	40	60 Hz	16	415	XV373	9T83B4004G22
460 Volts Delta	460Y/266	51	60 Hz	16	415	XV373	9T83B4005G22
460 Volts Delta	460Y/266	63	60 Hz	16	620	XV374	9T83B4006G22
460 Volts Delta	460Y/266	75	60 Hz	16	620	XV374	9T83B4007G22
460 Volts Delta	460Y/266	93	60 Hz	16	765	XV375	9T83B4008G22
460 Volts Delta	460Y/266	118	60 Hz	16	1070	XV376	9T83B4009G22
460 Volts Delta	460Y/266	145	60 Hz	16	1070	XV376	9T83B4010G22
460 Volts Delta	460Y/266	175	60 Hz	16	1590	XV377	9T83B4011G22
460 Volts Delta	460Y/266	220	60 Hz	16	1590	XV377	9T83B4012G22
575 Volts Delta	230Y/133	15	60 Hz	16	240	XV371	9T83B4000G27
575 Volts Delta	230Y/133	20	60 Hz	16	334	XV372	9T83B4001G27
575 Volts Delta	230Y/133	27	60 Hz	16	334	XV372	9T83B4002G27
575 Volts Delta	230Y/133	34	60 Hz	16	334	XV372	9T83B4003G27
575 Volts Delta	230Y/133	40	60 Hz	16	415	XV373	9T83B4004G27
575 Volts Delta	230Y/133	51	60 Hz	16	415	XV373	9T83B4005G27
575 Volts Delta	230Y/133	63	60 Hz	16	620	XV374	9T83B4006G27
575 Volts Delta	230Y/133	75	60 Hz	16	620	XV374	9T83B4007G27
575 Volts Delta	230Y/133	93	60 Hz	16	765	XV375	9T83B4008G27
575 Volts Delta	230Y/133	118	60 Hz	16	1070	XV376	9T83B4009G27
575 Volts Delta	230Y/133	145	60 Hz	16	1070	XV376	9T83B4010G27
575 Volts Delta	230Y/133	175	60 Hz	16	1590	XV377	9T83B4011G27
575 Volts Delta	230Y/133	220	60 Hz	16	1590	XV377	9T83B4012G27
575 Volts Delta	460Y/266	15	60 Hz	16	240	XV371	9T83B4000G26
575 Volts Delta	460Y/266	20	60 Hz	16	334	XV372	9T83B4001G26
575 Volts Delta	460Y/266	27	60 Hz	16	334	XV372	9T83B4002G26
575 Volts Delta	460Y/266	34	60 Hz	16	334	XV372	9T83B4003G26
575 Volts Delta	460Y/266	40	60 Hz	16	415	XV373	9T83B4004G26
575 Volts Delta	460Y/266	51	60 Hz	16	415	XV373	9T83B4005G26
575 Volts Delta	460Y/266	63	60 Hz	16	620	XV374	9T83B4006G26
575 Volts Delta	460Y/266	75	60 Hz	16	620	XV374	9T83B4007G26
575 Volts Delta	460Y/266	93	60 Hz	16	765	XV375	9T83B4008G26
575 Volts Delta	460Y/266	118	60 Hz	16	1070	XV376	9T83B4009G26
575 Volts Delta	460Y/266	145	60 Hz	16	1070	XV376	9T83B4010G26
575 Volts Delta	460Y/266	175	60 Hz	16	1590	XV377	9T83B4011G26
575 Volts Delta	460Y/266	220	60 Hz	16	1590	XV377	9T83B4012G26

¹See page 10-45 for wiring diagrams.

NOTE: Full capacity symmetrical taps (1) +5% and (1) -5%, in primary windings for 230 and 460 Y thru 550 kVA; (1) +6.2% and (1) -6.2% at 750 kVA; (1) +6.4% and (1) -6.4% at 1000 kVA. With 575 V primary, symmetrical 5% taps apply thru 750 kVA; at 1000 kVA, (1) +5.1% and (1) -5.1%. For ratings less than 15 kV contact GE Energy Sales Office.

Conversion Chart

Decimal	Fraction
.13	1/8
.38	3/8
.63	5/8
.88	7/8



Dry Type Transformers Accessories and Lugs Single-Phase and Three-Phase

Section 10

Wall Mount Bracket

Frame Size	Product Number
UX71A	9T18Y1071G07
UX71C	9T18Y1071G07
UX72A	9T18Y1071G07
UX72C	9T18Y1071G07
UX73A	9T18Y1071G07
UX73C	9T18Y1071G07
UX74A	9T18Y1074G07
UX74C	9T18Y1074G07
UY74A	9T18Y1074G07
UY74C	9T18Y1074G07
DX75C	9T18Y1074G07
DY75A	9T18Y1074G07
DY75C	9T18Y1074G07
YF171	9T18Y5042
YF172	9T18Y5043
YF174	9T18Y5043
YF175	Not available
YF176	Not available
YF177	Not available

Bottom Pan

Frame Size	Product Number
DX76A	9T18Y1077G09
DX77A	9T18Y1077G09
DX77C	9T18Y1077G09
DY77A	9T18Y1077G09
DY77C	9T18Y1077G09
DX78A	9T18Y1078G09
DX78C	9T18Y1078G09
DY78A	9T18Y1078G09
DY78C	9T18Y1078G09
DX79A	9T18Y1079G09
DX79C	9T18Y1079G09
YF175	9T18Y4504G77
YF176	9T18Y4504G79
YF177	9T18Y4504G79

316 Stainless Steel Rain Shield Kit

Frame Size	Product Number
UX71A	9T18Y1171G06
UX71C	9T18Y1171G06
UX72A	9T18Y1172G06
UX73A	9T18Y1172G06
UX72C	9T18Y1172G06
UX73C	9T18Y1172G06
UY74A	9T18Y1174G06
UX74A	9T18Y1174G06
UY74C	9T18Y1174G06
UX74C	9T18Y1174G06
DY75A	9T18Y1174G06
DY75C	9T18Y1174G06
DX75C	9T18Y1174G06
DY76A	9T18Y1176G06
DY76C	9T18Y1176G06
DX75A	9T18Y1176G06
DX76C	9T18Y1176G06

Ground Bar Kit

Frame Size	Product Number
UX71A	9T18Y1071G11
UX71C	9T18Y1071G11
UX72A	9T18Y1071G11
UX73A	9T18Y1071G11
UX72C	9T18Y1071G11
UX73C	9T18Y1071G11
UY74A	9T18Y1074G11
UX74A	9T18Y1074G11
UY74C	9T18Y1074G11
UX74C	9T18Y1074G11
DY75A	9T18Y1074G11
DY76A	9T18Y1074G11
DY75C	9T18Y1074G11
DY76C	9T18Y1074G11
DX75A	9T18Y1074G11
DX75C	9T18Y1074G11
DX76C	9T18Y1074G11

Rain Shield Kit

Frame Size	Product Number
UX71A	9T18Y1071G06
UX71C	9T18Y1071G06
UX72A	9T18Y1072G06
UX72C	9T18Y1072G06
UX73A	9T18Y1072G06
UX73C	9T18Y1072G06
UY74A	9T18Y1074G06
UX74A	9T18Y1074G06
UY74C	9T18Y1074G06
UX74C	9T18Y1074G06
DY75A	9T18Y1074G06
DY75C	9T18Y1074G06
DX75A	9T18Y1076G06
DX75C	9T18Y1074G06
DY76A	9T18Y1076G06
DY76C	9T18Y1076G06
DX76A	9T18Y1077G06
DX76C	9T18Y1076G06
DX77A	9T18Y1077G06
DX77C	9T18Y1077G06
DY77A	9T18Y1077G06
DY77C	9T18Y1077G06
DY78C	9T18Y1077G06
DY78A	9T18Y1077G06
DX78A	9T18Y1077G06
DX78C	9T18Y1077G06
DX79A	9T18Y1079G06
DX79C	9T18Y1079G06
YF171	9T18Y4317G05
YF172	9T18Y4317G06
YF174	9T18Y4317G06
YF175	9V18Y4322G77
YF176	9T18Y4322G79
YF177	9T18Y4322G79

Lug Kits for QL Transformers

Frame Size	Product Number
UX71A	9T18Y1071G10
UX71C	9T18Y1071G10
UX72A	9T18Y1072G10
UX73A	9T18Y1072G10
UX72C	9T18Y1072G10
UX73C	9T18Y1072G10
UY74A	9T18Y1074G10
UX74A	9T18Y1074G10
UY74C	9T18Y1074G10
UX74C	9T18Y1074G10
DY75A	9T18Y1075G10
DY75C	9T18Y1075G10
DX75C	9T18Y1075G10
DY76A	9T18Y1076G10
DY76C	9T18Y1076G10
DX75A	9T18Y1076G10
DX76C	9T18Y1076G10
DY77A	9T18Y1077G10
DY77C	9T18Y1077G10
DX76A	9T18Y1077G10
DX77A	9T18Y1077G10
DX77C	9T18Y1077G10
DY78A	9T18Y1078G10
DY78C	9T18Y1078G10
DX78A	9T18Y1078G10
DX78C	9T18Y1078G10
DX79A	9T18Y1079G10
DX79C	9T18Y1079G10
YF171	9T18Y7240G02
YF172	9T18Y7241G03
YF174	9T18Y7240G03
YF175	9T18Y7242G07
YF176	9T18Y7242G05
YF177	9T18Y7242G05



Dry Type Transformers Accessories and Lugs Single-Phase and Three-Phase

Section 10

Lug Kit Information for QL Transformers

Frame Size	Typical Transformer Size	Primary Bus Bar Holes (Qty/Size)	Secondary Bus Bar Holes (Qty/Size)	Kit Number	Specified Lug Kit					
					Lug Size No.1			Lug Size No.2		
					Qty	Conductor Size	Stud Hole Size	Qty	Conductor Size	Stud Hole Size
YF171	1 ph - 15/25 kVA (2670/2671)	(2) .406 dia	(2) .406 dia	9T18Y7240G02 ¹	8	6 AWG to 250 MCM	5/16	N/A	N/A	N/A
YF171	1 ph - 37.5 kVA (2672)	(2) .563 dia	(2) .563 dia							
YF172	1 ph - 50 kVA (2673)	(2) .563 dia	(2) .563 dia	9T18Y7241G03	4	6 AWG to 250 MCM	5/16	4	6 AWG to 350 MCM	3/8
YF174	1 ph - 75 kVA (2674)	(2) .563 dia	(2) .563 dia	9T18Y7240G03	12	6 AWG to 250 MCM	5/16	N/A	N/A	N/A
YF175	1 ph - 100 kVA (2675)	(2) .563 dia	(2) .563 dia	9T18Y7242G07	12	6 AWG to 350 MCM	3/8	N/A	N/A	N/A
YF176	1 ph - 167 kVA (2676)	(4) .563 dia	(4) .563 dia	9T18Y7242G05	8	6 AWG to 350 MCM	3/8	12	4 AWG to 500 MCM	3/8
UX71A/UX71C	3 ph - 15 kVA (001)	(2) .406 dia	(2) .406 dia	9T18Y1071G10 ¹	7	14 AWG to 1/0 AWG	1/4	N/A	N/A	N/A
UX72A/UX72C/ UX73A/UX73C	3 ph - 30/45 kVA (002/003)	(2) .406 dia	(2) .406 dia	9T18Y1072G10 ¹	7	6 AWG to 250 MCM	5/16	N/A	N/A	N/A
UX74A/UX74C/ UY74A/UY74C	3 ph - 75 kVA (004)	(2) .406 dia	(2) .406 dia	9T18Y1074G10	3	6 AWG to 250 MCM	5/16	4	6 AWG to 350 MCM	3/8
DX75C/DY75A DY75C	3 ph - 112.5 kVA (005)	(1) .563 dia	(2) .563 dia	9T18Y1075G10	7	6 AWG to 350 MCM	3/8	N/A	N/A	N/A
DX75A/DX76C/ DY76A/DY76C	3 ph - 150 kVA (006)	(1) .563 dia	(2) .563 dia	9T18Y1076G10	3	6 AWG to 350 MCM	3/8	4	4 AWG to 500 MCM	3/8
DX76A/DX77A DX77C/DY77A DY77C	3 ph - 225 kVA (007)	(2) .563 dia	(4) .563 dia	9T18Y1077G10	6	6 AWG to 350 MCM	3/8	8	4 AWG to 500 MCM	3/8
DX78A/DX78C DY78A/DY78C	3 ph - 300 kVA (008)	(2) .563 dia	(4) .563 dia	9T18Y1078G10	6	6 AWG to 350 MCM	3/8	6	2 AWG to 600 MCM	3/8
DX79A/DX79C	3 ph - 400/500 kVA (009)	(4) .563 dia	(6) .563 dia	9T18Y1079G10	9	6 AWG to 350 MCM	3/8	24	4 AWG to 500 MCM	3/8

¹Proximity of bus bars would prohibit dual lugs per bus bar



Enclosure Kits

Frame Size	Product Number
UX71A	9T18Y1071
UX71C	9T18Y1071
UX72A	9T18Y1072
UX73A	9T18Y1072
UX72C	9T18Y1072
UX73C	9T18Y1072
UY74A	9T18Y1074
UX74A	9T18Y1074
UY74C	9T18Y1074
UX74C	9T18Y1074
DY75A	9T18Y1075
DY75C	9T18Y1075
DX75C	9T18Y1075
DY76A	9T18Y1076
DY76C	9T18Y1076
DX75A	9T18Y1076
DX76C	9T18Y1076
DY77A	9T18Y1077
DY77C	9T18Y1077
DX76A	9T18Y1077
DX77A	9T18Y1077
DX77C	9T18Y1077
DY78A	9T18Y1078
DY78C	9T18Y1078
DX78A	9T18Y1078
DX78C	9T18Y1078
DX79A	9T18Y1079
DY79C	9T18Y1079

Front/Back Panel

Frame Size	Product Number
UX71A	9T18Y1071G03
UX71C	9T18Y1071G03
UX72A	9T18Y1072G03
UX73A	9T18Y1072G03
UX72C	9T18Y1072G03
UX73C	9T18Y1072G03
UY74A	9T18Y1074G03
UX74A	9T18Y1074G03
UY74C	9T18Y1074G03
UX74C	9T18Y1074G03
DY75A	9T18Y1075G03
DY75C	9T18Y1075G03
DX75C	9T18Y1075G03
DY76A	9T18Y1076G03
DY76C	9T18Y1076G03
DX75A	9T18Y1076G03
DX76C	9T18Y1076G03
DY77A	9T18Y1077G03
DY77C	9T18Y1077G03
DX76A	9T18Y1077G03
DX77A	9T18Y1077G03
DX77C	9T18Y1077G03
DY78A	9T18Y1078G03
DY78C	9T18Y1078G03
DX78A	9T18Y1078G03
DX78C	9T18Y1078G03
DX79A	9T18Y1079G03
DY79C	9T18Y1079G03

Side Panel

Frame Size	Product Number
UX71A	9T18Y1071G04
UX71C	9T18Y1071G04
UX72A	9T18Y1072G04
UX73A	9T18Y1072G04
UX72C	9T18Y1072G04
UX73C	9T18Y1072G04
UY74A	9T18Y1074G04
UX74A	9T18Y1074G04
UY74C	9T18Y1074G04
UX74C	9T18Y1074G04
DY75A	9T18Y1075G04
DY75C	9T18Y1075G04
DX75C	9T18Y1075G04
DY76A	9T18Y1076G04
DY76C	9T18Y1076G04
DX75A	9T18Y1076G04
DX76C	9T18Y1076G04
DY77A	9T18Y1077G04
DY77C	9T18Y1077G04
DX76A	9T18Y1077G04
DX77A	9T18Y1077G04
DX77C	9T18Y1077G04
DY78A	9T18Y1078G04
DY78C	9T18Y1078G04
DX78A	9T18Y1078G04
DX78C	9T18Y1078G04
DX79A	9T18Y1079G04
DY79C	9T18Y1079G04

Cover (Top) Panel

Frame Size	Product Number
UX71A	9T18Y1071G05
UX71C	9T18Y1071G05
UX72A	9T18Y1072G05
UX73A	9T18Y1072G05
UX72C	9T18Y1072G05
UX73C	9T18Y1072G05
UY74A	9T18Y1074G05
UX74A	9T18Y1074G05
UY74C	9T18Y1074G05
UX74C	9T18Y1074G05
DY75A	9T18Y1074G05
DY75C	9T18Y1074G05
DX75C	9T18Y1074G05
DY76A	9T18Y1076G05
DY76C	9T18Y1076G05
DX75A	9T18Y1076G05
DX76C	9T18Y1076G05
DY77A	9T18Y1077G05
DY77C	9T18Y1077G05
DX76A	9T18Y1077G05
DX77A	9T18Y1077G05
DX77C	9T18Y1077G05
DY78A	9T18Y1078G05
DY78C	9T18Y1078G05
DX78A	9T18Y1078G05
DX78C	9T18Y1078G05
DX79A	9T18Y1079G05
DY79C	9T18Y1079G05

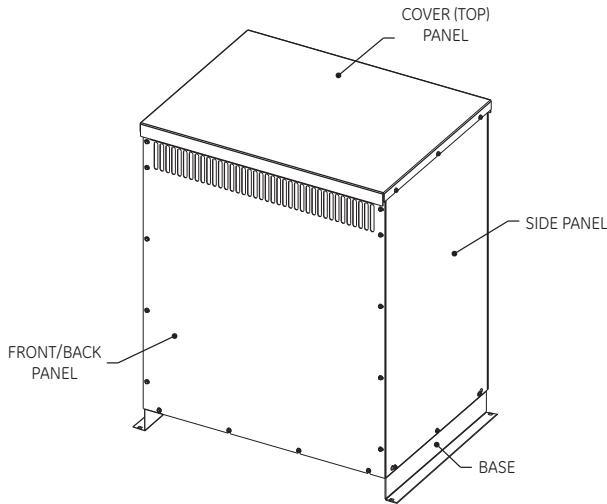

ENCLOSURE KIT: 1 COVER + 2 SIDES + 2 FRONTS

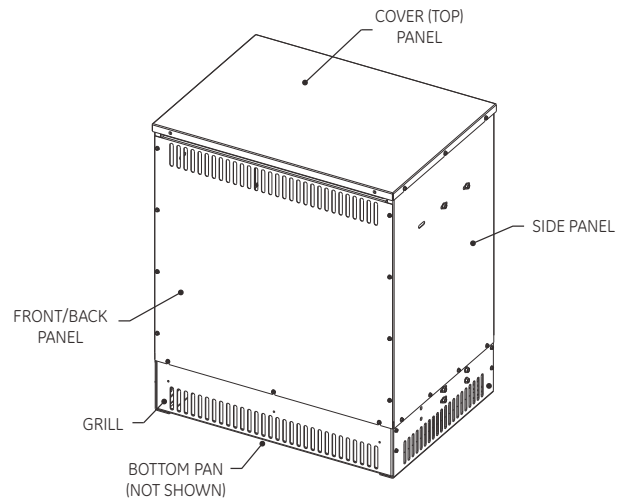

ENCLOSURE KIT: 1 COVER + 2 SIDES + 2 FRONTS

This style enclosure is used with the following frames:

UX71A	UY74C
UX71C	UX74C
UX72A	DY75A
UX72C	DY75C
UX73A	DX75A
UX73C	DX75C
UY74A	DY76A
UX74A	DY76C

This style enclosure is used with the following frames:

DX76A	DX79A
DX76C	DX79C
DX77A	YF171
DX77C	YF172
DY77A	YF173
DY77C	YF174
DY78C	YF175
DY78A	YF176
DX78A	YF177
DX78C	



Dry Type Transformers Wiring Diagrams

Section 10

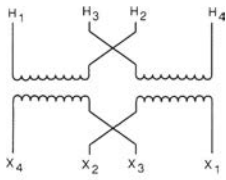

Diagram 1

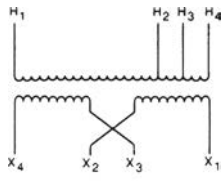

Diagram 2

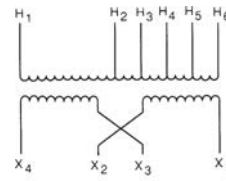

Diagram 3

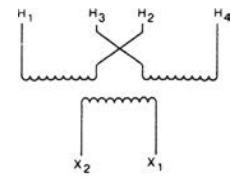

Diagram 4

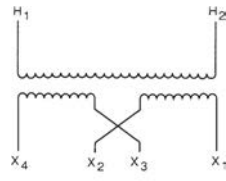

Diagram 5

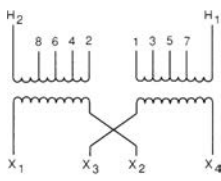

Diagram 6

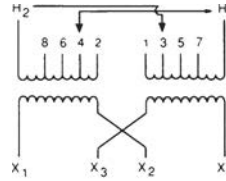

Diagram 7

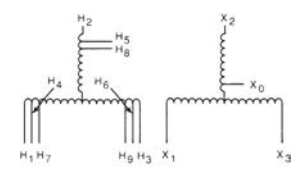

Diagram 8

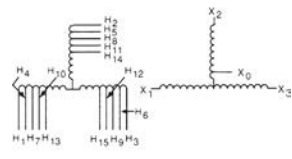

Diagram 9

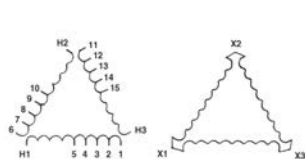

Diagram 10

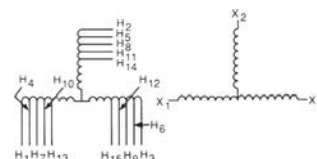

Diagram 11

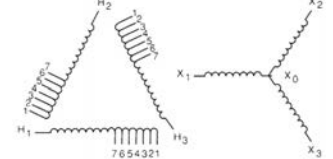

Diagram 12

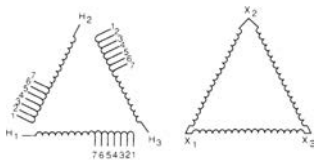

Diagram 13

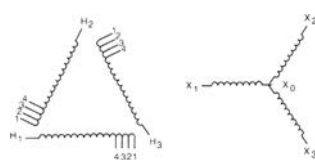

Diagram 14

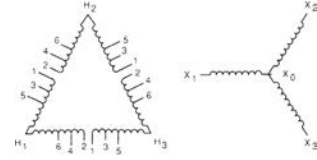

Diagram 15

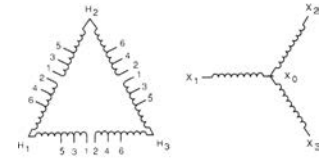

Diagram 16

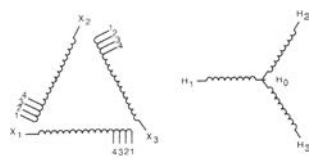

Diagram 17

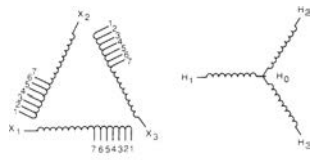

Diagram 18

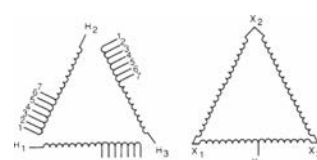

Diagram 19

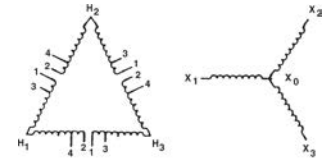

Diagram 20

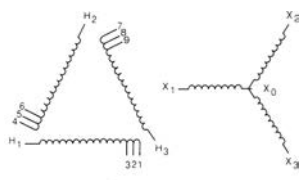

Diagram 21

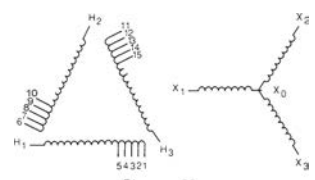

Diagram 22

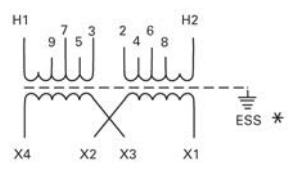

Diagram 23

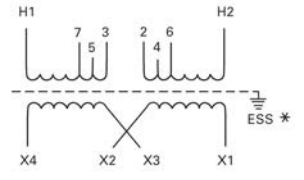

Diagram 24



1-Phase Vented QL Transformers

Frame Size	Outline Drawing No.	Height (in.)	Width (in.)	Depth (in.)
YF171	303B406AAP071	32.1	23.8	18.4
YF172	303B406AAP072	35.7	31.8	24
XV173	303B406AAP073	35.7	31.8	24
YF174	303B406AAP074	39.9	31.8	24
YF175	303B932AAP075	37.4	29.5	28.5
YF176	303B932AAP076	45.5	38.5	33
YF177	303B932AAP077	45.5	38.5	33



QL Transformer
(Front Panel Removed)

3-Phase, Vented, Non-Fan Cooled QL Transformers (9T8, 9T7, 9T6 models)

Includes General Purpose, K-Factor, K-Factor Low Noise, Low Noise, Guard I, Midtapped, Drive Isolation

Frame Size	Outline Drawing	Enclosure Dimensions			Mounting Feet Dimensions		Weight	
		Width (in.)	Depth (in.)	Height (in.)	Width (in.)	Depth (in.)	Painted (lbs.)	316 Stainless Steel (lbs.)
UX71A	303B111GEUXP71A	18.7	16.9	29.3	21.2	15.1	231	251
UX71C	303B111GEUXP71C	18.7	16.9	29.3	21.2	15.1	230	250
UX72A	303B111GEUXP72A	23.8	18.4	34.7	26.2	16.6	330	350
UX72C	303B111GEUXP72C	23.8	18.4	34.7	26.2	16.6	353	373
UX73A	303B111GEUXP73A	23.8	18.4	34.7	26.2	16.6	444	464
UX73C	303B111GEUXP73C	23.8	18.4	34.7	26.2	16.6	480	500
UY74A	303B111GEUY74A	31.8	24	35.7	34.3	22.3	561	581
UY74C	303B111GEUY74C	31.8	24	35.7	34.3	22.3	661	681
UX74A	303B111GEUXP74A	31.8	24	35.7	34.3	22.3	603	623
UX74C	303B111GEUXP74C	31.8	24	35.7	34.3	22.3	748	768
DY75A	303B111GEDYP75A	31.8	24	42.2	34.3	22.3	680	760
DY75C	303B111GEDYP75C	31.8	24	42.2	34.3	22.3	790	870
DX75A	303B111GEDXP75A	34.8	24	45.8	37.3	22.3	830	850
DX75C	303B111GEDXP75C	31.8	24	42.2	34.3	22.3	900	980
DY76A	303B111GEDYP76A	34.8	24	45.8	37.3	22.3	1030	1050
DY76C	303B111GEDYP76C	34.8	24	45.8	37.3	22.3	1085	1105
DX76A	303B112GEDXP76A	38.4	33	47.4	41.1	32	1250	Not available
DX76C	303B111GEDXP76C	34.8	24	45.8	37.3	22.3	1240	1260
DY77A	303B112GEDYP77A	38.4	33	47.4	41.4	32	1450	Not available
DY77C	303B112GEDYP77C	38.4	33	47.4	41.4	32	1610	Not available
DX77A	303B112GEDXP77A	38.4	33	47.4	41.4	32	1670	Not available
DY78A	303B112GEDYP78A	38.4	33	57.1	41.4	32	1670	Not available
DX77C	303B112GEDXP77C	38.4	33	47.4	41.4	32	1847	Not available
DY78C	303B112GEDYP78C	38.4	33	57.1	41.4	32	1970	Not available
DX78A	303B112GEDXP78A	38.4	33	57.1	41.4	32	1985	Not available
DX78C	303B112GEDXP78C	38.4	33	57.1	41.4	32	2150	Not available
DX79A	303B112GEDXP79A	46.5	37.8	65.7	50.1	37	2900	Not available
DX79C	303B112GEDXP79C	46.5	37.8	65.7	50.1	37	3720	Not available

Servicenter Transformers

Frame Size	Outline Drawing	Height (in.)	Width (in.)	Depth (in.)
16350	303B915AAP005	32.5	10.75	11.12
16600	303B915AAP007	32.5	10.75	11.12
19400	303B915AAP010	35	12.62	12.62
19500	303B915AAP015	35	12.62	12.62
50500	303B915AAP025	44.75	16.75	16
XV371	303B404AAP015	27.3	27.4	16.9
XV372	303B404AAP022	32.2	34.5	24
XV372	303B404AAP030	32.2	34.5	24
Y371C	303B404AAP015	27.3	27.4	16.9
Y372C	303B404AAP022	32.2	34.5	24
Y372C	303B404AAP030	32.2	34.5	24

QMS Transformers

Frame Size	Outline Drawing	Height (in.)	Width (in.)	Depth (in.)
16350	303B923AAP005	14.5	10.62	11
16400	303B923AAP005	14.5	10.62	11
16450	303B923AAP005	14.5	10.62	11
16600	303B923AAP007	17.06	10.62	11
19400	303B923AAP010	17.06	12.5	12.5
19450	303B923AAP010	17.06	12.5	12.5
19500	303B915AAP015	35	12.62	12.62
1619	303B922AAP001	14.50	10.75	11.12
1620	303B922AAP001	14.50	10.75	11.12
1921	303B922AAP003	17.12	12.62	12.75
1923	303B922AAP004	18.81	14.75	14.53
50500	303B915AAP025	44.75	16.75	16



Dry Type Transformers Dimensions

Section 10

Guard II Transformers

Frame Size	Outline Drawing No.	Height (In.)	Width (In.)	Depth (In.)
XV371	303B403AAP071	34.5	18.7	16.9
XV372	303B403AAP072	41.3	23.8	18.4
XV373	303B403AAP073	41.3	23.8	18.4
XV374	303B403AAP074	44.8	31.8	24
XV375	303B403AAP075	49.1	31.8	24

Guard III Harmonic Mitigating

Frame Size	Outline Drawing No.	Height (In.)	Width (In.)	Depth (In.)
H371C	303B431AAP071	32.3	23.8	18.4
H372C	303B431AAP072	35.7	31.8	24
H373C	303B431AAP073	35.7	31.8	24
H374C	303B431AAP074	39.9	31.8	24
H375C	303B931AAP075	45.5	38.6	33
H376C	303B931AAP076	45.4	38.5	33

TENV Transformers

Frame Size	Outline Drawing No.	Height (In.)	Width (In.)	Depth (In.)
XV372	303B405AAP072	41.3	23.8	18.4
XV373	303B405AAP073	41.3	23.8	18.4
XV374	303B405AAP074	44.8	31.8	24
XV375	303B405AAP075	49.1	31.8	24

QB Transformers

Frame Size	Outline Drawing No.	Height (In.)	Width (In.)	Depth (In.)
6100	303B920AAP001	6.38	5.12	3.25
6150	303B920AAP001	6.38	5.12	3.25
6200	303B920AAP001	6.38	5.12	3.25
8175	303B920AAP002	7.38	6.12	4.25
8200	303B920AAP002	7.38	6.12	4.25
10200	303B920AAP003	8.38	6.88	4.88
10225	303B920AAP003	8.38	6.88	4.88
12200	303B920AAP004	9.62	7.88	5.5
12225	303B920AAP004	9.62	7.88	5.5
12275	303B920AAP004	9.62	7.88	5.5
12300	303B920AAP004	9.62	7.88	5.5
14200	303B920AAP005	11.12	9.38	6.72
14225	303B920AAP005	11.12	9.38	6.72
14250	303B920AAP005	11.12	9.38	6.72
14300	303B920AAP005	11.12	9.38	6.72
14350	303B920AAP005	11.12	9.38	6.72
14400	303B920AAP005	11.12	9.38	6.72



Dry Type Transformers General Purpose Encapsulated Single-Phase NEMA 3R

Section 10

.050 - 3 kVA Indoor/Outdoor Type QB UL Listed C-UL Listed

Input Voltage	Output Voltage	kVA	Frequency (Hz)	Taps	Wiring Diagram No. ¹	Weight (Lbs)	Frame Size	Product Number
240 x 480 Volts, 480 Volts	120/240 Volts	0.05	60 Hz	No Taps	1	6	6100	9T51B0002
240 x 480 Volts	120/240 Volts	0.05	50 Hz	No Taps	1	6	6100	9T51B0502
240 x 480 Volts, 480 Volts	120/240 Volts	0.075	60 Hz	No Taps	1	6	6200	9T51B0003
240 x 480 Volts	120/240 Volts	0.075	50 Hz	No Taps	1	6	6200	9T51B0503
240 x 480 Volts, 480 Volts	120/240 Volts	0.1	60 Hz	No Taps	1	6	6200	9T51B0004
240 x 480 Volts	120/240 Volts	0.1	50 Hz	No Taps	1	6	6200	9T51B0504
240 x 480 Volts, 480 Volts	120/240 Volts	0.15	60 Hz	No Taps	1	10	8175	9T51B0005
240 x 480 Volts	120/240 Volts	0.15	50 Hz	No Taps	1	10	8175	9T51B0505
240 x 480 Volts, 480 Volts	120/240 Volts	0.25	60 Hz	No Taps	1	10	8175	9T51B0007
240 x 480 Volts	120/240 Volts	0.25	50 Hz	No Taps	1	10	8200	9T51B0507
240 x 480 Volts, 480 Volts	120/240 Volts	0.5	60 Hz	No Taps	1	16	10200	9T51B0008
240 x 480 Volts	120/240 Volts	0.5	50 Hz	No Taps	1	20	10225	9T51B0508
240 x 480 Volts, 480 Volts	120/240 Volts	0.75	60 Hz	No Taps	1	25	12200	9T51B0009
240 x 480 Volts	120/240 Volts	0.75	50 Hz	No Taps	1	25	12225	9T51B0509
240 x 480 Volts, 480 Volts	120/240 Volts	1	60 Hz	No Taps	1	25	12225	9T51B0010
240 x 480 Volts	120/240 Volts	1	50 Hz	No Taps	1	30	12275	9T51B0510
240 x 480 Volts, 480 Volts	120/240 Volts	1.5	60 Hz	No Taps	1	40	14200	9T51B0011
240 x 480 Volts	120/240 Volts	1.5	50 Hz	No Taps	1	40	14225	9T51B0511
240 x 480 Volts, 480 Volts	120/240 Volts	2	60 Hz	No Taps	1	45	14250	9T51B0012
240 x 480 Volts	120/240 Volts	2	50 Hz	No Taps	1	50	14300	9T51B0512
240 x 480 Volts, 480 Volts	120/240 Volts	3	60 Hz	No Taps	1	55	14350	9T51B0013
240 x 480 Volts	120/240 Volts	3	50 Hz	No Taps	1	60	14400	9T51B0513
480 Volts	120/240 Volts	0.5	50 Hz	(-2 5.0%)	2	20	10225	9T51B0548
480 Volts	120/240 Volts	0.75	50 Hz	(-2 5.0%)	2	25	12200	9T51B0549
480 Volts	120/240 Volts	1	60 Hz	(-2 5.0%)	2	25	12225	9T51B0050
480 Volts	120/240 Volts	1	50 Hz	(-2 5.0%)	2	30	12275	9T51B0550
480 Volts	120/240 Volts	1.5	60 Hz	(-2 5.0%)	2	40	14200	9T51B0051
480 Volts	120/240 Volts	1.5	50 Hz	(-2 5.0%)	2	40	14225	9T51B0551
480 Volts	120/240 Volts	2	60 Hz	(-2 5.0%)	2	45	14250	9T51B0052
480 Volts	120/240 Volts	2	50 Hz	(-2 5.0%)	2	50	14300	9T51B0552
480 Volts	120/240 Volts	3	60 Hz	(-2 5.0%)	2	55	14350	9T51B0053
480 Volts	120/240 Volts	3	60 Hz	(+2,-2 2.5%)	3	55	14350	9T51B0135
480 Volts	120/240 Volts	3	50 Hz	(-2 5.0%)	2	60	14400	9T51B0553
600 Volts	120/240 Volts	0.05	60 Hz	No Taps	5	6	6100	9T51B0082
600 Volts	120/240 Volts	0.075	60 Hz	No Taps	5	6	6200	9T51B0083
600 Volts	120/240 Volts	0.1	60 Hz	No Taps	5	6	6200	9T51B0084
600 Volts	120/240 Volts	0.1	50 Hz	No Taps	5	6	6200	9T51B0584
600 Volts	120/240 Volts	0.15	60 Hz	No Taps	5	10	8175	9T51B0085
600 Volts	120/240 Volts	0.25	60 Hz	No Taps	5	10	8175	9T51B0087
600 Volts	120/240 Volts	0.25	50 Hz	No Taps	5	10	8200	9T51B0587
600 Volts	120/240 Volts	0.5	60 Hz	No Taps	5	16	10200	9T51B0088
600 Volts	120/240 Volts	0.5	50 Hz	(-2 5.0%)	2	20	10225	9T51B0568
600 Volts	120/240 Volts	0.75	60 Hz	No Taps	5	25	12200	9T51B0089
600 Volts	120/240 Volts	0.75	50 Hz	(-2 5.0%)	2	25	12200	9T51B0569
600 Volts	120/240 Volts	1	60 Hz	(-2 5.0%)	2	25	12225	9T51B0070
600 Volts	120/240 Volts	1	60 Hz	No Taps	5	25	12225	9T51B0090
600 Volts	120/240 Volts	1	50 Hz	(-2 5.0%)	2	30	12275	9T51B0570
600 Volts	120/240 Volts	1.5	60 Hz	(-2 5.0%)	2	40	14200	9T51B0071
600 Volts	120/240 Volts	1.5	60 Hz	No Taps	5	40	14200	9T51B0091
600 Volts	120/240 Volts	1.5	50 Hz	(-2 5.0%)	2	40	14225	9T51B0571
600 Volts	120/240 Volts	2	60 Hz	(-2 5.0%)	2	45	14250	9T51B0072
600 Volts	120/240 Volts	2	60 Hz	No Taps	5	45	14250	9T51B0092
600 Volts	120/240 Volts	2	50 Hz	(-2 5.0%)	2	50	14300	9T51B0572
600 Volts	120/240 Volts	2	50 Hz	No Taps	5	50	14300	9T51B0592
600 Volts	120/240 Volts	3	60 Hz	(-2 5.0%)	2	55	14350	9T51B0073
600 Volts	120/240 Volts	3	60 Hz	No Taps	5	55	14350	9T51B0093
600 Volts	120/240 Volts	3	50 Hz	(-2 5.0%)	2	60	14400	9T51B0573
600 Volts	120/240 Volts	3	50 Hz	No Taps	5	60	14400	9T51B0593

¹See page 10-45 for wiring diagrams.



Dry Type Transformers General Purpose Encapsulated Single-Phase NEMA 3R

Section 10

.050 - 3 kVA Indoor/Outdoor Type QB UL Listed C-UL Listed

Input Voltage	Output Voltage	kVA	Frequency (Hz)	Taps	Wiring Diagram No. ¹	Weight (Lbs)	Frame Size	Product Number
120 x 240 Volts	120/240 Volts	0.05	60 Hz	No Taps	1	6	6100	9T51B0022
120 x 240 Volts	120/240 Volts	0.1	60 Hz	No Taps	1	6	6200	9T51B0024
120 x 240 Volts	120/240 Volts	0.15	60 Hz	No Taps	1	10	8175	9T51B0025
120 x 240 Volts	120/240 Volts	0.25	60 Hz	No Taps	1	10	8175	9T51B0027
120 x 240 Volts	120/240 Volts	0.5	60 Hz	No Taps	1	16	10200	9T51B0028
120 x 240 Volts	120/240 Volts	0.75	60 Hz	No Taps	1	25	12200	9T51B0029
120 x 240 Volts	120/240 Volts	1	60 Hz	No Taps	1	25	12225	9T51B0030
120 x 240 Volts	120/240 Volts	1.5	60 Hz	No Taps	1	40	14200	9T51B0031
120 x 240 Volts	120/240 Volts	2	60 Hz	No Taps	1	45	14250	9T51B0032
120 x 240 Volts	120/240 Volts	3	60 Hz	No Taps	1	60	14400	9T51B0033
208 Volts	120/240 Volts	0.5	60 Hz	No Taps	4	16	10200	9T51B0158
208 Volts	120/240 Volts	0.75	60 Hz	No Taps	4	25	12200	9T51B0159
208 Volts	120/240 Volts	1	60 Hz	No Taps	4	25	12225	9T51B0160
208 Volts	120/240 Volts	2	60 Hz	No Taps	4	45	14250	9T51B0156
208 Volts	120/240 Volts	3	60 Hz	No Taps	4	55	14350	9T51B0157

.050 - 3 kVA Indoor/Outdoor Type QB UL Listed C-UL Listed

Input Voltage	Output Voltage	kVA	Frequency (Hz)	Taps	Wiring Diagram No. ¹	Weight (Lbs)	Frame Size	Product Number
277 Volts	120/240 Volts	0.25	60 Hz	(-2 5.1%)	2	10	8175	9T51B0187
277 Volts	120/240 Volts	0.5	60 Hz	(-2 5.1%)	2	16	10200	9T51B0188
277 Volts	120/240 Volts	0.75	60 Hz	(-2 5.1%)	2	25	12200	9T51B0189
277 Volts	120/240 Volts	1	60 Hz	(-2 5.1%)	2	30	12275	9T51B0190
277 Volts	120/240 Volts	1.5	60 Hz	(-2 5.1%)	2	40	14200	9T51B0191
277 Volts	120/240 Volts	2	60 Hz	(-2 5.1%)	2	45	14250	9T51B0192
277 Volts	120/240 Volts	3	60 Hz	(-2 5.1%)	2	55	14350	9T51B0193
380/400/416 Volts	120/240 Volts	0.05	50 Hz	No Taps	2	6	6150	9T51B0162
380/400/416 Volts	120/240 Volts	0.15	50 Hz	No Taps	2	10	8175	9T51B0165
380/400/416 Volts	120/240 Volts	0.25	50 Hz	No Taps	2	10	8200	9T51B0167
380/400/416 Volts	120/240 Volts	0.5	50 Hz	No Taps	2	20	10225	9T51B0168
380/400/416 Volts	120/240 Volts	0.75	50 Hz	No Taps	2	25	12200	9T51B0169
380/400/416 Volts	120/240 Volts	1	50 Hz	No Taps	2	30	12275	9T51B0170
380/400/416 Volts	120/240 Volts	1.5	50 Hz	No Taps	2	40	14225	9T51B0171
380/400/416 Volts	120/240 Volts	2	50 Hz	No Taps	2	50	14300	9T51B0172
380/400/416 Volts	120/240 Volts	3	50 Hz	No Taps	2	60	14400	9T51B0173

¹See page 10-45 for wiring diagrams.



Dry Type Transformers General Purpose Encapsulated Single-Phase NEMA 3R

Section 10

5 - 25 kVA Indoor/Outdoor Type QMS 115°C Rise UL Listed C-UL Listed

Input Voltage	Output Voltage	kVA	Frequency (Hz)	Taps	Wiring Diagram No. ¹	Weight (Lbs)	Frame Size	Product Number
120 x 240 Volts	120/240 Volts	5	60 Hz	No Taps	1	103	16350	9T21B1001G02
120 x 240 Volts	120/240 Volts	7.5	60 Hz	No Taps	1	147	16600	9T21B1002G02
120 x 240 Volts	120/240 Volts	10	60 Hz	No Taps	1	198	19400	9T21B1003G02
120 x 240 Volts	120/240 Volts	10	60 Hz	No Taps	1	198	19400	9T21B1054G02
120 x 240 Volts	120/240 Volts	15	60 Hz	No Taps	1	220	19500	9T21B9101
120 x 240 Volts	120/240 Volts	15	60 Hz	No Taps	1	233	19550	9T21B9131
120 x 240 Volts	120/240 Volts	25	60 Hz	No Taps	1	233	19550	9T21B9102
208 Volts	120/240 Volts	5	60 Hz	No Taps	4	103	16350	9T21B1028G02
208 Volts	120/240 Volts	7.5	60 Hz	No Taps	4	147	16600	9T21B1029G02
208 Volts	120/240 Volts	10	60 Hz	No Taps	4	198	19400	9T21B1030G02
208 Volts	120/240 Volts	15	60 Hz	No Taps	4	220	19500	9T21B9119
208 Volts	120/240 Volts	25	60 Hz	No Taps	4	388	50500	9T21B9120

¹See page 10-45 for wiring diagrams.

²For Outdoor NEMA 3R Enclosure add suffix G62 to product number.

5 - 25 kVA Indoor/Outdoor Type QMS 115°C Rise UL Listed C-UL Listed

Input Voltage	Output Voltage	kVA	Frequency (Hz)	Taps	Wiring Diagram No. ¹	Weight (Lbs)	Frame Size	Product Number
277 Volts	120/240 Volts	5	60 Hz	(-2 5.1%)	2	103	16350	9T21B1046G02
277 Volts	120/240 Volts	5	60 Hz	(-2 2.5%)	2	103	16350	9T21B1265G02
277 Volts	120/240 Volts	7.5	60 Hz	(-2 5.1%)	2	147	16600	9T21B1047G02
277 Volts	120/240 Volts	10	60 Hz	(-2 5.1%)	2	198	19400	9T21B1048G02
277 Volts	120/240 Volts	10	60 Hz	(-2 2.5%)	2	198	19400	9T21B1266G02
277 Volts	120/240 Volts	15	60 Hz	(-2 5.1%)	2	220	19500	9T21B9143
277 Volts	120/240 Volts	25	60 Hz	(-2 4.7%)	2	388	50500	9T21B9144

¹See page 10-45 for wiring diagrams.

5 - 25 kVA Indoor/Outdoor Type QMS 115°C Rise UL Listed C-UL Listed

Input Voltage	Output Voltage	kVA	Frequency (Hz)	Taps	Wiring Diagram No. ¹	Weight (Lbs)	Frame Size	Product Number
240 x 480 Volts	120/240 Volts	5	60	No Taps	1	103	16350	9T21B1004G02
240 x 480 Volts	120/240 Volts	5	50	No Taps	1	115	16400	9T21B1055G02
240 x 480 Volts	120/240 Volts	7.5	60	No Taps	1	147	16600	9T21B1005G02
240 x 480 Volts	120/240 Volts	7.5	50	No Taps	1	174	16600	9T21B1056G02
240 x 480 Volts	120/240 Volts	10	60	No Taps	1	198	19400	9T21B1006G02
240 x 480 Volts	120/240 Volts	10	50	No Taps	1	198	19400	9T21B1057G02
240 x 480 Volts	120/240 Volts	15	60	No Taps	1	220	19500	9T21B9103
240 x 480 Volts	120/240 Volts	15	50	No Taps	1	233	19550	9T21B9133
240 x 480 Volts	120/240 Volts	25	60	No Taps	1	388	50500	9T21B9104
240 x 480 Volts	120/240 Volts	25	50	No Taps	1	428	50600	9T21B9134
480 Volts	120/240 Volts	5	60	(-2 5.0%)	2	103	16350	9T21B1007G02
480 Volts	120/240 Volts	5	60	(+2,-2 2.5%)	3	103	16350	9T21B1013G02
480 Volts	120/240 Volts	7.5	60	(-2 5.0%)	2	147	16600	9T21B1008G02
480 Volts	120/240 Volts	7.5	60	(+2,-2 2.5%)	3	147	16600	9T21B1014G02
480 Volts	120/240 Volts	10	60	(-2 4.9%)	2	198	19400	9T21B1009G02
480 Volts	120/240 Volts	10	60	(+2,-2 2.6%)	3	198	19400	9T21B1015G02
480 Volts	120/240 Volts	15	60	(-2 5.0%)	2	220	19500	9T21B9105
480 Volts	120/240 Volts	15	60	(+2,-2 2.5%)	3	220	19500	9T21B9109
480 Volts	120/240 Volts	25	60	(-2 5.0%)	2	388	50500	9T21B9106
480 Volts	120/240 Volts	25	60	(+2,-2 2.5%)	3	388	50500	9T21B9110
600 Volts	120/240 Volts	5	60	No Taps	5	103	16350	9T21B1016G02
600 Volts	120/240 Volts	5	60	(-2 5.0%)	2	103	16350	9T21B1019G02
600 Volts	120/240 Volts	5	60	(+2,-2 2.5%)	107	16350	9T21B1025G02	
600 Volts	120/240 Volts	7.5	60	(-2 5.0%)	2	147	16600	9T21B1020G02
600 Volts	120/240 Volts	10	60	(-2 4.9%)	2	198	19400	9T21B1021G02
600 Volts	120/240 Volts	15	60	No Taps	5	220	19500	9T21B9111
600 Volts	120/240 Volts	15	60	(-2 4.8%)	2	220	19500	9T21B9113
600 Volts	120/240 Volts	25	60	(-2 5.0%)	2	388	50500	9T21B9114

¹See page 10-45 for wiring diagrams.



Dry Type Transformers Buck-Boost Encapsulated Autotransformers For Bucking and Boosting Voltage

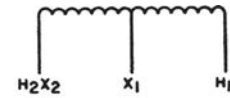

Wiring Diagram: Single-Phase

Application

For General Lighting and Power Service

Autotransformers are more economical than isolation transformers designed to carry the same load. Within their voltage limitations, they will perform the same function as transformers with the exception of insulating two circuits. You can use these autotransformers to obtain 120 Volts from a 240 Volt circuit, to derive a neutral on a 240 Volt, two-wire circuit, or to balance a 120/240 Volt, three-wire circuit. They also may be used in banks on polyphase circuits. See footnotes below.

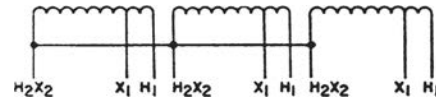

Wiring Diagram: Three-Phase

For Bucking or Boosting Voltage of Single-Phase Indoor/Outdoor Type QB 60 Hz UL Listed CSA Certified¹

Input Voltage	Output Voltage	kVA ²	Height (in)	Width (in)	Depth (in)	Approx. Net Weight (Lbs.)	Frame Size	Product Number
240/120 Volts	120 or 240/120 Volts (Three-Wire)	0.5	7.38	6.13	4.25	10	8175	9T51B0136
240/120 Volts	120 or 240/120 Volts (Three-Wire)	0.75	8.38	6.88	4.88	16	10200	9T51B0137
240/120 Volts	120 or 240/120 Volts (Three-Wire)	1	8.38	6.88	4.88	16	10200	9T51B0138
240/120 Volts	120 or 240/120 Volts (Three-Wire)	1.5	9.63	7.88	5.5	25	12200	9T51B0139
240/120 Volts	120 or 240/120 Volts (Three-Wire)	2	9.63	7.88	5.5	25	12225	9T51B0140
240/120 Volts	120 or 240/120 Volts (Three-Wire)	3	11.13	9.38	6.75	40	14200	9T51B0141
240/120 Volts	120 or 240/120 Volts (Three-Wire)	5	11.13	9.38	6.75	60	14400	9T51B0142

¹Through 3 kVA

For Bucking or Boosting Voltage of Single-Phase Indoor/Outdoor Type QMS 60 Hz UL Listed CSA Certified

Input Voltage	Output Voltage	kVA ²	Height (in)	Width (in)	Depth (in)	Approx. Net Weight (Lbs.)	Frame Size	Product Number
240/120 Volts	120 or 240/120 Volts (Three-Wire)	10	14.50	10.62	11.00	103	16350	9T21B4553G02
240/120 Volts	120 or 240/120 Volts (Three-Wire)	15	17.06	10.62	11.00	147	16600	9T21B9201
240/120 Volts	120 or 240/120 Volts (Three-Wire)	25	17.06	12.50	12.50	220	19500	9T21B9202

²kVA output at 120 Volts, two-wire, or allowable unbalance at 240/120 Volts, three-wire.

For Boosting Voltage of Three-Phase Indoor/Outdoor Type QB 60 Hz UL Listed

Input Voltage	Output Voltage	kVA ³	Height (in)	Width (in)	Depth (in)	Approx. Net Weight (Lbs.)	Frame Size	Product Number
208Y/120 Volts	230/133 Volts	6	7.38	6.13	4.25	10	8175	9T51B0143
208Y/120 Volts	230/133 Volts	9	8.38	6.88	4.88	16	10200	9T51B0144
208Y/120 Volts	230/133 Volts	15	8.38	6.88	4.88	20	10225	9T51B0145
208Y/120 Volts	230/133 Volts	30	9.63	7.88	5.50	30	12275	9T51B0146
208Y/120 Volts	230/133 Volts	45	11.13	9.38	6.75	40	14200	9T51B0147
208Y/120 Volts	230/133 Volts	75	11.13	9.38	6.75	60	14400	9T51B0148
208Y/120 Volts	240/120 Volts	6	7.38	6.13	4.25	10	8175	9T51B0150
208Y/120 Volts	240/120 Volts	15	9.63	7.88	5.50	25	12200	9T51B0152
208Y/120 Volts	240/120 Volts	30	11.13	9.38	6.75	40	14200	9T51B0153
208Y/120 Volts	240/120 Volts	45	11.13	9.38	6.75	45	14250	9T51B0154

³Bank of three single-phase autotransformers to be connected wye. Price is for one single unit. Dimensions and weights are for each unit in bank. Each single autotransformer is rated 1/3 of the bank kVA rating. Order three single-phase transformers for each three-phase bank.

Conversion Chart

Decimal	Fraction
.13	1/8
.38	3/8
.63	5/8
.88	7/8



Dry Type Transformers

Buck-Boost

Encapsulated

For Bucking and Boosting Voltage

Product Description

Buck boost transformers are small, single-phase, dry type distribution transformers designed and shipped as insulating/isolating transformers. They have a dual voltage primary and a dual voltage secondary. These transformers can be connected for a wide range of voltage combinations. The most common use is to buck (lower) or boost (raise) the supply voltage a small amount, usually 5 to 27%. Buck boost transformers comply with NEC Article 210-9, Exception 1, when field connected as an autotransformer.

GE bucking and boosting transformers provide an economical and convenient means for bucking or boosting voltage, usually no more than $\pm 20\%$ on single- and three-phase circuits. They are compact, relatively light in weight, and can be easily installed for indoor or outdoor service.

Buck-boost transformers are employed primarily for boosting single- and three-phase circuits by connecting them as autotransformers. When connected as an autotransformer, only the low-voltage, high-current capacity secondary windings are required to carry the load. Because this load is only transformed over a small change in voltage, the buck-boost transformer can handle loads many times its nameplate kVA rating.

The transformers with series-multiple 12/24, 24/48, or 16/32 Volt secondary windings are suitable for a wide variety of applications. Two or more units can be used in various combinations to obtain many other special voltages. (For fluctuating voltage conditions, refer to Power Conditioning Equipment Products section starting on page 10-36).

Advantages

- Efficient insulating materials permit compact size and light weight
- Dual voltage primary and dual voltage secondary for maximum versatility
- Large, front-accessible wiring compartment permits fast, easy wiring
- Convenient conduit knockouts located on side, bottom and back of wiring compartment
- GE Buck-Boost Transformer Selector makes selection fast and easy
- Many GE buck-boost transformers fit competitor mounting footprints
- Indoor or outdoor service

Key Features

- Convenient and least expensive method of matching line voltage with equipment voltage
- More efficient than equivalent isolation transformers
- Ability to handle loads up to 20 times nameplate rating when connected as an autotransformer
- Ideal for changing line voltages by small amounts
- Primary voltages include 120V, 240V and 480V
- Secondary voltages include 12V, 16V, 24V, 32V, 48V
- UL and cUL Listed



Indoor/Outdoor Type QB Transformer; Single-Phase

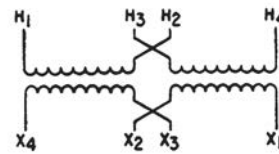

Wiring Diagram for Low Voltage Loads

- Qualified to the seismic requirements of IEEE-693-1997 and IBC-2003
- ABS (American Bureau of Shipping) Type Approved

Applications

- International voltage adaptation
- Commercial and industrial air conditioning
- Heating systems
- Induction motors
- Voltage line drop correction
- Landscape lighting
- Low-voltage lighting
- Marine and Offshore - ABS Classed Vessels

Efficient operation of electrical equipment requires that line voltage be at or near the nameplate rating of the equipment. In order to match available line voltage (whether it be too high or low) with equipment voltage, buck-boost transformers provide the most convenient and least expensive method.

Do not use buck-boost transformers to solve a fluctuating voltage problem. They should be used to compensate for high- or low-voltage conditions only when the available line voltage is reasonably constant.



Dry Type Transformers

Buck-Boost

Encapsulated

For Bucking and Boosting Voltage

Single-Phase Indoor/Outdoor Type QB 60 Hz UL Listed C-UL Listed

Input Voltage	Output Voltage	kVA	Height (in)	Width (in)	Depth (in)	Approx. Net Weight (Lbs.)	Frame Size	Product Number
120/240 Volts	12/24 Volts	0.05	6.38	5.12	3.25	6	6100	9T51B0102
120/240 Volts	12/24 Volts	0.075	6.38	5.12	3.25	6	6200	9T51B0103
120/240 Volts	12/24 Volts	0.1	6.38	5.12	3.25	6	6200	9T51B0104
120/240 Volts	12/24 Volts	0.15	7.38	6.12	4.25	10	8175	9T51B0105
120/240 Volts	12/24 Volts	0.25	7.38	6.12	4.25	10	8175	9T51B0107
120/240 Volts	12/24 Volts	0.5	8.38	6.88	4.88	20	10225	9T51B0108
120/240 Volts	12/24 Volts	0.75	9.62	7.88	5.50	25	12200	9T51B0109
120/240 Volts	12/24 Volts	1	9.62	7.88	5.50	25	12225	9T51B0110
120/240 Volts	12/24 Volts	1.5	11.12	9.38	6.72	40	14200	9T51B0111
120/240 Volts	12/24 Volts	2	11.12	9.38	6.72	50	14300	9T51B0112
120/240 Volts	12/24 Volts	3		9.38	6.72	55	14350	9T51B0113
120/240 Volts	16/32 Volts	0.05	6.38	5.12	3.25	6	6100	9T51B0122
120/240 Volts	16/32 Volts	0.075	6.38	5.12	3.25	6	6200	9T51B0123
120/240 Volts	16/32 Volts	0.1	6.38	5.12	3.25	6	6200	9T51B0124
120/240 Volts	16/32 Volts	0.15	7.38	6.12	4.25	10	8175	9T51B0125
120/240 Volts	16/32 Volts	0.25	7.38	6.12	4.25	10	8175	9T51B0127
120/240 Volts	16/32 Volts	0.5	8.38	6.88	4.88	20	10225	9T51B0128
120/240 Volts	16/32 Volts	0.75	9.62	7.88	5.50	25	12200	9T51B0129
120/240 Volts	16/32 Volts	1	9.62	7.88	5.50	30	12300	9T51B0130
120/240 Volts	16/32 Volts	1.5	11.12	9.38	6.72	40	14200	9T51B0131
120/240 Volts	16/32 Volts	2	11.12	9.38	6.72	50	14300	9T51B0132
120/240 Volts	16/32 Volts	3		9.38	6.72	55	14350	9T51B0133
240/480 Volts	24/48 Volts	0.05	6.38	5.12	3.25	6	6100	9T51B0202
240/480 Volts	24/48 Volts	0.075	6.38	5.12	3.25	6	6200	9T51B0203
240/480 Volts	24/48 Volts	0.1	6.38	5.12	3.25	6	6200	9T51B0204
240/480 Volts	24/48 Volts	0.15	7.38	6.12	4.25	10	8175	9T51B0205
240/480 Volts	24/48 Volts	0.25	7.38	6.12	4.25	10	8175	9T51B0207
240/480 Volts	24/48 Volts	0.5	8.38	6.88	4.88	20	10225	9T51B0208
240/480 Volts	24/48 Volts	0.75	9.62	7.88	5.50	25	12200	9T51B0209
240/480 Volts	24/48 Volts	1	9.62	7.88	5.50	30	12275	9T51B0210
240/480 Volts	24/48 Volts	1.5	11.12	9.38	6.72	40	14200	9T51B0211
240/480 Volts	24/48 Volts	2	11.12	9.38	6.72	50	14300	9T51B0212
240/480 Volts	24/48 Volts	3	11.12	9.38	6.72	55	14350	9T51B0213

Single-Phase Indoor/Outdoor Type QMS 60 Hz UL Listed C-UL Listed

Input Voltage	Output Voltage	kVA	Height (in)	Width (in)	Depth (in)	Approx. Net Weight (Lbs.)	Frame Size	Product Number
120/240 Volts	12/24 Volts	5	14.5	10.62	11	103	16350	9T21B1037G02
120/240 Volts	16/32 Volts	5	14.5	10.62	11	115	16400	9T21B1040G02

Single-Phase Indoor/Outdoor Type QMS 50 Hz UL Listed C-UL Listed

Input Voltage	Output Voltage	kVA	Height (in)	Width (in)	Depth (in)	Approx. Net Weight (Lbs.)	Frame Size	Product Number
120/240 Volts	12/24 Volts	5	14.5	10.62	11	115	16400	9T21B1061G02
120/240 Volts	16/32 Volts	5	14.5	10.62	11	127	16450	9T21B1064G02

NOTE: In addition to bucking or boosting low circuit voltages to related value, these transformers can be used as two winding transformers to supply the rated nameplate low voltages, 12 to 48 Volts, two-wire or 12/24 to 24/48 Volts, three-wire. Also available in 50/60 Hz ratings.



Dry Type Transformers Buck-Boost Selection Tables Encapsulated For Bucking and Boosting Voltage

5-Step Selection

The tables on these pages greatly facilitate buck-boost transformer selection. Simply follow these five easy steps:

1. Refer to the table having the same "output voltage" as the equipment you want to operate. For example, if you are installing a 230 Volt single-phase air conditioner, use the 230 Volt table.
2. Different available "line voltages" are listed across the top of each table. Select the line voltage column closest to your actual supply. If your available line voltage is exactly midway between two listed voltage levels, you may use either voltage column. For example, in the 230 Volt table, if you have 212 available, use either the 208 or the 216 column.
3. Read down the available line voltage column until you reach the rated load kVA of the equipment you want to operate or "the next higher kVA" rating. For example, in the 230 Volt table under the 208 available line voltage column, you want to operate an air conditioner rated 2 kVA. Since 2 kVA is not listed as such, you must read down to the next higher value or 2.4 kVA.

4. Once you have established this point, read across to the far left column for the exact GE buck-boost model number for your application. For example, the 230 Volt table under the 208 column for a 2 kVA air conditioner, read across from 2.4 (next higher kVA rating) and the model number is 9T51B0107.
5. Connect the buck-boost transformer you have selected per the connection diagram specified at the "bottom" of the available line voltage column you used. For example, if you used the 208 column, you would connect the buck-boost transformer per connection diagram A. That's all there is to it! The transformer you've selected will meet your exact requirements when connected in the specified manner.

The formula for calculating single-phase kVA is:

$$\frac{\text{Load Voltage} \times \text{Full Load Amps}}{1000}$$

The formula for calculating three-phase kVA is:

$$\frac{1.732 \times \text{Load Voltage} \times \text{Load Amps}}{1000}$$

Table 1
230 Volts Output, 60 Hertz, Single-Phase

Product Number	Available Line Voltage									
	192	203	208	216	219	242	245	353	261	276
	Load kVA ¹									
9T51B0102	—	—	0.480	—	0.960	1.0	—	0.530	—	—
9T51B0122	—	0.360	—	0.720	—	—	0.770	—	0.410	—
9T51B0202	0.240	—	—	—	—	—	—	—	—	0.288
9T51B0103	—	—	0.720	—	1.5	1.6	—	0.800	—	—
9T51B0123	—	0.540	—	1.1	—	—	1.2	—	0.620	—
9T51B0203	0.359	—	—	—	—	—	—	—	—	0.431
9T51B0104	—	—	0.960	—	2.0	2.1	—	1.1	—	—
9T51B0124	—	0.720	—	1.5	—	—	1.6	—	0.820	—
9T51B0204	0.479	—	—	—	—	—	—	—	—	0.575
9T51B0105	—	—	1.5	—	2.9	3.1	—	1.6	—	—
9T51B0125	—	1.1	—	2.2	—	—	2.3	—	1.3	—
9T51B0205	0.719	—	—	—	—	—	—	—	—	0.863
9T51B0107	—	—	2.4	—	4.8	5.1	—	2.7	—	—
9T51B0127	—	1.8	—	3.6	—	—	3.9	—	2.1	—
9T51B0207	1.2	—	—	—	—	—	—	—	—	1.4
9T51B0108	—	—	4.8	—	9.6	10.1	—	5.3	—	—
9T51B0128	—	3.6	—	7.2	—	—	7.7	—	4.1	—
9T51B0208	2.4	—	—	—	—	—	—	—	—	2.9
9T51B0109	—	—	7.2	—	14.4	15.2	—	7.9	—	—
9T51B0129	—	5.4	—	10.8	—	—	11.5	—	6.2	—
9T51B0209	3.6	—	—	—	—	—	—	—	—	4.3
9T51B0110	—	—	9.6	—	19.2	20.2	—	10.6	—	—
9T51B0130	—	7.2	—	14.4	—	—	15.4	—	8.2	—
9T51B0210	4.8	—	—	—	—	—	—	—	—	5.7
9T51B0111	—	—	14.4	—	28.8	30.3	—	15.9	—	—
9T51B0131	—	10.8	—	21.6	—	—	23.0	—	12.3	—
9T51B0211	7.2	—	—	—	—	—	—	—	—	8.6
9T51B0112	—	—	19.1	—	38.4	40.4	—	21.1	—	—
9T51B0132	—	14.4	—	28.8	—	—	30.7	—	16.4	—
9T51B0212	9.6	—	—	—	—	—	—	—	—	11.5
9T51B0113	—	—	28.7	—	57.5	60.5	—	31.7	—	—
9T51B0133	—	21.6	—	43.2	—	—	46.0	—	24.5	—
9T51B0213	14.4	—	—	—	—	—	—	—	—	17.3
9T21B1037G02	—	—	47.8	—	95.9	100.9	—	52.7	—	—
9T21B1040G02	—	36.0	—	72.0	—	—	77.0	—	40.8	—
Connection Diagram	C	A	A	B	B	B	B	A	A	C
Page 10-61										

¹The load kVA is the maximum load at voltages shown when transformers are connected as autotransformers according to the diagram referenced.



Dry Type Transformers Buck-Boost Selection Tables Encapsulated For Bucking and Boosting Voltage

Table 2
240 Volts Output, 60 Hertz, Single-Phase

Product Number	Available Line Voltage									
	200	212	218	225	229	252	256	264	272	288
	Load kVA ¹									
9T51B0102	—	—	0.500	—	1.0	1.1	—	0.6	—	—
9T51B0122	—	0.380	—	0.750	—	—	0.800	—	0.430	—
9T51B0202	0.250	—	—	—	—	—	—	—	—	0.300
9T51B0103	—	—	0.750	—	1.5	1.6	—	0.825	—	—
9T51B0123	—	0.570	—	1.2	—	—	1.2	—	0.640	—
9T51B0203	0.375	—	—	—	—	—	—	—	—	0.391
9T51B0104	—	—	1.0	—	2.0	2.1	—	1.1	—	—
9T51B0124	—	0.750	—	1.5	—	—	1.6	—	0.850	—
9T51B0204	0.500	—	—	—	—	—	—	—	—	0.522
9T51B0105	—	—	1.5	—	3.0	3.2	—	1.7	—	—
9T51B0125	—	1.2	—	2.3	—	—	2.4	—	1.3	—
9T51B0205	0.750	—	—	—	—	—	—	—	—	0.782
9T51B0107	—	—	2.5	—	5.0	5.3	—	2.8	—	—
9T51B0127	—	1.9	—	3.8	—	—	4.0	—	2.2	—
9T51B0207	1.3	—	—	—	—	—	—	—	—	1.4
9T51B0108	—	—	5.0	—	10.0	10.5	—	5.5	—	—
9T51B0128	—	3.8	—	7.5	—	—	8.0	—	4.3	—
9T51B0208	2.5	—	—	—	—	—	—	—	—	2.6
9T51B0109	—	—	7.5	—	15.0	15.8	—	8.3	—	—
9T51B0129	—	5.7	—	11.3	—	—	12.0	—	6.4	—
9T51B0209	3.8	—	—	—	—	—	—	—	—	4.0
9T51B0110	—	—	10.0	—	20.0	21.0	—	11.0	—	—
9T51B0130	—	7.5	—	15.0	—	—	16.0	—	8.5	—
9T51B0210	5.0	—	—	—	—	—	—	—	—	5.2
9T51B0111	—	—	15.0	—	30.0	31.5	—	16.5	—	—
9T51B0131	—	11.3	—	22.5	—	—	24.0	—	12.8	—
9T51B0211	7.5	—	—	—	—	—	—	—	—	7.8
9T51B0112	—	—	20.0	—	40.0	42.6	—	22.0	—	—
9T51B0132	—	15.0	—	30.0	—	—	32.0	—	17.0	—
9T51B0212	10.0	—	—	—	—	—	—	—	—	10.4
9T51B0113	—	—	30.0	—	60.0	63.0	—	33.0	—	—
9T51B0133	—	22.5	—	45.0	—	—	48.0	—	25.5	—
9T51B0213	15.0	—	—	—	—	—	—	—	—	15.6
9T21B1037G02	—	—	50.0	—	100.0	105.0	—	55.0	—	—
9T21B1040G02	—	37.5	—	75.0	—	—	80.0	—	42.5	—
Connection Diagram	C	A	A	B	B	B	B	A	A	C

¹The load kVA is the maximum load at voltages shown when transformers are connected as autotransformers according to the diagram referenced.



Dry Type Transformers Buck-Boost Selection Tables Encapsulated For Bucking and Boosting Voltage

Section 10

Table 3
115 Volts Output, 60 Hertz, Single-Phase

Product Number	Available Line Voltage							
	91	96	101	105	127	130	138	146
	Load kVA ¹							
9T51B0102	—	0.240	—	0.480	0.539	—	0.290	—
9T51B0122	0.180	—	0.360	—	—	0.410	—	0.230
9T51B0103	—	0.360	—	0.720	0.800	—	0.440	—
9T51B0123	0.270	—	0.540	—	—	0.610	—	0.350
9T51B0104	—	0.480	—	0.960	1.1	—	0.580	—
9T51B0124	0.360	—	0.720	—	—	0.820	—	0.460
9T51B0105	—	0.720	—	1.5	1.6	—	0.870	—
9T51B0125	0.540	—	1.1	—	—	1.3	—	0.690
9T51B0107	—	1.2	—	2.4	2.7	—	1.5	—
9T51B0127	0.900	—	1.8	—	—	2.1	—	1.2
9T51B0108	—	2.4	—	4.8	5.3	—	2.9	—
9T51B0128	1.8	—	3.6	—	—	4.1	—	2.3
9T51B0109	—	3.6	—	7.2	8.0	—	4.4	—
9T51B0129	2.7	—	5.4	—	—	6.1	—	3.5
9T51B0110	—	4.8	—	9.6	10.6	—	5.8	—
9T51B0130	3.6	—	7.2	—	—	8.2	—	4.6
9T51B0111	—	7.2	—	14.4	15.9	—	8.6	—
9T51B0131	5.4	—	10.8	—	—	12.2	—	6.9
9T51B0112	—	9.6	—	19.2	21.2	—	11.5	—
9T51B0132	7.2	—	14.4	—	—	16.3	—	9.2
9T51B0113	—	14.4	—	28.8	31.8	—	17.3	—
9T51B0133	10.8	—	21.6	—	—	24.4	—	13.7
9T21B1061G02	—	24.0	—	48.0	53.0	—	28.8	—
9T21B1037G02	—	24.0	—	48.0	53.0	—	28.8	—
9T21B1064G02	18.0	—	36.0	—	—	41.0	—	22.9
9T21B1040G02	18.0	—	36.0	—	—	41.0	—	22.9
Connection Diagram	C	C	D	D	D	D	C	C

¹The load kVA is the maximum load at voltages shown when transformers are connected as autotransformers according to the diagram referenced.

Table 4
120 Volts Output, 60 Hertz, Single-Phase

Product Number	Available Line Voltage							
	95	100	106	109	132	136	144	152
	Load kVA ¹							
9T51B0102	—	0.250	—	0.500	0.550	—	0.300	—
9T51B0122	0.190	—	0.380	—	—	0.430	—	0.240
9T51B0103	—	0.380	—	0.750	0.830	—	0.450	—
9T51B0123	0.290	—	0.570	—	—	0.640	—	0.360
9T51B0104	—	0.500	—	1.0	1.1	—	0.600	—
9T51B0124	0.380	—	0.750	—	—	0.850	—	0.480
9T51B0105	—	0.750	—	1.5	1.7	—	0.900	—
9T51B0125	0.570	—	1.2	—	—	1.3	—	0.720
9T51B0107	—	1.3	—	2.5	2.8	—	1.5	—
9T51B0127	0.940	—	1.9	—	—	2.2	—	1.2
9T51B0108	—	2.5	—	5.0	5.5	—	3.0	—
9T51B0128	1.9	—	3.8	—	—	4.3	—	2.4
9T51B0109	—	3.8	—	7.5	8.3	—	4.5	—
9T51B0129	2.9	—	5.7	—	—	6.4	—	3.6
9T51B0110	—	5.0	—	10.0	11.0	—	6.0	—
9T51B0130	3.8	—	7.5	—	—	8.5	—	4.8
9T51B0111	—	7.5	—	15.0	16.5	—	9.0	—
9T51B0131	5.7	—	11.3	—	—	12.8	—	7.2
9T51B0112	—	10.0	—	20.0	22.0	—	12.0	—
9T51B0132	7.5	—	15.0	—	—	17.0	—	9.5
9T51B0113	—	15.0	—	30.0	33.0	—	18.0	—
9T51B0133	11.3	—	22.5	—	—	25.5	—	14.3
9T21B1061G02	—	25.0	—	50.0	55.0	—	30.0	—
9T21B1037G02	—	25.0	—	50.0	55.0	—	30.0	—
9T21B1064G02	18.8	—	38.0	—	—	43.0	—	23.8
9T21B1040G02	18.8	—	38.0	—	—	43.0	—	23.8
Connection Diagram	C	C	D	D	D	D	C	C

¹The load kVA is the maximum load at voltages shown when transformers are connected as autotransformers according to the diagram referenced.



Dry Type Transformers Buck-Boost Selection Tables Encapsulated For Bucking and Boosting Voltage

Table 5
230 Volts, 3-Wire Output, 60 Hertz, Three-Phase²

Quantity Required Per Bank	Product Number	Available Line Voltage				
		181Y/105	192Y/111	203Y/117	208Y/120	277Y/160
		Load kVA ¹				
3	9T51B0102	—	0.830	—	1.7	—
3	9T51B0122	0.620	—	1.3	—	—
3	9T51B0202	—	—	—	—	0.480
3	9T51B0103	—	1.2	—	2.5	—
3	9T51B0123	0.930	—	1.9	—	—
3	9T51B0203	—	—	—	—	0.720
3	9T51B0104	—	1.7	—	3.4	—
3	9T51B0124	1.2	—	2.5	—	—
3	9T51B0204	—	—	—	—	0.960
3	9T51B0105	—	2.5	—	5.0	—
3	9T51B0125	1.9	—	3.7	—	—
3	9T51B0205	—	—	—	—	1.44
3	9T51B0107	—	4.2	—	8.3	—
3	9T51B0127	3.1	—	6.2	—	—
3	9T51B0207	—	—	—	—	2.4
3	9T51B0108	—	8.3	—	16.6	—
3	9T51B0128	6.2	—	12.5	—	—
3	9T51B0208	—	—	—	—	4.8
3	9T51B0109	—	12.5	—	25.0	—
3	9T51B0129	9.3	—	18.7	—	—
3	9T51B0209	—	—	—	—	7.2
3	9T51B0110	—	16.6	—	33.2	—
3	9T51B0130	12.5	—	25.0	—	—
3	9T51B0210	—	—	—	—	9.6
3	9T51B0111	—	25.0	—	50.0	—
3	9T51B0131	18.7	—	37.0	—	—
3	9T51B0211	—	—	—	—	14.4
3	9T51B0112	—	33.0	—	66.0	—
3	9T51B0132	25.0	—	50.0	—	—
3	9T51B0212	—	—	—	—	19.2
3	9T51B0113	—	50.0	—	100.0	—
3	9T51B0133	37.5	—	75.0	—	—
3	9T51B0213	—	—	—	—	28.8
3	9T21B1037G02	—	83.0	—	167.0	—
3	9T21B1040G02	62.0	—	125.0	—	—
Connection Diagram Page 10-61		F	F	G	G	F

¹The load kVA is the maximum load at voltages shown when transformers are connected as autotransformers according to the diagram referenced.

²See Caution page 10-59, footnote 1.



Dry Type Transformers Buck-Boost Selection Tables Encapsulated For Bucking and Boosting Voltage

Section 10

Table 6
240 Volts, 3-Wire Output, 60 Hertz, Three-Phase²

Quantity Required Per Bank	Product Number	Available Line Voltage				
		189V/109	200V/115	208V/120 ³ 212V/122	218V/126	288V/166
		Load kVA ¹				
3	9T51B0102	—	0.870	—	1.7	—
3	9T51B0122	0.650	—	1.3	—	—
3	9T51B0202	—	—	—	—	0.500
3	9T51B0103	—	1.3	—	2.6	—
3	9T51B0123	0.970	—	2.0	—	—
3	9T51B0203	—	—	—	—	0.750
3	9T51B0104	—	1.7	—	3.5	—
3	9T51B0124	1.3	—	2.6	—	—
3	9T51B0204	—	—	—	—	1.0
3	9T51B0105	—	2.6	—	5.2	—
3	9T51B0125	2.0	—	3.9	—	—
3	9T51B0205	—	—	—	—	1.5
3	9T51B0107	—	4.3	—	8.7	—
3	9T51B0127	3.2	—	6.5	—	—
3	9T51B0207	—	—	—	—	2.5
3	9T51B0108	—	8.7	—	17.3	—
3	9T51B0128	6.5	—	13.0	—	—
3	9T51B0208	—	—	—	—	5.0
3	9T51B0109	—	13.0	—	26.0	—
3	9T51B0129	9.7	—	19.5	—	—
3	9T51B0209	—	—	—	—	7.5
3	9T51B0110	—	17.3	—	34.6	—
3	9T51B0130	13.0	—	26.0	—	—
3	9T51B0210	—	—	—	—	10.0
3	9T51B0111	—	26.0	—	52.0	—
3	9T51B0131	19.5	—	39.0	—	—
3	9T51B0211	—	—	—	—	15.0
3	9T51B0112	—	35.0	—	70.0	—
3	9T51B0132	26.0	—	52.0	—	—
3	9T51B0212	—	—	—	—	20.0
3	9T51B0113	—	52.0	—	104.0	—
3	9T51B0133	39.0	—	78.0	—	—
3	9T51B0213	—	—	—	—	30.0
3	9T21B1037G02	—	87.0	—	173.0	—
3	9T21B1040G02	65.0	—	130.0	—	—
Connection Diagram Page 10-61		F	F	G	G	F

¹The load kVA is the maximum load at voltages shown when transformers are connected as autotransformers according to the diagram referenced.

²See Caution page 10-59, footnote 1.

³When 208V/120 Volts is the available line voltage, the 212V/122 column may be used to obtain 236 Volts which should be satisfactory for most applications.



Dry Type Transformers Buck-Boost Selection Tables Encapsulated For Bucking and Boosting Voltage

Table 7

460 Volts, 3-Wire Output, 60 Hertz, Three-Phase¹

Quantity Required Per Bank	Product Number	Available Line Voltage — 3- or 4-Wire				
		385	406	418	432	438
		Load kVA ²				
3	9T51B0102	—	—	1.66	—	3.32
3	9T51B0122	—	1.25	—	2.49	—
3	9T51B0202	0.830	—	—	—	—
3	9T51B0103	—	—	2.48	—	4.96
3	9T51B0123	—	1.87	—	3.73	—
3	9T51B0203	1.2	—	—	—	—
3	9T51B0104	—	—	3.31	—	6.62
3	9T51B0124	—	2.49	—	4.97	—
3	9T51B0204	1.7	—	—	—	—
3	9T51B0105	—	—	4.97	—	9.94
3	9T51B0125	—	3.73	—	3.9	—
3	9T51B0205	2.5	—	—	—	—
3	9T51B0107	—	—	8.28	—	16.6
3	9T51B0127	—	6.22	—	6.5	—
3	9T51B0207	4.2	—	—	—	—
3	9T51B0108	—	—	16.6	—	33.2
3	9T51B0128	—	12.5	—	13.0	—
3	9T51B0208	8.3	—	—	—	—
3	9T51B0109	—	—	24.8	—	59.6
3	9T51B0129	—	18.7	—	19.5	—
3	9T51B0209	12.5	—	—	—	—
3	9T51B0110	—	—	33.1	—	66.2
3	9T51B0130	—	24.9	—	26.0	—
3	9T51B0210	16.6	—	—	—	—
3	9T51B0111	—	—	49.7	—	99.4
3	9T51B0131	—	37.3	—	39.0	—
3	9T51B0211	24.9	—	—	—	—
3	9T51B0112	—	—	66.3	—	133.0
3	9T51B0132	—	49.7	—	52.0	—
3	9T51B0212	33.2	—	—	—	—
3	9T51B0113	—	—	99.3	—	198.6
3	9T51B0133	—	74.6	—	78.0	—
3	9T51B0213	49.8	—	—	—	—
3	9T21B1037G02	—	—	166.0	—	322.0
3	9T21B1040G02	—	125.0	—	130.0	—
Connection Diagram Page 10-61		F	H	H	I	I

¹Caution: If input is 3-wire Delta or 4-wire midtapped Delta, the neutral established from the bank of buck-boost transformers must be insulated and isolated from the input power neutral and/or ground.

²The load kVA is the maximum load at voltages shown when transformers are connected as autotransformers according to the diagram referenced.



Dry Type Transformers Buck-Boost Selection Tables Encapsulated For Bucking and Boosting Voltage

Section 10

Table 8

480 Volts, 3-Wire Output, 60 Hertz, Three-Phase¹

Quantity Required Per Bank	Product Number	Available Line Voltage — 3- or 4-Wire			
		400	424	436	450
		Load kVA ²			
	9T51B0102	—	—	1.74	—
3	9T51B0122	—	1.3	—	2.6
3	9T51B0202	0.866	—	—	—
3	9T51B0103	—	—	2.6	—
3	9T51B0123	—	1.95	—	3.9
3	9T51B0203	1.3	—	—	—
3	9T51B0104	—	—	3.5	—
3	9T51B0124	—	2.6	—	5.2
3	9T51B0204	1.7	—	—	—
3	9T51B0105	—	—	5.2	—
3	9T51B0125	—	3.9	—	7.8
3	9T51B0205	2.6	—	—	—
3	9T51B0107	—	—	8.7	—
3	9T51B0127	—	6.3	—	13.0
3	9T51B0207	4.3	—	—	—
3	9T51B0108	—	—	17.4	—
3	9T51B0128	—	13.0	—	26.0
3	9T51B0208	8.7	—	—	—
3	9T51B0109	—	—	26.0	—
3	9T51B0129	—	19.5	—	39.0
3	9T51B0209	13.0	—	—	—
3	9T51B0110	—	—	35.0	—
3	9T51B0130	—	26.0	—	52.0
3	9T51B0210	17.3	—	—	—
3	9T51B0111	—	—	52.2	—
3	9T51B0131	—	39.0	—	78.0
3	9T51B0211	26.0	—	—	—
3	9T51B0112	—	—	69.0	—
3	9T51B0132	—	52.0	—	104.0
3	9T51B0212	34.6	—	—	—
3	9T51B0113	—	—	104.0	—
3	9T51B0133	—	78.0	—	156.0
3	9T51B0213	51.9	—	—	—
3	9T21B1037G02	—	—	174.0	—
3	9T21B1040G02	—	130.0	—	260.0
	Connection Diagram Page 10-61	F	H	H	I

Table 9

208 Volts, 3-Wire, 60 Hertz, Three-Phase¹

Quantity Required Per Bank	Product Number	Available Line Voltage — 3- or 4-Wire			
		218	222	229	236
		Load kVA ²			
2	9T51B0102	1.6	—	0.800	—
2	9T51B0122	—	1.2	—	0.640
2	9T51B0103	2.3	—	1.2	—
2	9T51B0123	—	1.8	—	0.960
2	9T51B0104	3.2	—	1.6	—
2	9T51B0124	—	2.4	—	1.3
2	9T51B0105	4.7	—	2.5	—
2	9T51B0125	—	3.6	—	1.9
2	9T51B0107	7.8	—	4.1	—
2	9T51B0127	—	6.0	—	3.2
2	9T51B0108	16	—	8.0	—
2	9T51B0128	—	12.0	—	6.4
2	9T51B0109	23.6	—	12.4	—
2	9T51B0129	—	18.0	—	9.6
2	9T51B0110	31.5	—	16.5	—
2	9T51B0130	—	24.0	—	12.7
2	9T51B0111	47.5	—	24.8	—
2	9T51B0131	—	36.0	—	19.1
2	9T51B0112	63.0	—	33.0	—
2	9T51B0132	—	48.0	—	25.6
2	9T51B0113	94	—	49.6	—
2	9T51B0133	—	72.0	—	38.3
	Connection Diagram Page 10-61	J	J	Z	Z

¹Caution: If input is 3-wire Delta or 4-wire midtapped Delta, the neutral established from the bank of buck-boost transformers must be insulated and isolated from the input power neutral and/or ground.

²The load kVA is the maximum load at voltages shown when transformers are connected as autotransformers according to the diagram referenced.



Dry Type Transformers

Buck-Boost Connection Diagrams

Encapsulated

For Bucking and Boosting Voltage

Connection Diagrams

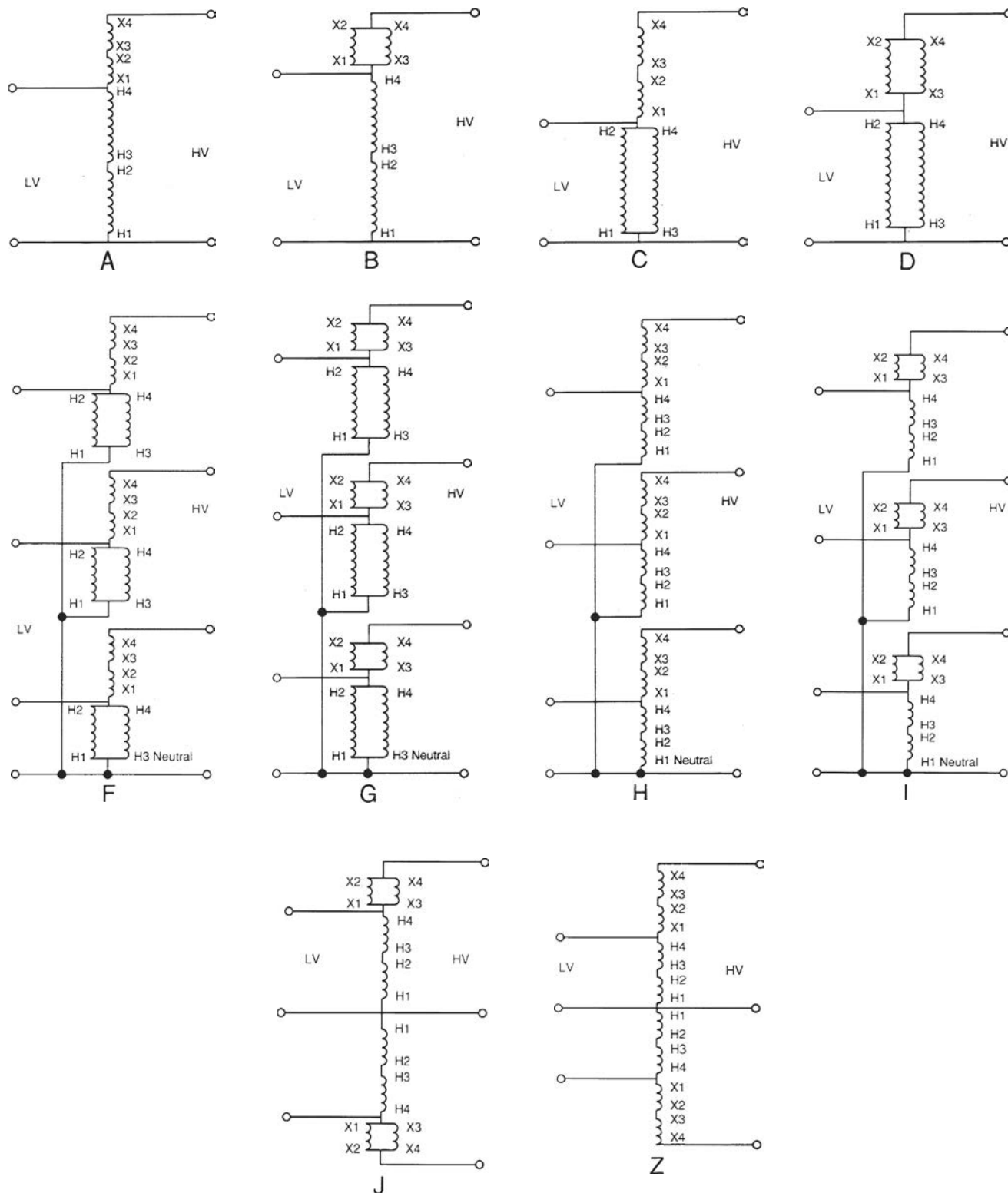

Dry Type Transformers

Open Core and Coil Transformers

Machine Tool and Control Power

Product Description

Core and coil transformers for machine tools are used to provide voltage to control devices in applications where regulation and minimum space are important. Welded cores provide the highest quality electrical performance and quiet operation.

Standards: Type IP transformers conform to NEMA ST20

Listings: UL listed under UL-5085, File E2739
CSA Certified under C22.2, Number 66, File 3272

Insulation Classes: 150VA and below: 105°C insulation class, 55°C Rise

200VA and above: 185°C (NEMA)

180°C (UL) insulation class, 115°C Rise

Frequency: 60 Hz standard; 50 Hz optional.

Voltage Regulation: All designs 2.0 kVA and below are compensated for voltage drop. Compensation ranges from 10% in the smallest rating to 3% for the largest. All machine tool designs meet or exceed NMTBA regulation requirements.

Series-Multiple Secondary Connections: Transformers with 120/240 V secondaries (series-multiple) may be connected for 120 V, 240 V or 240/120 V three-wire. Jumpers are provided.

Overcurrent Protection: Type IP transformers are low impedance transformers that require overcurrent protection for most applications. They provide for optional integral primary and/or secondary fusing.

Mounting Dimensions: Type IP transformers are lightweight, small, and designed for minimum mounting dimensions. Many units will fit competitors mounting footprints.



Core and Coil Transformer
Terminal Board Connection



Core and Coil Transformer
Leads Out Connection

Advantages

- Finger-safe terminals offer added protection and safety
- Pressure plate terminals ensure secure connections
- Wide variety of fusing options

Key Features—Terminal Board Connection

- Rugged, high-impact plastic terminal board
- Full head #8 brass screws assure quick, easy terminations with maximum connection integrity
- Copper windings
- Flexible design allows input or output voltage to match any application
- CUL, CE, UL approvals
- Available fuse-blocks offer simple, low-cost fusing



Dry Type Transformers Open Core and Coil Transformers Machine Tool Applications Single-Phase, Fully-encapsulated Design

Section 10

60 Hz Terminal Board Connection

Input Voltage	Output Voltage	kVA	Wiring Diagram No. ¹	Approx. Net Weight (Lbs)	Frame Size	Product Number
220x440, 230x460,240x480 Volts	110, 115, 120 Volts	0.05	1	2.4	6100	9T58K0042
220x440, 230x460,240x480 Volts	110, 115, 120 Volts	0.08	1	2.8	6125	9T58K0043
220x440, 230x460,240x480 Volts	110, 115, 120 Volts	0.10	1	3.6	8100	9T58K0044
220x440, 230x460,240x480 Volts	110, 115, 120 Volts	0.15	1	5.1	8150	9T58K0045
220x440, 230x460,240x480 Volts	110, 115, 120 Volts	0.20	1	5.8	8175	9T58K0046
220x440, 230x460,240x480 Volts	110, 115, 120 Volts	0.25	1	6.5	8200	9T58K0047
220x440, 230x460,240x480 Volts	110, 115, 120 Volts	0.30	1	7.6	8250	9T58K0048
220x440, 230x460,240x480 Volts	110, 115, 120 Volts	0.38	1	7.6	8250	9T58K0049
220x440, 230x460,240x480 Volts	110, 115, 120 Volts	0.50	1	10.7	10225	9T58K0050
220x440, 230x460,240x480 Volts	110, 115, 120 Volts	0.75	1	12	12225	9T58K0051
220x440, 230x460,240x480 Volts	110, 115, 120 Volts	1	1	16.1	12300	9T58K0052
220x440, 230x460,240x480 Volts	110, 115, 120 Volts	2	1	26.7	14225	9T58K0053
220x440, 230x460,240x480 Volts	110, 115, 120 Volts	2	1	32.7	14300	9T58K0054
220x440, 230x460,240x480 Volts	110, 115, 120 Volts	3	1	47.4	14475	9T58K0055

50/60 Hz Terminal Board Connection

Input Voltage	Output Voltage	kVA	Wiring Diagram No. ¹	Approx. Net Weight (Lbs)	Frame Size	Product Number
230/460/575 Volts	115/95 Volts	0.05	2	3.1	6150	9T58K0062
230/460/575 Volts	115/95 Volts	0.08	2	3.6	8100	9T58K0063
230/460/575 Volts	115/95 Volts	0.10	2	5.1	8150	9T58K0064
230/460/575 Volts	115/95 Volts	0.15	2	6.5	8200	9T58K0065
230/460/575 Volts	115/95 Volts	0.20	2	6.5	8200	9T58K0066
230/460/575 Volts	115/95 Volts	0.25	2	7.6	8250	9T58K0067
230/460/575 Volts	115/95 Volts	0.30	2	10.7	10225	9T58K0068
230/460/575 Volts	115/95 Volts	0.38	2	10.7	10225	9T58K0069
230/460/575 Volts	115/95 Volts	0.50	2	10.7	10225	9T58K0070
230/460/575 Volts	115/95 Volts	0.75	2	16.1	12300	9T58K0071
230/460/575 Volts	115/95 Volts	1	2	26.7	14225	9T58K0072
230/460/575 Volts	115/95 Volts	1.5	2	32.7	14300	9T58K0073
230/460/575 Volts	115/95 Volts	2	2	47.4	14475	9T58K0074
208/277/380 Volts	115/95 Volts	0.05	3	3.1	6150	9T58K0082
208/277/380 Volts	115/95 Volts	0.08	3	3.6	8100	9T58K0083
208/277/380 Volts	115/95 Volts	0.10	3	5.1	8150	9T58K0084
208/277/380 Volts	115/95 Volts	0.15	3	6.5	8200	9T58K0085
208/277/380 Volts	115/95 Volts	0.20	3	6.5	8200	9T58K0086
208/277/380 Volts	115/95 Volts	0.25	3	7.6	8250	9T58K0087
208/277/380 Volts	115/95 Volts	0.30	3	10.7	10225	9T58K0088
208/277/380 Volts	115/95 Volts	0.38	3	10.7	10225	9T58K0089
208/277/380 Volts	115/95 Volts	0.50	3	10.7	10225	9T58K0090
208/277/380 Volts	115/95 Volts	0.75	3	16.1	12300	9T58K0091
208/277/380 Volts	115/95 Volts	1	3	26.7	14225	9T58K0092
208/277/380 Volts	115/95 Volts	1.5	3	32.7	14300	9T58K0093
208/277/380 Volts	115/95 Volts	2	3	47.4	14475	9T58K0094

¹See page 10-67 for wiring diagrams.

Factory- or Field-Installed Options

Secondary Fusing—Factory- or field-installed secondary fuse clips are available. They are restricted to units with terminal strips and a single secondary voltage or secondary with one tap.

Dual Primary and Secondary Fusing—Factory- or field-installed dual primary and secondary fuse clips are available on all units.



Dry Type Transformers

Open Core and Coil Transformers

Control

Single-Phase, Fully-encapsulated Design

Section 10

60 Hz Terminal Board Connection

Input Voltage	Output Voltage	kVA	Wiring Diagram No. ¹	Approx. Net Weight (Lbs)	Frame Size	Product Number
240x480 Volts	120/240 Volts	0.05	4	2.4	6100	9T58K2802
240x480 Volts	120/240 Volts	0.08	4	2.8	6125	9T58K2803
240x480 Volts	120/240 Volts	0.10	4	3.6	8100	9T58K2804
240x480 Volts	120/240 Volts	0.15	4	5.1	8150	9T58K2805
240x480 Volts	120/240 Volts	0.20	4	5.8	8175	9T58K2806
240x480 Volts	120/240 Volts	0.25	4	6.5	8200	9T58K2807
240x480 Volts	120/240 Volts	0.30	4	6.5	8200	9T58K2808
240x480 Volts	120/240 Volts	0.38	4	7.6	8250	9T58K2809
240x480 Volts	120/240 Volts	0.50	4	10.7	10225	9T58K2810
240x480 Volts	120/240 Volts	0.75	4	12	12225	9T58K2811
240x480 Volts	120/240 Volts	1	4	16.1	12300	9T58K2812
240x480 Volts	120/240 Volts	1.5	4	26.7	14225	9T58K2813
240x480 Volts	120/240 Volts	2	4	32.7	14300	9T58K2814
240x480 Volts	120/240 Volts	3	4	47.4	14475	9T58K2815
600 Volts	120/240 Volts	0.08	5	2.8	6125	9T58K2823
600 Volts	120/240 Volts	0.10	5	3.6	8100	9T58K2824
600 Volts	120/240 Volts	0.20	5	5.8	8175	9T58K2826
600 Volts	120/240 Volts	0.25	5	6.5	8200	9T58K2827
600 Volts	120/240 Volts	0.30	5	6.5	8200	9T58K2828
600 Volts	120/240 Volts	0.50	5	10.7	10225	9T58K2830
600 Volts	120/240 Volts	0.75	5	12	12225	9T58K2831
600 Volts	120/240 Volts	1	5	16.1	12300	9T58K2832
600 Volts	120/240 Volts	1.5	5	26.7	14225	9T58K2833
600 Volts	120/240 Volts	2	5	32.7	14300	9T58K2834
600 Volts	120/240 Volts	3	5	47.4	14475	9T58K2835
120x240 Volts	120/240 Volts	0.10	6	3.6	8100	9T58K2907
120x240 Volts	120/240 Volts	0.20	6	5.8	8175	9T58K2909
120x240 Volts	120/240 Volts	0.30	6	6.5	8200	9T58K2911
120x240 Volts	120/240 Volts	0.50	6	10.7	10225	9T58K2913
120x240 Volts	120/240 Volts	0.75	6	12	12225	9T58K2914
120x240 Volts	120/240 Volts	1	6	16.1	12300	9T58K2915
120x240 Volts	120/240 Volts	2	6	32.7	14300	9T58K2917
120x240 Volts	120/240 Volts	3	6	47.4	14475	9T58K2918

60 Hz Terminal Board Connection

Input Voltage	Output Voltage	kVA	Wiring Diagram No. ¹	Approx. Net Weight (Lbs)	Frame Size	Product Number
120 x 240 Volts	12/24 Volts	0.05	7	2.4	6100	9T58K2873
120 x 240 Volts	12/24 Volts	0.075	7	2.8	6125	9T58K2874
120 x 240 Volts	12/24 Volts	0.10	7	3.6	8100	9T58K2875
120 x 240 Volts	12/24 Volts	0.15	7	5.1	8150	9T58K2876
120 x 240 Volts	12/24 Volts	0.20	7	5.8	8175	9T58K2877
120 x 240 Volts	12/24 Volts	0.25	7	6.5	8200	9T58K2878
120 x 240 Volts	12/24 Volts	0.30	7	6.5	8200	9T58K2879
240 x 480 Volts	12/24 Volts	0.25	---	6.5	8200	9T58K3024
240 x 480 Volts	12/24 Volts	0.05	---	2.4	6100	9T58K3164
240 x 480 Volts	12/24 Volts	0.10	---	3.6	8100	9T58K4132
240 x 480 Volts	12/24 Volts	0.15	---	5.1	8150	9T58K4133
208 x 240 Volts	12/24 Volts	0.05	---	2.4	6100	9T58K4050
208 x 240 Volts	12/24 Volts	0.10	---	3.6	8100	9T58K4051
208 x 240 Volts	12/24 Volts	0.15	---	5.1	8150	9T58K4052
208 x 240 Volts	12/24 Volts	0.25	---	6.5	8200	9T58K4053

50/60 Hz Terminal Board Connection

Input Voltage	Output Voltage	kVA	Wiring Diagram No. ¹	Approx. Net Weight (Lbs)	Frame Size	Product Number
240 x 480 Volts	120/240 Volts	0.50	4	10.7	10225	9T58K2930
240 x 480 Volts	120/240 Volts	0.75	4	16.1	12300	9T58K2931
240 x 480 Volts	120/240 Volts	1	4	26.7	14225	9T58K2932
240 x 480 Volts	120/240 Volts	1.5	4	32.7	14300	9T58K2933
240 x 480 Volts	120/240 Volts	2	4	47.4	14475	9T58K2934
240 x 480 Volts	120/240 Volts	3	4	47.4	14475	9T58K2935
380/400/416 Volts	115/230 Volts	0.25	8	6.5	8200	9T58K2975
380/400/416 Volts	115/230 Volts	0.50	8	10.7	10225	9T58K2978
380/400/416 Volts	115/230 Volts	0.75	8	16.1	12300	9T58K2979
380/400/416 Volts	115/230 Volts	1	8	26.7	14225	9T58K2980
380/400/416 Volts	115/230 Volts	1.5	8	32.7	14300	9T58K2981
380/400/416 Volts	115/230 Volts	2	8	47.4	14475	9T58K2982
380/400/416 Volts	115/230 Volts	3	8	47.4	14475	9T58K2983

¹See page 10-67 for wiring diagrams.

²Secondary fusing not available.



Dry Type Transformers

Open Core and Coil Transformers

Control

Section 10

Single-Phase, Fully-encapsulated Design

60 Hz Leads Out Connection²

Input Voltage	Output Voltage	kVA	Wiring Diagram No. ¹	Approx. Net Weight (Lbs)	Frame Size	Product Number
120x240 Volts	12/24 Volts	0.05	7	2.4	6100	9T58K1873G07
120x240 Volts	12/24 Volts	0.075	7	2.8	6125	9T58K1874G07
120x240 Volts	12/24 Volts	0.10	7	3.6	8100	9T58K1875G07
120x240 Volts	12/24 Volts	0.15	7	5.1	8150	9T58K1876G07
120x240 Volts	12/24 Volts	0.20	7	5.8	8175	9T58K1877G07
120x240 Volts	12/24 Volts	0.25	7	6.5	8200	9T58K1878G07
120x240 Volts	12/24 Volts	0.30	7	6.5	8200	9T58K1879G07
120x240 Volts	12/24 Volts	0.50	7	10.7	10225	9T58K1881G07
120x240 Volts	12/24 Volts	0.75	7	12	12225	9T58K1882G07
120x240 Volts	12/24 Volts	1	7	26.7	14225	9T58K1883G07

60 Hz Leads Out Connection²

Input Voltage	Output Voltage	kVA	Wiring Diagram No. ¹	Approx. Net Weight (Lbs)	Frame Size	Product Number
240 x 480 Volts	120/240 Volts	0.05	4	2.4	6100	9T58K1802G07
240 x 480 Volts	120/240 Volts	0.075	4	2.8	6125	9T58K1803G07
240 x 480 Volts	120/240 Volts	0.10	4	3.6	8100	9T58K1804G07
240 x 480 Volts	120/240 Volts	0.15	4	5.1	8150	9T58K1805G07
240 x 480 Volts	120/240 Volts	0.20	4	5.8	8175	9T58K1806G07
240 x 480 Volts	120/240 Volts	0.25	4	6.5	8200	9T58K1807G07
240 x 480 Volts	120/240 Volts	0.30	4	6.5	8200	9T58K1808G07
240 x 480 Volts	120/240 Volts	0.375	4	7.6	8250	9T58K1809G07
240 x 480 Volts	120/240 Volts	0.50	4	10.7	10225	9T58K1810G07
240 x 480 Volts	120/240 Volts	0.75	4	12	12225	9T58K1811G07
240 x 480 Volts	120/240 Volts	1	4	16.1	12300	9T58K1812G07
240 x 480 Volts	120/240 Volts	1.5	4	26.7	14225	9T58K1813G07
240 x 480 Volts	120/240 Volts	2	4	32.7	14300	9T58K1814G07
240 x 480 Volts	120/240 Volts	3	4	47.4	14475	9T58K1815G07
600 Volts	120/240 Volts	0.10	5	3.6	8100	9T58K1824G07
600 Volts	120/240 Volts	0.20	5	5.8	8175	9T58K1826G07
600 Volts	120/240 Volts	0.30	5	6.5	8200	9T58K1828G07
600 Volts	120/240 Volts	0.50	5	10.7	10225	9T58K1830G07
600 Volts	120/240 Volts	1	5	26.7	14225	9T58K1832G07
600 Volts	120/240 Volts	2	5	32.7	14300	9T58K1834G07
600 Volts	120/240 Volts	3	5	47.4	14475	9T58K1835G07

50/60 Hz Leads Out Connection²

Input Voltage	Output Voltage	kVA	Wiring Diagram No. ¹	Approx. Net Weight (Lbs)	Frame Size	Product Number
240x480 Volts	120/240 Volts	0.25	4	6.5	8200	9T58K1927G07
240x480 Volts	120/240 Volts	0.30	4	7.6	8250	9T58K1928G07
240x480 Volts	120/240 Volts	0.50	4	10.7	10225	9T58K1930G07
240x480 Volts	120/240 Volts	0.75	4	16.1	12300	9T58K1931G07
240x480 Volts	120/240 Volts	1.5	4	32.7	14300	9T58K1933G07
240x480 Volts	120/240 Volts	3	4	47.4	14475	9T58K1935G07
380/400/416 Volts	115/230 Volts	0.50	8	10.7	10225	9T58K1978G07
380/400/416 Volts	115/230 Volts	0.75	8	16.1	12300	9T58K1979G07
380/400/416 Volts	115/230 Volts	1	8	26.7	14225	9T58K1980G07
380/400/416 Volts	115/230 Volts	1.5	8	32.7	14300	9T58K1981G07

¹See page 10-67 for wiring diagrams.

²Secondary fusing not available.

50/60 Hz Universal Voltage/Multitap Terminal Strip Connection

kVA	Frame Size	Product Number
0.25	10225	9T58K3715
0.35	10225	9T58K3716
0.50	12225	9T58K3717
0.75	12300	9T58K3718
1	14225	9T58K3719
1.5	14300	9T58K3720
2	14475	9T58K3721

Voltage Table

Incoming Voltage				Output Voltage		
H1 H2	H1 H3	H1 H4	H1 H5	X1 X2	X1 X3	X1 X4
208			500	85	100	110
		415		86	104	113
220	380	440	550	91	110	120
230	40	460	575	95	115	125
240	416	480	600	99	120	130



Dry Type Transformers Open Core and Coil Transformers Options and Fusing Guide

Section 10

Transformer Fusing Options

Accessory Description	Product Number	Accessory Description	Product Number
(1) Quarter-Inch Fuseholder	9T58K0000G24	(2) CC + (1) Quarter-Inch Fuseholder	9T58K0000G48
(1) Midget Fuseholder	9T58K0000G42	(2) CC + (1) Midget Fuseholder	9T58K0000G38
(1) H/K Fuseholder	9T58K0000G10	(2) CC + (1) H/K Fuseholder	9T58K0000G18
(2) CC Fuseholder	9T58K0000G43	(2) CC Fuseholder	9T58E0000G46
(2) H/K Fuseholder	9T58K0000G05	(2) CC + (1) Midget Fuseholder	9T58E0000G47
		Jumper Links	9T58K0000G01

Fuse Guide

Midget Class CC Rejection Fuse

Primary Voltage	Transformer Continuous Power Rating (VA)								
	50	75	100	150	200	250	300	375	500
	Fuse Rating (Amperes)								
100	1.50	2.00	3.00	4.00	3.00	4.00	5.00	6.00	8.00
110	1.25	2.00	2.50	4.00	5.00	3.00	4.00	5.00	7.00
120	1.25	1.60	2.50	3.00	5.00	3.00	4.00	5.00	6.00
200	0.75	1.00	1.50	2.00	3.00	3.00	4.00	5.00	4.00
208	0.60	1.00	1.25	2.00	2.50	3.00	4.00	5.00	4.00
220	0.60	1.00	1.25	2.00	2.50	3.00	4.00	5.00	3.00
230	0.60	0.80	1.25	1.60	2.50	3.00	3.00	4.00	3.00
240	0.60	0.80	1.25	1.60	2.50	3.00	3.00	4.00	3.00
277	0.50	0.80	1.00	1.60	2.00	2.50	3.00	4.00	5.00
380	0.30	0.50	0.75	1.00	1.50	1.60	2.00	2.50	3.00
400	0.30	0.50	0.75	1.00	1.50	1.60	2.00	2.50	3.00
416	0.30	0.50	0.60	1.00	1.25	1.60	2.00	2.50	3.00
440	0.30	0.50	0.60	1.00	1.25	1.60	2.00	2.50	3.00
460	0.30	0.40	0.60	0.80	1.25	1.60	1.60	2.00	3.00
480	0.30	0.40	0.60	0.80	1.25	1.50	1.60	2.00	3.00
550	0.25	0.40	0.50	0.80	1.00	1.25	1.60	2.00	2.50
575	0.25	0.30	0.50	0.75	1.00	1.25	1.50	1.60	2.50
600	0.25	0.30	0.50	0.75	1.00	1.25	1.50	1.60	2.50

For motor control circuits fusing, refer to NEC 430-72.

Secondary Fuse Selection

Glass Fuse

Secondary Voltage	Transformer Continuous Power Rating (VA)													
	50	75	100	150	200	250	300	375	500	750	1000	1500	2000	3000
	Fuse Rating (Amperes)													
12	6.00	10.00	12.00	15.00	20.00	25.00	30.00	—	—	—	—	—	—	—
24	3.00	5.00	6.00	10.00	12.00	12.00	15.00	—	25.00	—	—	—	—	—
36	2.00	3.00	4.00	6.00	8.00	10.00	12.00	—	15.00	—	—	—	—	—
48	1.50	2.50	3.00	5.00	6.00	8.00	10.00	12.00	12.00	—	—	—	—	—
95	0.80	1.25	1.60	2.50	3.00	4.00	5.00	6.00	8.00	12.00	15.00	20.00	25.00	—
110	0.75	1.00	1.50	2.00	3.00	3.00	4.00	5.00	7.00	10.00	12.00	20.00	25.00	30.00
115	0.60	1.00	1.25	2.00	2.50	3.00	4.00	5.00	7.00	10.00	12.00	20.00	20.00	30.00
120	0.60	1.00	1.25	2.00	2.50	3.00	4.00	5.00	6.00	10.00	12.00	15.00	20.00	30.00
208	0.40	0.60	0.80	1.00	1.60	2.00	2.00	3.00	4.00	6.00	8.00	12.00	15.00	20.00
220	0.30	0.50	0.75	1.00	1.50	1.60	2.00	2.50	3.00	5.00	7.00	10.00	12.00	20.00
230	0.30	0.50	0.60	1.00	1.25	1.60	2.00	2.50	3.00	5.00	7.00	10.00	12.00	20.00
240	0.30	0.50	0.60	1.00	1.25	1.60	2.00	2.50	3.00	5.00	6.00	10.00	12.00	15.00



Dry Type Transformers

Open Core and Coil Transformers

Machine Tool Applications

Control
Wiring Diagrams

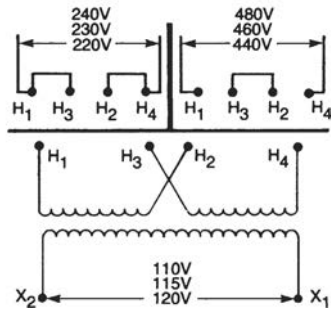

Diagram 1

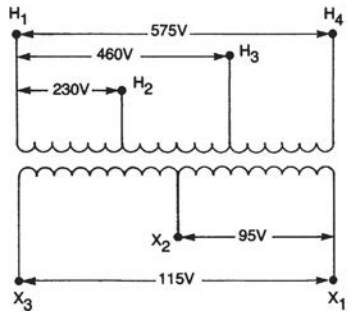

Diagram 2

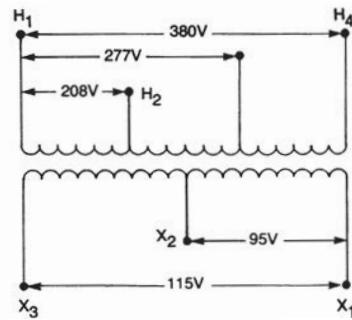

Diagram 3

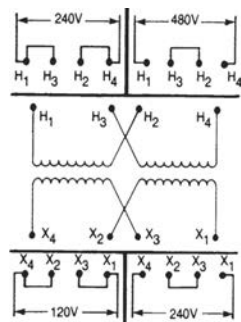

Diagram 4

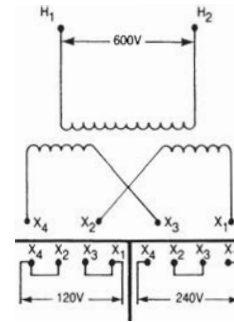

Diagram 5

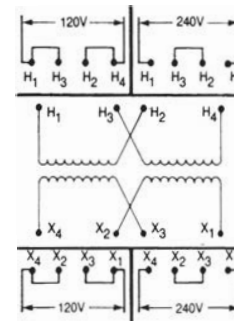

Diagram 6

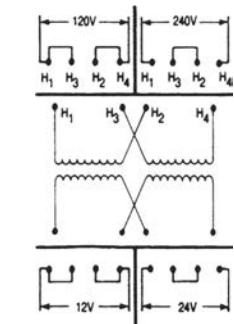

Diagram 7

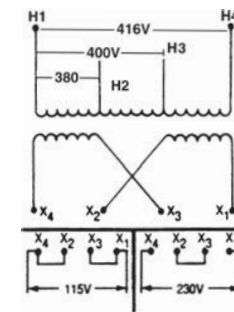

Diagram 8



Dry Type Transformers

Open Core and Coil Transformers

Outlines and Dimensions

6, 8, 10, 12 and 14 Frames

Section 10

Terminal Board and Leads Out Connection Style

Frame Size	Outline	Approx. Net Weight (Lbs.)	A Depth (in.)	B Width (in.)	C Height (in.)	E Mounting Depth (in.)	F Mounting Width (in.)	Mounting Slot (in.)
6100	303B957AA	2.4	3.75	3	2.65	2.16	2.5	.219x.750
6125	303B957AA	2.8	4	3	2.65	2.41	2.5	.219x.750
6150	303B957AA	3.1	4.25	3	2.65	2.66	2.5	.219x.750
8100	303B957CA	3.6	4	3.75	3.28	2.16	3.13	.219x.750
8150	303B957CA	5.1	4.5	3.75	3.28	2.66	3.13	.219x.750
8175	303B957CA	5.8	4.75	3.75	3.28	2.91	3.13	.219x.750
8200	303B957CA	6.5	5	3.75	3.28	3.16	3.13	.219x.750
8250	303B957CA	7.6	5.5	3.75	3.28	3.66	3.13	.219x.750
10225	303B957EA	10.7	5.62	4.5	3.9	3.38	3.75	.297x.580
12225	303B957GA	12	5.88	5.25	4.53	3.38	4	.297x.580
12300	303B957GA	16.1	6.62	5.25	4.53	4.12	4	.297x.580
14225	303B957JA	26.7	6.5	6.75	5.78	3.38	5.5	.297x.580
14300	303B957JA	32.7	7.25	6.75	5.78	4.12	5.5	.297x.580
14475	303B957JA	47.4	9	6.75	5.78	5.88	5.5	.297x.580

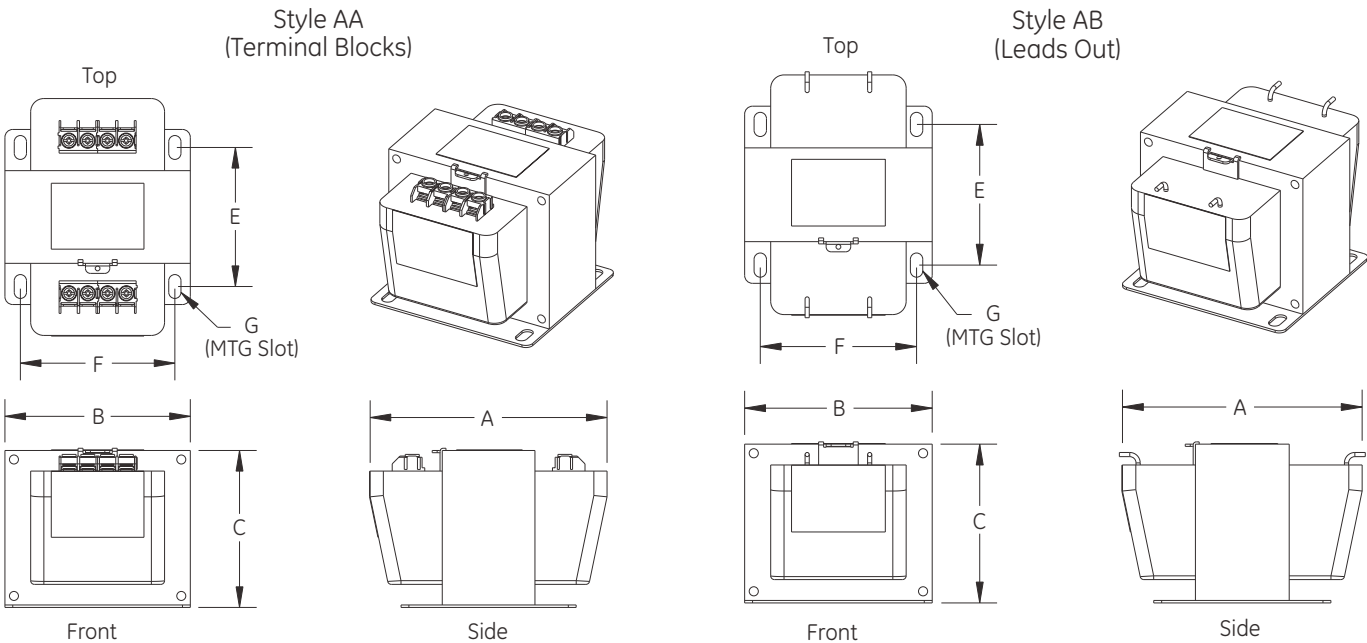

Dry Type Transformers

Open Core and Coil Transformers

CE-Rated

Application

This product is designed to be incorporated into equipment manufactured for sale in the European Community. This product is in conformity with the European Standard:

EN 60 742, 1995 per the provisions of the Low Voltage (LV) Directive 73/23/EEC in 1973 as amended by 93/68/EEC in 1995.

The Type "IP" CE offering utilizes all copper windings, which are encapsulated in a hardened epoxy, making the winding impervious to the elements. These designs are rated at 55° C rise with a 40° C ambient. Standard on these designs are terminal board covers. These provide added protection from current carrying terminals. These designs incorporate customer friendly connection on rugged high-impact molded terminal boards.

Besides being CE rated, these designs are both UL and C-UL listed.

50/60 Hz

Input Voltage	Output Voltage	kVA	Approx. Net Weight (Lbs)	Frame Size	Product Number
230/400 Volts	12/24 Volts	0.025	3	6100	9T58E0020
230/400 Volts	12/24 Volts	0.05	4	6150	9T58E0021
230/400 Volts	12/24 Volts	0.075	4	8100	9T58E0023
230/400 Volts	12/24 Volts	0.1	5	8150	9T58E0024
230/400 Volts	12/24 Volts	0.15	7	8200	9T58E0025
230/400 Volts	12/24 Volts	0.2	12	10225	9T58E0026
230/400 Volts	12/24 Volts	0.25	12	10225	9T58E0027
230/400 Volts	12/24 Volts	0.3	12	10225	9T58E0028
230/400 Volts	12/24 Volts	0.375	16	12225	9T58E0029
230/400 Volts	24/48 Volts	0.05	4	6150	9T58E0061
230/400 Volts	24/48 Volts	0.075	4	8100	9T58E0063
230/400 Volts	24/48 Volts	0.1	5	8150	9T58E0064
230/400 Volts	24/48 Volts	0.15	7	8200	9T58E0065
230/400 Volts	24/48 Volts	0.2	12	10225	9T58E0066
230/400 Volts	24/48 Volts	0.5	19	12300	9T58E0071
230/400 Volts	24/48 Volts	0.75	28	14225	9T58E0073
220/380, 230/400, 240/415 Volts	110/220, 115/230, 120/240 Volts	0.025	3	6100	9T58E0150
220/380, 230/400, 240/415 Volts	110/220, 115/230, 120/240 Volts	0.05	4	6150	9T58E0151
220/380, 230/400, 240/415 Volts	110/220, 115/230, 120/240 Volts	0.075	4	8100	9T58E0153
220/380, 230/400, 240/415 Volts	110/220, 115/230, 120/240 Volts	0.1	5	8150	9T58E0154
220/380, 230/400, 240/415 Volts	110/220, 115/230, 120/240 Volts	0.15	7	8200	9T58E0155
220/380, 230/400, 240/415 Volts	110/220, 115/230, 120/240 Volts	0.2	12	10225	9T58E0156
220/380, 230/400, 240/415 Volts	110/220, 115/230, 120/240 Volts	0.25	12	10225	9T58E0157
220/380, 230/400, 240/415 Volts	110/220, 115/230, 120/240 Volts	0.3	12	10225	9T58E0158
220/380, 230/400, 240/415 Volts	110/220, 115/230, 120/240 Volts	0.375	16	12225	9T58E0159
220/380, 230/400, 240/415 Volts	110/220, 115/230, 120/240 Volts	0.5	19	12300	9T58E0161
220/380, 230/400, 240/415 Volts	110/220, 115/230, 120/240 Volts	0.75	28	14225	9T58E0163
220/380, 230/400, 240/415 Volts	110/220, 115/230, 120/240 Volts	1	34	14300	9T58E0164
220/380, 230/400, 240/415 Volts	110/220, 115/230, 120/240 Volts	1.5	45	14475	9T58E0165

Factory- or Field-Installed Options

Available as an option are two fuse blocks that have fuse covers that provide the touch safety like the terminal blocks. These can be ordered factory-installed or as kits.

In kit form order:

Fuse block for 2 class CC fuses is 9T58E0000G46. Fuse block for 2 class CC and 1 Midget fuse is 9T58E0000G47.

For factory installation add the G46 or G47 suffix to the transformer product number (example 9T58E0020G47).



