

Solutions

Powered by Relationships.

Resolving issues that challenge you the most is the core of the way we do business. It is our job to understand your changing environment as well as the demands before you. Providing the right solution for the requirement is what sets us apart from those that focus on selling your products.

We strive to build a strong relationship by fulfilling your needs and delivering the right solution.

Distributed By:



www.minerallac.com

COM00002 | October 2016

CONTRACTOR CATALOG



Cully[™]



Minerallac[®]
Traditional



Black Claw[™]



IMPACT[®]
STAPLES



REDMORE[®]

CONTRACTOR CATALOG

Contact Us

Phone

Corporate Office
800-927-3293
8:00 A.M. to 5:00 P.M. CT

Regional Office
800-927-3293
8:00 A.M. to 5:00 P.M. PT

Mail

Corporate Office
100 Gast Road
Hampshire, IL 60140

Regional Office
Seattle, WA

Fax

Corporate Office
800-824-8942
Regional Office
206-789-9362

Online/Email

Web
www.minerallac.com
Customer Service
CustomerService@minerallac.com

WHY MINERALLAC?

Consolidation of our brands under one corporate umbrella provides a comprehensive package of hangers, fasteners, anchors and safety products. It also reinforces our mission to deliver time-sensitive and flexible service that maximizes the value of our trusted brands.

The Minerallac Company brands offer:

Minerallac Traditional® offers hangers, straps and beam clamps in more sizes and finishes than any other single source.

Cully™ offers one of the broadest lines of fasteners, anchors, tools and safety products for the industry.

Black Claw™ offers an expansive line of spring steel fasteners.

IMPACT Staples® offers residential and commercial staples.

Redmore® offers staples, nails as well as wire products for the utility market.

Minerallac Strut Fittings and Accessories offers an extensive line of nuts, clamps, fittings, brackets, rollers, hardware, concrete inserts, and post bases

and now...

Minerallac Stainless Steel offers a comprehensive catalog of stainless steel hardware, including: hangers, straps, clamps, nuts, washers, screws, bolts, anchors, couplings, and more in assorted grades of stainless steel.

This comprehensive assembly of products began in 1894 and continues today. This history, combined with our distributor partnerships has given us an understanding of your business and allowed us to address your specific needs in an effective and tangible way through relevant, meaningful solutions at cost-effective prices.

Partner with Minerallac and see why electrical distributors have trusted us with their business for over 120 years.



Quality Since 1894



Simple. Brilliant.

The new and improved Cully™ labels provide clear descriptions in an easy to read format while featuring vibrant colors. The labels have been transformed to make identifying fasteners on the rack or on the job site faster than before. It's also easier and more convenient to keep organized through small count quantities and stacking jar capabilities.

NEW FROM MINERALLAC

Minerallac is constantly evaluating our product lines to ensure that we provide the right product mix that electrical contractors need. To that end, Minerallac introduced two new product lines: Minerallac Strut Fittings and Accessories, and Minerallac Stainless Steel Fasteners. To learn more about these new product lines, please see their respective catalogs.

Minerallac[®] Strut Fittings



The new strut fittings and accessory line from Minerallac is made in America[†] and delivered with the Minerallac Advantage goal: 98% fill rate within 24 hours with ZERO errors.

Standard and specialty finishes include:

- 304 Stainless Steel
- 316 Stainless Steel
- Aluminum
- Hot-Dipped Galvanized
- Zinc Electroplate (EG)
- Yellow Chromate
- Powder Coated Green
- Epoxy
- Copper Chromate

Minerallac[®] STAINLESS STEEL



Looking for ways to increase worker safety and complete jobs that last? Take a look at the new Stainless Steel Hardware available from Minerallac.

- Strong
- Withstands harsh or corrosive environments and aggressive washdown
- Rust-resistant
- Poor electrical conductivity - safer for installation



Cully Pictorial Index

Pages 1–13

Screws

Pages 14–53

Grounding

Pages 54

Nuts/Washers

Pages 55–66

Bolts

Pages 67–75

Anchors

Pages 76–100

Hangers

Pages 101–110

Paints & Chemicals

Pages 111–129

Tools

Pages 130–165

Safety

Pages 166–176

Miscellaneous

Pages 177–183

Minerallac Pictorial Index

Pages 184–191

Minerallac Traditional

Pages 192–223

Black Claw

Pages 224–249

Dimension Charts

Pages 250–251

Impact Staples

Pages 252–257

Redmore

Pages 258–268

Displays

Pages 269–273

Numerical Index

Pages 274–285

Alphabetical Index

Pages 286–292

The following trademarks are the property of Minerallac Company.



Minerallac[®]
Company



Minerallac
Advantage[™]

Cully[™]

Minerallac[®]
Traditional

Black Claw[™]

IMPACT[®]
STAPLES

RENMORE[®]

Drive Stop, Min-E, Jiffy Clip, and graphic  icon design on the Impact Staples logo are also registered trademarks of Minerallac Company.

Minerallac Company holds patents on the following; Barbed Staples Pat. No. #D484,032, Saddle Retrofit for Bridal Rings Pat. No. #6,325,338.

All other trademarks identified in this catalog are the property of the particular supplier or vendor of that product. Minerallac Company has made every attempt to correctly identify these trademarks and at no time assumes to represent these as trademarks of their own.



Cully™

PICTORIAL INDEX

SHEET METAL SCREWS

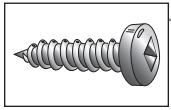

Pan Head, Sheet Metal Screw, Square
pages 14–16

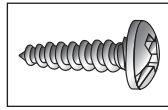

Pan Head, Sheet Metal Screw, Phillips/Slotted
page 17

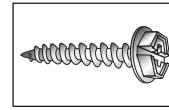

Hex Washer Head, Sheet Metal Screw, Phillips/Slotted
page 18

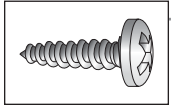

Pan Head, Sheet Metal Screw, Phillips
page 18

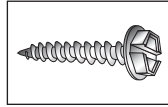

Hex Washer Head, Sheet Metal Screw, Slotted
page 19

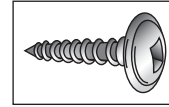

Round Washer Head, Sheet Metal Screw, Square
page 20

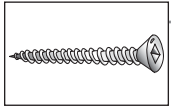

Flat Head, Sheet Metal Screw, Square
pages 21–22

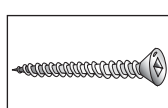

Flat & Oval Head, Sheet Metal Screw, Square
page 22

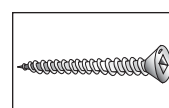

Truss Head SMS, Square
page 20

METAL PIERCING STUD SCREWS

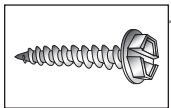

Hex Washer Head, Stud Screw, Slotted Sharp Point
page 23

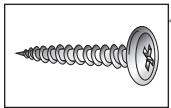

Wafer Head, Stud Screw, Phillips Sharp Point
page 23

FRAMING SCREWS

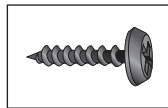

Pan Head Framing, Phillips
page 24

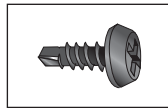

Pan Head Framing, Phillips Tek
page 24

TAPCON™ CONCRETE SCREWS

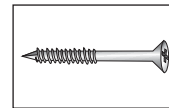

Flat Head, Concrete Screw, Phillips
page 87

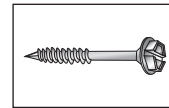

Hex Washer Head, Concrete Screw, Slotted
page 88

PLATE SCREWS

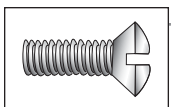

Wall Plate Oval Head, Slotted
page 38

CAP SCREWS

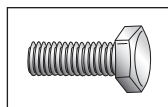

Hex Head Cap
pages 72–73

BRASS SCREWS

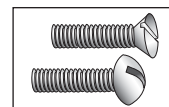

Brass Machine Screw, Round & Flat Head
page 50

TEK SCREWS

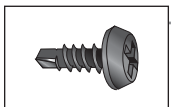

Pan Head Framing, Phillips Tek
page 24

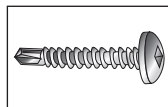

Pan Head, Square Tek
page 25

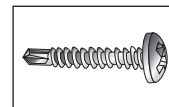

Pan Head, Phillips Tek
page 26

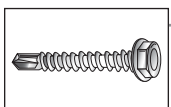

Hex Washer Head, Tek
pages 27–28

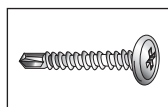

Wafer Head Lath, Phillips Tek
page 28

WOOD, PARTICLE BOARD, DRYWALL & DECK SCREWS

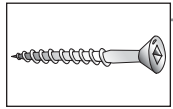

Flat Head, Wood Screw, Square
pages 39–40

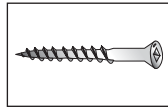

Trim Head, Wood Screw, Square
page 41

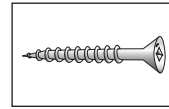

Deep Thread Particle Board, Square
pages 41–42



Fine Thread Drywall, Phillips
page 43

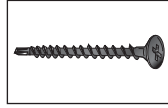

Fine Thread Drywall, Phillips Tek
page 43

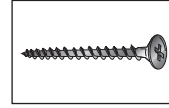

Coarse Thread Drywall, Phillips
page 44

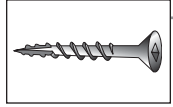

Woodex® All Weather Deck Screw, Square
page 45

TAMPERPROOF

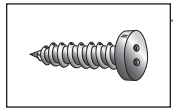

Spanner Head, Pan, Flat & Oval Head Sheet Metal Screw
page 46

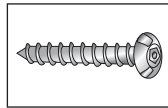

Socket Pin, Button Head Sheet Metal Screw
page 47

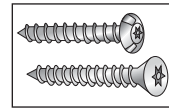

Star Pin, Button & Flat Head Sheet Metal Screw
page 47

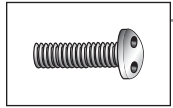

Spanner Head, Pan, Flat & Oval Head Machine Screw
page 48

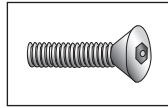

Socket Pin, Button & Flat Head Machine Screw
page 49

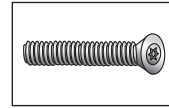

Star Pin, Button & Flat Head Machine Screw
page 49



Tamperproof Screwdriver
page 135



Tamperproof Kit
page 138



Tamperproof Bits
page 142

MACHINE SCREWS

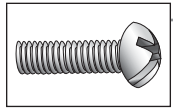

Round Head, Machine Screw, Phillips/Slotted
pages 29–30

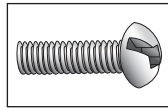

Round Head, Machine Screw, Square/Slotted
pages 31–32

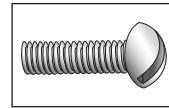

Round Head, Machine Screw, Slotted
page 33

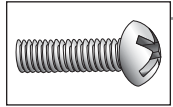

Round Head, Machine Screw, Phillips
page 33

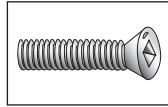

Flat Head, Machine Screw, Square
page 34

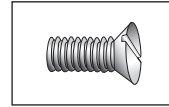

Flat Head, Machine Screw, Slotted
pages 35–36

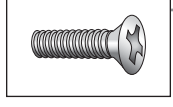

Flat Head, Machine Screw, Phillips
page 36

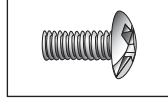

Truss Head, Machine Screw, Phillips/Slotted
page 37

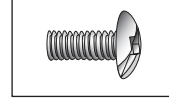

Truss Head, Machine Screw, Square/Slotted
page 37

SCREW HOOKS & EYES

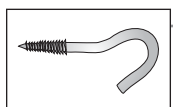

Screw Hooks
page 51

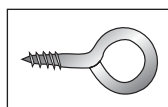

Screw Eyes
page 51

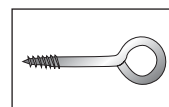

Screw Eye Lags
page 52

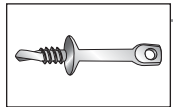

Acoustical Eye Tek
page 52

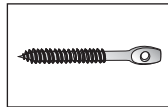

Acoustical Eye Lags
page 52

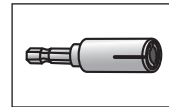

Acoustical Eye Driver
page 52

GROUNDING SCREWS

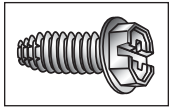

Grounding Screw
page 53



Grounding Pigtails
page 53



Grounding Clips
page 53

GROUNDING CLAMPS, RODS & ARMORED



Conduit Hubs
page 54



Ground Rod Clamps
page 54



Ground Clamps
page 54



Armored Ground Clamps
page 54



Ground Clamps with Threaded Hubs
page 54

NUTS

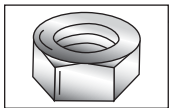

Hex Nuts & Grade 5
pages 55–57



Flange Whiz Nuts
page 57

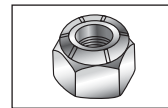

Nylock Nuts
page 58

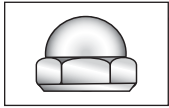

Cap Nuts
page 59

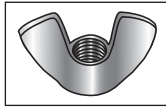

Wing Nuts
page 59

WASHERS

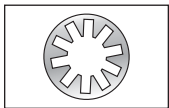

Toothed Lock Washers, Internal
page 60

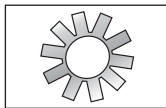

Toothed Lock Washers, External
page 60

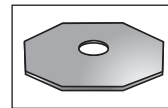

Sealing, Octagonal & Belleville Washers
pages 60–61

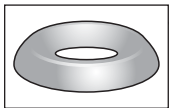

Finish Cup Washers
page 61



Flat Cut Washers
page 62–63



Fender Washers
page 64

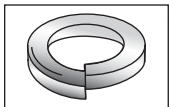

Split Lock Washers
pages 65–66

BOLTS & LAG SCREWS

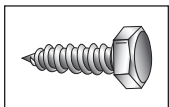

Hex Lag Screw
page 67

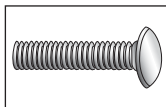

Carriage Bolts
page 68

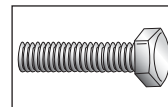

Hex Head Bolts, Grade 2
pages 69–70

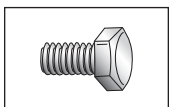

Hex Cap Screw, Grade 5
page 71

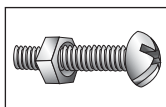

Stove Bolts, Round Head
page 74

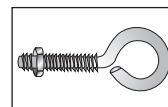

Eye Bolts
page 75

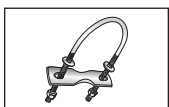

U-Bolts
page 75

ANCHORS

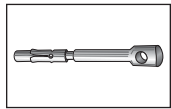

Acoustical Wedge Anchors
page 76



Double Drywall Anchors
page 78

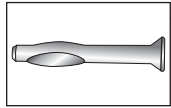

Flat Head Split Bolt Anchors
page 79

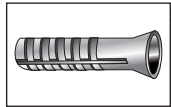

Lead Anchors
page 82



TOGLER® Snaptoggle® Toggle Bolt Anchors
page 84



Tapcon™ Condribe Installation Tool
page 87

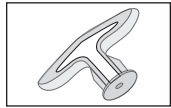

Plastic Toggle Anchors
page 91

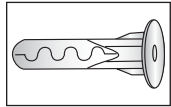

ALLIGATOR® Anchors
page 95

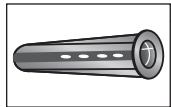

Red Plastic Conical Anchors
pages 97–98

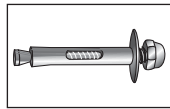

Sleeve Anchors
page 76

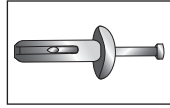

“Hammer Drive” Anchors
page 78

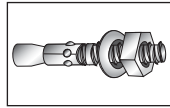

Wedge Anchors
pages 80–81

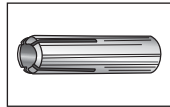

Steel Drop-In Anchors
page 83

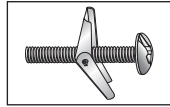

Toggle Bolts
pages 85–86

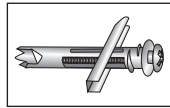

EZ Toggle™ Anchors
page 89

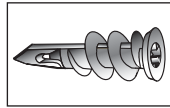

EZ Ancors™: Zinc, Mini, & Plastic
pages 91–93

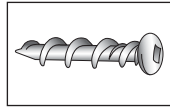

Pan Head Wall Dog Anchors
page 96

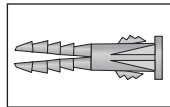

Yellow Plastic Winged Anchors
page 99

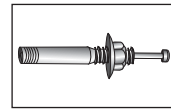

Strike Set Anchors
page 77

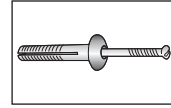

Nylon Nail-In Anchors
page 79

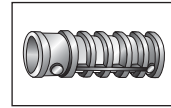

Lag Screw Shields
page 82

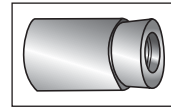

Lead Machine Screw Anchors
page 83

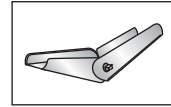

Toggle Bolt Wings
page 86

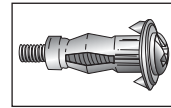

Hollow Wall Anchors
page 90



Toggler® Snapsku™
page 94

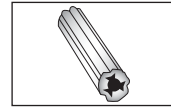

Green Plug Anchors
page 96

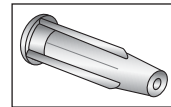

Expander Anchors
page 100

HANGERS

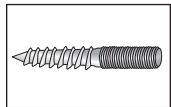

Hangerbolts
page 101



Hangerbolts Drivers
page 101



SAMMYS® for Wood & Steel
pages 102–103



SAMMYS® Nut Driver
pages 102–104



SAMMYS® for Concrete
page 104



SAMMYS® X-Press
page 105

HANGERS (CONT.)

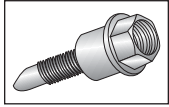

**Hangermate®,
Metal Applications**
page 106

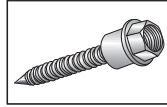

**Hangermate®,
Wood Applications**
page 106

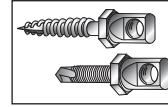

**Hangermate® Brute
Sidemount Applications**
page 107

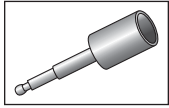

**Hangermate®
Installation Tools**
page 107



Threaded Rod
page 107

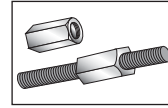

**Hex Rod &
Reducing Couplings**
page 108



Tie Wire
page 108

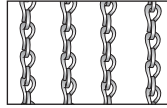

**Jack Chain & Double
Loop Tenso Chain**
page 109

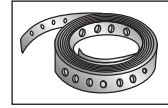

Plumbers Tape
page 110



S-Hooks
page 110

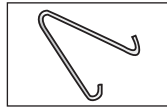

V-Hooks
page 110

PAINTS & CHEMICALS



**Krylon® Inverted
Marking Paint**
page 111



Marking Wand
page 112



Can Holster
page 112



Can Adapter
page 112



**Krylon® Acrylic
Enamel Paint**
page 113



**Sprayon®
Contact Cleaners**
page 116



**Sprayon® Cleaners &
Degreasers**
page 117



Sprayon® Lubricants
page 118



**Sprayon® & Krylon®
Corrosion Inhibitors &
Insulating Varnishes**
page 119



**Sprayon® General
Purpose & Glass Cleaners**
page 120



**Sprayon® Insecticides
& Insect Repellents**
page 121



Dura-Ink 15 Marker
page 122

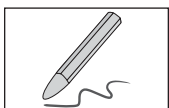

Lumber Crayons
page 122



**White Lightning®
Silicone Sealant**
page 124

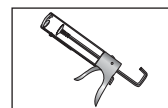

EZ-Thrust Caulk Gun
page 124



**Sprayon®
Clear Silicone**
page 124



Tri-Flow® Lubricants
page 124



**White Lightning®
Stop Gap!™**
page 125



**Wet Patch
Roof Cement**
page 125



**E-6000 Industrial
Adhesive**
page 125



Dark Cutting Oil
page 126



Duct Seal Compound
page 126

RAGS



All Purpose Rags
page 127



Scrubs-in-a-Bucket®
page 127

FIRESTOP PRODUCTS



Firestop Putty Pad
page 128



Lectra-Stop
page 128



Firestop Gaskets
page 128



Firestop Putty Sticks
page 129



Firestop Caulk
page 129



**Sausage Firestop
Caulking Gun**
page 129



Firestop Pillows
page 129

TOOLS • SHOVELS, RAKES, SLEDGE HAMMERS & FIBERGLASS HANDLED TOOLS



Shovels
pages 130–131



Rakes
pages 130–131



Irrigating/Floral
pages 130–131



Spades
pages 130–131



Sledge Hammers
pages 130–131



Pick Mattock
pages 130–131



Utility Probe
pages 130–131



Post Hole Digger
pages 130–131



**All Purpose Bar
with Tamper**
pages 130–131

TOOLS • TOOL BAGS & ACCESSORIES



**Electrician's Comfort
Combos**
pages 132–133



Pouches & Bags
pages 132–133



Belts & Suspenders
page 132



Meter Pouch
page 132



Drill Pouch
page 132



Hammer Holder
page 132



Phone Case
page 132



Tape Clip
page 132

TOOLS • SCREWDRIVERS, NUT DRIVERS & ACCESSORIES



**Megapro®
15-in-1 Screwdrivers**
page 134



**Megapro® Quick
Change Screwdriver**
page 135



**Megapro®
16-in-1 Tamperproof
Screwdriver**
page 135



**6-in-1 Economy
Screwdriver**
page 136



**13-in-1 Ratcheting
Screwdriver**
page 136



**14-in-1 HVAC
Screwdriver**
page 136



**15-in-1 Tamperproof 2
Screwdriver**
page 136



**15-in-1 Shaftlock 2
Screwdriver**
page 137



**Spanner Drive &
Un-Do It Tool**
page 137



**Square Drive
Screwdrivers**
page 137



Screwdrivers
page 138



**Tamperproof
29-in-1 Driver Kit**
page 138



Dial-A-Bit Kit
page 139



Magnetic Bit Holder
page 139

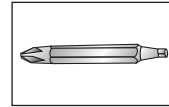

**Double Ended
Power Bit**
page 139



**Magnetizer/
Demagnetizer**
page 139

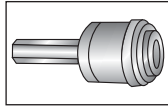

**Quick Change
Drill Adapter**
page 139

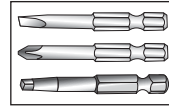

Hex Power Bits
pages 140–141

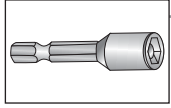

Hex Driver Bits
page 141



**Tamperproof
Insert Bits**
page 142

TOOLS • DRILL BITS

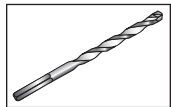

**Tapcon™ Carbide-Tipped
Masonry Drill Bits**
page 87

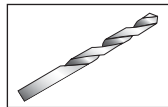

**High Speed
Jobber Drills**
pages 143–144

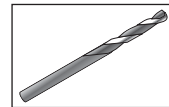

**Trinado Heavy Duty
Drills & Drill Index Set**
page 145



Dial-A-Drill Set
page 146



Hex Drill Set
page 146



Special Drill Sets
page 146

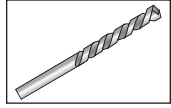

**Straight Shank
Carbide Drill Bits**
page 147

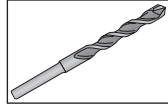

**Rotary/Precussion
Carbide Drill Bits**
page 147

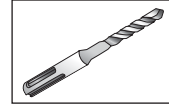

**SDS Rotary/Hammer
Carbide Drill Bits**
page 147

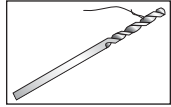

Bell Hanger Bits
page 148

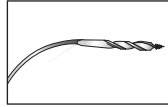

Flex Shank Drill Bits
page 148



**Electrician's
Power Bits**
page 148

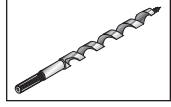

Ship Auger Bits
page 149

TOOLS • DRILL BITS (CONT.)

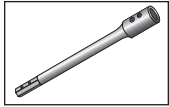

Auger Bit Extensions
page 149

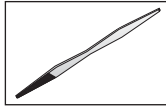

Auger Sharpening File
page 149

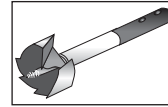

Sawtooth Self-Feeding Bits
page 150



Speedbor 2000™ Wood Bits
page 150

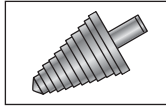

Step Drills
page 151

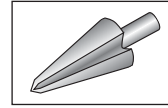

Cone Bits
page 151

TOOLS • HOLE SAWS, ARBORS & KITS

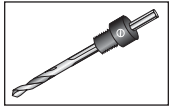

Hole Saw Arbors
page 151

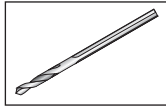

Pilot Drills
page 151



Variable Pitch Hole Saws
page 152



Hole Saw Kits
pages 152–153



Carbide Grit Hole Saws
page 153

TOOLS • TAPS & SCREW EXTRACTORS

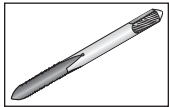

Carbon Steel Taps
page 154

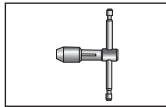

Carbon Steel Tap Wrenches
page 154



Carbon Steel Taps & Drill Set
page 154



Hex Shank Taps
page 154



Screw Extractor & Drill Bit Set
page 155



Damaged Screw Remover Set
page 155

TOOLS • SAW BLADES



Drywall Jab Saw
page 155

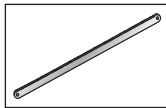

Hack Saw Blades
page 156

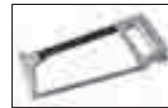

Hack Saw Frame
page 156

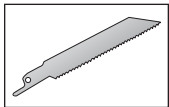

Reciprocating Saw Blades
page 156

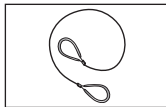

PVC Cable Saws
page 156

TOOLS • MISCELLANEOUS



Urseal Splice Kits
page 158



Tape Measure
page 159



Quickie Tie-Down Straps
page 159



Tarp Straps
page 159

TOOLS • KNIVES & ACCESSORIES



Accusharp Knife Sharpener
page 157



QuickBlade™ Ergonomic Utility Knife
page 157



Titan™ Folding Pocket Utility Knife
page 157

TOOLS • ROPE, PISTONS, LINE PACKAGES, PULLING TAPE & BLOW TWINE



Yellow Polypropylene Pull Rope
page 160



Polyester Pulling Tape/ Mule Tape
page 160



Line Packages
page 161



Polyester Conduit Measuring Tape
page 161



Polypropylene Blow Twine
page 161



Foam Conduit Pistons
page 162

TOOLS • CABLE MANAGEMENT



Receptical Shim
page 162



Non-Metallic Sheathed Cable Connectors
page 162



Steel Stud Bushings
page 163



Anti-Short Bushings
page 163



Knock-Out Bushings
page 163

TOOLS • TAPE

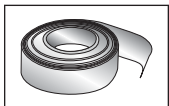

Color-Coded PVC Electrical Tape
page 164

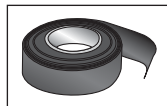

Black PVC Electrical Tape
page 164

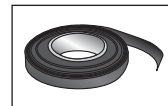

Rubber Tape
page 164

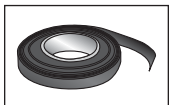

Friction Tape
page 164

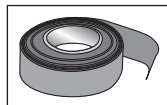

Duct Tape
page 165

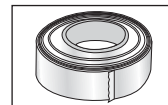

Carton Sealing Tape
page 165

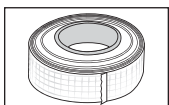

Strapping Tape
page 165



Pipe Wrap
page 165

SAFETY • BARRICADE TAPE



Barricade & Caution Tape
page 166



Underground Burial Tape
page 166



Underground Detectable Tape
page 166

SAFETY • SAFETY GLASSES



Crossfire® Safety Glasses
pages 167–168



Nemesis™ Safety Glasses
page 169



Smith & Wesson® Safety Glasses
page 170



Hellraiser™ Safety Glasses
page 170



OTG – Over The Glasses
page 170

SAFETY • SAFETY PRODUCTS



Disposable Dust Masks
page 171



Hearing Protection
page 171



Safety Vests
page 171



Charger™ Hard Hats
page 172



Block Head Hard Hats
page 172



Hard Hat Liners
page 172



First Aid Kits
page 173

SAFETY • WORK GLOVES



Split Leather Work Glove
page 174



1927® Cold Weather Grain Pigskin Glove
page 174



Split Leather Drivers Glove
page 174



Unlined Deerskin Drivers Glove
page 174



Unlined Grain Pigskin Drivers Glove
page 174



Grain Leather Drivers Glove
page 174



Unlined Brown Jersey Glove
page 174



Lined Brown Jersey Glove
page 174



Latex Coated Knit Glove
page 174

SAFETY • WORK GLOVES



Warm Grip Latex Work Glove
page 175



Frostbreaker® Thermal Latex Gripping Glove
page 175



Nitrile Palm Coated Glove
page 175



White String Knit Glove
page 175



PVC Dipped Glove
page 175



White Canvas Glove
page 175



Fingerless Ragg Wool Glove
page 175



Kevlar® Lined Glove
page 175



Pro-Grip Mechanic's Plus Glove
page 176



Pro-Grip Half Finger Work Glove
page 176



Pro-Grip Full Finger Work Glove
page 176



Pro-Grip Winter Plus Glove
page 176



Pro-Grip Mesh General Utility Glove
page 176

MISCELLANEOUS

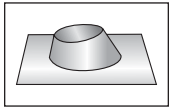

Roof Jacks
page 177



Service Entrance Caps
page 177



Pre-Kuts Plastic Sleepers
page 177



Cable Ties
page 179



Cable Tensioning Tool & Tie Kits
page 178



Mounting Bases
page 179

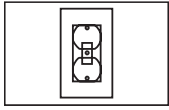

Wall Plate Insulating Gaskets
page 180



Mounting Ties
page 179

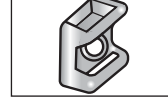

Plastic Cable Tie Fasteners
page 179



Ceiling Cover Plate
page 181

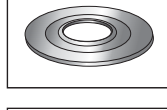

Reducing Washers
page 180

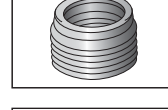

Reducing Bushings
page 180



Non-Metallic Knock-Out Seals
page 181

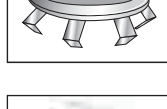

Snap-In Knock-Out Seals
page 181

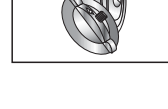

3-Piece Knock-Out Seals
page 181



Wire & Cable Marker Books
pages 182–183

Fasteners 14–110

SCREWS

- 14–22 Sheet Metal Screws
- 23 Metal Piercing Stud Screws
- 24 Framing Screws
- 25–28 Tek Self-Drilling Screws
- 29–37 Machine Screws
- 38 Plate Screws
- 39–41 Wood Screws
- 42 Particle Board Screws
- 43–44 Drywall Screws
- 45 Deck Screws
- 46–47 Tamperproof Sheet Metal Screws
- 48–49 Tamperproof Machine Screws
- 72–73 Cap Screws
- 50 Brass Screws
- 51 Screw Hooks & Eyes
- 52 Screw & Acoustical Eye Lags
- 87–88 Tapcon™ Concrete Screws

GROUNDING

- 53 Grounding Screws, Pigtails & Clips
- 54 Grounding Clamps, Rods & Armored with Hubs

NUTS/WASHERS

- 55–57 Hex Nuts
- 57 Flange Whiz Nuts
- 57 Grade 5 Hex Nuts
- 58 Nylock Hex Nuts
- 59 Cap & Wing Nuts
- 60 Lock Washers, Sealing & Octogonal Washers
- 61 Belleville & Finish Cup Washers
- 62–63 Flat Cut Washers
- 64 Fender Washers
- 65–66 Split Lock Washers

BOLTS

- 67 Hex Lag Screws
- 68 Carriage Bolts
- 69–71 Hex Head Bolts
- 72–73 Hex Cap Screws
- 74 Stove Bolts
- 75 Eye & U-Bolts

ANCHORS

- 76 Acoustical Wedge & Sleeve Anchors
- 77–81 Concrete/Masonry Anchors
- 82 Screw Anchors
- 83 Bolt Anchors
- 84, 90 Hollow Wall Anchors
- 85–86 Toggle Bolts & Wings
- 89 EZ Toggle™ Ancors
- 91 Toggler® Plastic Anchors & EZ Ancors™
- 92 EZ Mini Ancors™
- 93 White Plastic EZ Ancors™
- 94 SnapSku™ Self-Drilling Drywall Anchors
- 95 Toggler® Alligator® Solid Wall Anchors
- 96 Green Plug & Pan Head Wall Dog Anchors
- 97–98 Red Plastic Conical Anchors
- 99 Yellow Winged Anchors
- 100 Expander Anchors

HANGER

- 101 Hangerbolts & Hangerbolt Drivers
- 102–105 Sammy's® Anchoring Systems
- 106–110 Fixture Hanging Hardware

Paints & Chemicals 111–129

- 111 Inverted Marking Paint
- 112 Color Selection Guide
- 112 Paint Accessories
- 113 Acrylic Enamel Paint
- 114–115 Contact Cleaner Selection Guide
- 116 Contact Cleaners
- 117 Electrical & Electronic Cleaners & Degreasers
- 118 Lubricants
- 119 Corrosion Inhibitors & Insulating Varnishes
- 120 General Purpose & Glass Cleaner
- 121 Insect Repellents
- 122 Markers
- 123 Paint & Chemicals Technical Glossary
- 124–125 Sealants & Adhesives
- 124 Tri-Flow Lubricant
- 126 Cutting Oil & Duct Seal Compound
- 127 All Purpose Rags & Scrubs
- 128–129 Firestop Products

Tools 130–165

- 130–131 Fiberglass Handled Tools
- 132–133 Tool Bags & Accessories
- 134–135 Megapro® Screwdrivers
- 136–137 Screwdrivers
- 137 Spanner Drive & Un-Do It Tool
- 138 Tamperproof Driver Bits
- 139 Dial-A-Bit Kit & Driver Bit Accessories
- 140–141 Hex Power Bits
- 141 Hex Driver Bits
- 142 Tamperproof Insert Bits
- 143–144 High Speed Jobber Drills
- 145 Trinado Heavy-Duty Drills
- 146 Drill Bits
- 147 Carbide Drill Bits
- 148–150 Wood Bits
- 151 Step Drills, Cone Bits, Hole Saw Arbors & Pilot Drills
- 152–153 Hole Saws
- 154 Carbon Steel & Hex Shank Taps
- 155 Screw Extractors
- 155–156 Drywall Jab Saw & Saw Blades
- 157 Knife Sharpeners & Utility Knives
- 158 Uraseal Splice Kits
- 159 Tape Measure
- 159 Tie Down Straps
- 160 Polypropylene Pull Rope & Pulling/Mule Tape
- 161 Conduit Tape, Blow Twine & Line Packages
- 162 Foam Conduit Pistons
- 162–163 Cable Management
- 164–165 Tape
- 165 Pipe Wrap

Safety 166–176

- 166 Barricade Tape
- 167–168 Crossfire® Safety Glasses
- 169–170 Safety Glasses
- 171 Dust Masks, Hearing Protection & Safety Vests
- 172 Hard Hats & Liners
- 173 First Aid Kits
- 174–176 Work Gloves

Miscellaneous 177–183

- 177 Roof Jacks, Service Entrance Caps & Pre-Kuts
- 178–179 Cable Management
- 180 Gaskets, Reducing Washers & Bushings
- 181 Ceiling Cover Plate & Knock-Out Seals
- 182–183 Marker Books



PAN HEAD SHEET METAL SCREWS • SQUARE DRIVE • ZINC

FASTENERS • SCREWS

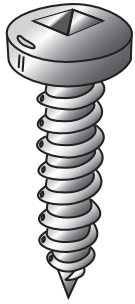

▲ Contact customer service for gravity feed jar availability.
*These items are packaged in cardboard boxes.

For bulk packaging, contact customer service for quantities and availability.

		Best Merchandising Option					
		Plastic Box	Gravity Feed Jar		Job Jar		
Size	Bit Size	Part #	Box Qty/ Std Pk	Part #	Jar Qty/ Std Pk	Part #	Jar Qty
4 x 3/8	#0	10406	100/500	▲		—	
4 x 1/2		10408	100/500	▲		—	
4 x 5/8		10410	100/500	▲		—	
4 x 3/4		10412	100/500	▲		—	
6 x 1/4	#1	10604	100/500	▲		—	
6 x 3/8		10606	100/500	▲		—	
6 x 1/2		10608	100/500	▲		—	
6 x 5/8		10610	100/500	▲		—	
6 x 3/4		10612	100/500	10612J	100/1200	—	
6 x 1		10616	100/500	10616J	100/1200	—	
6 x 1 1/4		10620	100/500	▲		—	
6 x 1 1/2		10624	100/500	10624J	100/1200	—	
6 x 1 3/4		10628	100/500	▲		—	
6 x 2		10632	100/500	10632J	100/600	—	
8 x 3/8	#2	10806	100/500	10806J	100/600	—	
8 x 1/2		10808	100/500	10808J	100/600	—	
8 x 5/8		10810	100/500	▲		—	
8 x 3/4		10812	100/500	10812J	100/1200	10812-6	1000
8 x 1		10816	100/500	10816J	100/1200	10816-6	750
8 x 1 1/4		10820	100/500	10820J	100/1200	10820-6	500
8 x 1 1/2		10824	100/500	10824J	100/600	10824-6	500
8 x 1 3/4		10828	50/250	▲		—	
8 x 2		10832	50/250	10832J	100/600	—	
8 x 2 1/2		10840	*100	10840J	100/600	—	
8 x 3		10848	*100	▲		—	
10 x 1/2	#2	11008	100/500	11008J	100/1200	11008-6	1000
10 x 5/8		11010	100/500	11010J	100/1200	—	
10 x 3/4		11012	100/500	11012J	100/1200	11012-6	750
10 x 1		11016	100/500	11016J	100/1200	11016-6	500
10 x 1 1/4		11020	100/500	11020J	100/1200	11020-6	500
10 x 1 1/2		11024	50/250	11024J	100/600	11024-6	350
10 x 1 3/4		11028	50/250	▲		—	
10 x 2		11032	50/250	11032J	100/600	11032-6	250
10 x 2 1/2		11040	*100	11040J	100/600	—	
10 x 3		11048	*100	11048J	100/600	—	
12 x 1/2	#3	11208	100/500	11208J	100/1200	—	
12 x 5/8		11210	100/500	▲		—	
12 x 3/4		11212	100/500	11212J	100/1200	—	
12 x 1		11216	100/500	11216J	100/1200	—	
12 x 1 1/4		11220	50/250	11220J	100/600	—	
12 x 1 1/2		11224	50/250	11224J	100/600	—	
12 x 1 3/4		11228	50/250	▲		—	
12 x 2		11232	50/250	11232J	100/600	—	
12 x 2 1/2		11240	*100	11240J	100/600	—	
12 x 3		11248	*100	11248J	100/600	—	

Continued on next page.

PAN HEAD SHEET METAL SCREWS • SQUARE DRIVE • ZINC (CONT.)

		Best Merchandising Option					
		Plastic Box	Gravity Feed Jar	Job Jar			
Size	Bit Size	Part #	Box Qty/ Std Pk	Part #	Jar Qty/ Std Pk	Part #	Jar Qty
14 x ½	#3	11408	100/500	▲		—	
14 x ⅝		11410	100/500	▲		—	
14 x ¾		11412	100/500	▲		—	
14 x 1		11416	50/250	▲		—	
14 x 1¼		11420	50/250	▲		—	
14 x 1½		11424	50/250	▲		—	
14 x 1¾		11428	50/250	▲		—	
14 x 2		11432	25/125	▲		—	
14 x 2½		11440	*100	▲		—	
14 x 3		11448	*100	▲		—	



FASTENERS • SCREWS

Kits			
Part #	Description		
39551 (396 Piece Kit)	#6 Pan Head Sheet Metal Screw Square Drive Kit Includes a #1-2" Square Drive Power Bit		
	½" (100 Pieces)	1" (75 Pieces)	1½" (40 Pieces)
	¾" (100 Pieces)	1¼" (50 Pieces)	2" (30 Pieces)
39552 (316 Piece Kit)	#8 Pan Head Sheet Metal Screw Square Drive Screw Kit Includes a #2-2" Square Drive Power Bit		
	½" (100 Pieces)	1" (50 Pieces)	1½" (35 Pieces)
	¾" (60 Pieces)	1¼" (40 Pieces)	2" (30 Pieces)
39553 (231 Piece Kit)	#10 Pan Head Sheet Metal Screw Square Drive Screw Kit Includes a #2-2" Square Drive Power Bit		
	½" (70 Pieces)	1" (35 Pieces)	1½" (25 Pieces)
	¾" (50 Pieces)	1¼" (30 Pieces)	2" (20 Pieces)

▲ Contact customer service for gravity feed jar availability.
*These items are packaged in cardboard boxes.

For bulk packaging, contact customer service for quantities and availability.

PAN HEAD SHEET METAL SCREWS • SQUARE DRIVE • 18-8 STAINLESS STEEL

FASTENERS • SCREWS

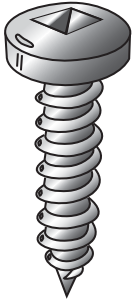

				Best Merchandising Option	
		Plastic Box		Gravity Feed Jar	
Size	Bit	Part #	Box Qty/ Std Pk	Part #	Jar Qty/ Std Pk
6 x 1/2	#1	70608	100/500		▲
6 x 3/4		70612	100/500		▲
6 x 1		70616	100/500		▲
6 x 1 1/4		70620	100/500		▲
8 x 1/2	#2	70808	100/500		▲
8 x 5/8		70810	100/500		▲
8 x 3/4		70812	100/500		▲
8 x 1		70816	100/500		▲
8 x 1 1/4		70820	100/500		▲
8 x 1 1/2		70824	100/500		▲
8 x 2		70832	50/250		▲
10 x 1/2	#2	71008	100/500		▲
10 x 5/8		71010	100/500		▲
10 x 3/4		71012	100/500		▲
10 x 1		71016	100/500	71016J	100/1200
10 x 1 1/4		71020	100/500	71020J	100/1200
10 x 1 1/2		71024	50/250	71024J	50/600
10 x 2		71032	50/250	71032J	50/600
10 x 2 1/2		71040	*100		▲
12 x 3/4	#3	71212	100		▲
12 x 1		71216	100		▲
12 x 1 1/4		71220	50/250		▲
12 x 1 1/2		71224	50/250		▲
12 x 2		71232	50/250		▲
12 x 2 1/2		71240	*100		▲
14 x 3/4	#3	71412	100		▲
14 x 1		71416	50/250		▲
14 x 1 1/4		71420	50/250		▲
14 x 1 1/2		71424	50/250		▲
14 x 2		71432	25/125		▲
14 x 2 1/2		71440	*100		▲
14 x 3		71448	*100		▲

▲ Contact customer service for gravity feed jar availability.

*These items are packaged in cardboard boxes.

Harsh Environment Product

For bulk packaging, contact customer service for quantities and availability.

PAN HEAD SHEET METAL SCREWS • PHILLIPS/SLOTTED COMBO • ZINC

		Best Merchandising Option					
		Plastic Box	Gravity Feed Jar	Job Jar			
Size	Bit Size	Part #	Box Qty/ Std Pk	Part #	Jar Qty/ Std Pk	Part #	Jar Qty
6 x 1/2	#1	18609	100/500	18609J	100/1200	—	—
6 x 3/4		18613	100/500	18613J	100/1200	—	—
6 x 1		18617	100/500	18617J	100/1200	—	—
6 x 1 1/4		18621	100/500	18621J	100/1200	—	—
6 x 1 1/2		18625	100/500	18625J	100/1200	—	—
8 x 1/2	#2	18809	100/500	18809J	100/1200	—	—
8 x 3/4		18813	100/500	18813J	100/1200	18813-6	1000
8 x 1		18817	100/500	18817J	100/1200	18817-6	750
8 x 1 1/4		18821	100/500	18821J	100/1200	18821-6	500
8 x 1 1/2		18825	100/500	18825J	100/1200	—	—
8 x 2		18833	50/250	18833J	100/600	—	—
10 x 1/2	#2	19009	100/500	19009J	100/1200	19009-6	1000
10 x 3/4		19013	100/500	19013J	100/1200	19013-6	750
10 x 1		19017	100/500	19017J	100/1200	19017-6	500
10 x 1 1/4		19021	100/500	19021J	100/1200	19021-6	500
10 x 1 1/2		19025	50/250	19025J	100/600	19025-6	350
10 x 2		19033	50/250	19033J	100/600	19033-6	250
10 x 2 1/2		19041	*100	19041J	100/600	—	—
10 x 3		19049	*100	19049J	100/600	—	—
12 x 1/2	#3	19209	100/500	19209J	100/1200	—	—
12 x 3/4		19213	100/500	19213J	100/1200	—	—
12 x 1		19217	100/500	19217J	100/1200	—	—
12 x 1 1/4		19221	50/250	19221J	100/600	—	—
12 x 1 1/2		19225	50/250	19225J	100/600	—	—
12 x 2		19233	50/250	19233J	100/600	—	—
12 x 2 1/2		19241	*100	19241J	100/600	—	—
12 x 3		19249	*100	19249J	100/600	—	—
14 x 3/4	#3	19413	100/500	19413J	100/1200	—	—
14 x 1		19417	50/250	19417J	100/600	—	—
14 x 1 1/4		19421	50/250	19421J	100/600	—	—
14 x 1 1/2		19425	50/250	19425J	100/600	—	—
14 x 2		19433	25/125	19433J	100/600	—	—



FASTENERS • SCREWS

*These items are packaged in cardboard boxes.

For bulk packaging, contact customer service for quantities and availability.

		Kits		
Part #	Description			
39556 (316 Piece Kit)	#8 Pan Head Sheet Metal Screw Combo Phillips/Slotted Kit Includes a #2-2" Phil Power Bit			
	1/2" (100 Pieces)	1" (50 Pieces)	1 1/2" (35 Pieces)	
	3/4" (60 Pieces)	1 1/4" (40 Pieces)	2" (30 Pieces)	
39557 (231 Piece Kit)	#10 Pan Head Sheet Metal Screw Combo Phillips/Slotted Kit Includes a #2-2" Phil Power Bit			
	1/2" (70 Pieces)	1" (35 Pieces)	1 1/2" (25 Pieces)	
	3/4" (50 Pieces)	1 1/4" (30 Pieces)	2" (20 Pieces)	

PAN HEAD SHEET METAL SCREWS • PHILLIPS • 18-8 STAINLESS STEEL

FASTENERS • SCREWS



		Best Merchandising Option					
		Plastic Box		Gravity Feed Jar		Job Jar	
Size	Bit Size	Part #	Box Qty/ Std Pk	Part #	Jar Qty/ Std Pk	Part #	Jar Qty
10 x 3/4	#2	81012SS	100/500	81012SSJ	100/1200	—	—
10 x 1		81016SS	100/500	81016SSJ	100/1200	—	—
10 x 1 1/4		81020SS	100/500	81020SSJ	100/1200	—	—
10 x 1 1/2		81024SS	50/250	81024SSJ	100/600	—	—
10 x 2		81032SS	50/250	81032SSJ	100/600	—	—

Harsh Environment Product

HEX WASHER HEAD SHEET METAL SCREWS • PHILLIPS/SLOTTED COMBO • ZINC



		Best Merchandising Option					
		Plastic Box		Gravity Feed Jar		Job Jar	
Size	Head Size	Part #	Box Qty/ Std Pk	Part #	Jar Qty/ Std Pk	Part #	Jar Qty
10 x 1/2	5/16"	77008	100/500	77008J	100/1200	77008-6	1000
10 x 3/4		77012	100/500	77012J	100/1200	77012-6	750
10 x 1		77016	100/500	77016J	100/1200	77016-6	500
10 x 1 1/4		77020	100/500	77020J	100/600	77020-6	500
10 x 1 1/2		77024	50/250	77024J	100/600	77024-6	350
10 x 2		77032	50/250	77032J	100/600	77032-6	250

Kits			
Part #	Description		
39562	#10 HWH Sheet Metal Screw Combo Phillips/Slotted Kit		
(211 Piece Kit)	Includes a 5/16" Hex Driver		
	1/2" (60 Pieces)	1" (35 Pieces)	1 1/2" (25 Pieces)
	3/4" (40 Pieces)	1 1/4" (30 Pieces)	2" (20 Pieces)

For bulk packaging, contact customer service for quantities and availability.

HEX WASHER HEAD SHEET METAL SCREWS • SLOTTED • ZINC

FASTENERS • SCREWS

		Best Merchandising Option					
		Plastic Box	Gravity Feed Jar	Job Jar			
Size	Bit Size	Part #	Box Qty/ Std Pk	Part #	Jar Qty/ Std Pk	Part #	Jar Qty
6 x 1/2	1/4"	76608	100/500	▲		—	
6 x 5/8		76610	100/500	▲		—	
6 x 3/4		76612	100/500	▲		—	
6 x 1		76616	100/500	76616J	100/1200	—	
6 x 1 1/4		76620	100/500	▲		—	
6 x 1 1/2		76624	100/500	▲		—	
8 x 1/2	1/4"	76808	100/500	76808J	100/1200	—	
8 x 5/8		76810	100/500	▲		—	
8 x 3/4		76812	100/500	76812J	100/1200	—	
8 x 1		76816	100/500	76816J	100/1200	—	
8 x 1 1/4		76820	100/500	76820J	100/1200	—	
8 x 1 1/2		76824	100/500	76824J	100/1200	—	
8 x 2		76832	50/250	76832J	100/600	—	
8 x 2 1/2		76840	*100	76840J	100/600	—	
8 x 3		76848	*100	76848J	100/600	—	
10 x 5/8	5/16"	77010	100/500	▲		—	
10 x 1 3/4		77028	50/250	▲		—	
10 x 2 1/2		77040	*100	77040J	100/600	—	
10 x 3		77048	*100	77048J	100/600	—	
12 x 1/2	5/16"	77208	100/500	77208J	100/1200	—	
12 x 3/4		77212	100/500	77212J	100/1200	—	
12 x 1		77216	100/500	77216J	100/1200	—	
12 x 1 1/4		77220	50/250	77220J	100/600	—	
12 x 1 1/2		77224	50/250	77224J	100/600	—	
12 x 2		77232	50/250	77232J	100/600	—	
12 x 2 1/2		77240	*100	▲		—	
12 x 3		77248	*100	77248J	100/600	—	
14 x 1/2	3/8"	77408	100/500	▲		—	
14 x 3/4		77412	100/500	▲		—	
14 x 1		77416	50/250	77416J	100/600	—	
14 x 1 1/4		77420	50/250	77420J	100/600	—	
14 x 1 1/2		77424	50/250	▲		—	
14 x 2		77432	25/125	77432J	100/600	—	
14 x 2 1/2		77440	*100	77440J	100/600	—	
14 x 3		77448	*100	77448J	100/600	—	



▲ Contact customer service for gravity feed jar availability.

*These items are packaged in cardboard boxes.

For bulk packaging, contact customer service for quantities and availability.



Kits

Part #	Description			
39561 (286 Piece Kit)	#8 HWH Sheet Metal Screw Slotted Kit			
	Includes a 1/4" Hex Driver			
	1/2" (100 Pieces)	1" (40 Pieces)	1 1/2" (25 Pieces)	
	3/4" (60 Pieces)	1 1/4" (35 Pieces)	2" (25 Pieces)	

ROUND WASHER HEAD SHEET METAL SCREWS • SQUARE DRIVE • ZINC

FASTENERS • SCREWS



		Best Merchandising Option					
		Plastic Box	Gravity Feed Jar		Job Jar		
Size	Bit Size	Part #	Box Qty/ Std Pk	Part #	Jar Qty/ Std Pk	Part #	Jar Qty
8 x 1/2	#2	14808	100/500	14808J	100/1200	—	—
8 x 5/8		14810	100/500	14810J	100/1200	—	—
8 x 3/4		14812	100/500	14812J	100/1200	14812-6	1000
8 x 1		14816	100/500	14816J	100/1200	14816-6	750
8 x 1 1/4		14820	100/500	14820J	100/1200	14820-6	500
8 x 1 1/2		14824	100/500	14824J	100/1200	—	—
8 x 1 3/4		14828	50/250	▲	—	—	—
8 x 2		14832	50/250	14832J	100/600	—	—
8 x 2 1/2		14840	*100	▲	—	—	—
10 x 1/2	#2	15008	100/500	15008J	100/1200	15008-6	1000
10 x 3/4		15012	100/500	15012J	100/1200	15012-6	750
10 x 1		15016	100/500	15016J	100/1200	15016-6	500
10 x 1 1/4		15020	100/500	15020J	100/1200	15020-6	500
10 x 1 1/2		15024	50/250	15024J	100/600	15024-6	350
10 x 2		15032	50/250	15032J	100/600	15032-6	250
12 x 3/4	#3	15212	100/500	▲	—	—	—
12 x 1		15216	100/500	▲	—	—	—

▲ Contact customer service for gravity feed jar availability.

*These items are packaged in cardboard boxes.

For bulk packaging, contact customer service for quantities and availability.

Kits				
Part #	Description			
39565 (261 Piece Kit)	#8 RWH Sheet Metal Screw Square Drive Kit Includes a #2-2" Power Bit			
	1/2" (80 Pieces)	1" (45 Pieces)	1 1/2" (30 Pieces)	
	3/4" (50 Pieces)	1 1/4" (30 Pieces)	2" (25 Pieces)	
39566 (211 Piece Kit)	#10 RWH Sheet Metal Screw Square Drive Kit Includes a #2-29 Power Bit			
	1/2" (60 Pieces)	1" (35 Pieces)	1 1/2" (22 Pieces)	
	3/4" (50 Pieces)	1 1/4" (25 Pieces)	2" (18 Pieces)	

TRUSS HEAD SMS • SQUARE DRIVE • ZINC

▲ Contact customer service for gravity feed jar availability.

*These items are packaged in cardboard boxes.

		Best Merchandising Option		
		Plastic Box	Gravity Feed Jar	
Size	Part #	Box Qty/ Std Pk	Part #	Jar Qty/ Std Pk
8 x 3	14849	*100	▲	—
10 x 3	15049	*100	▲	—

For bulk packaging, contact customer service for quantities and availability.

FLAT HEAD SHEET METAL SCREWS • SQUARE DRIVE • ZINC

		Best Merchandising Option					
		Plastic Box	Gravity Feed Jar	Job Jar			
Size	Bit Size	Part #	Box Qty/ Std Pk	Part #	Jar Qty/ Std Pk	Part #	Jar Qty
6 x 3/8	#1	12606	100/500	▲		—	
6 x 1/2		12608	100/500	12608J	100/1200	—	
6 x 5/8		12610	100/500	▲		—	
6 x 3/4		12612	100/500	12612J	100/1200	—	
6 x 1		12616	100/500	12616J	100/1200	—	
6 x 1 1/4		12621	100/500	▲		—	
6 x 1 1/2		12625	100/500	▲		—	
6 x 2		12633	100/500	▲		—	
8 x 1/2	#2	12808	100/500	12808J	100/1200	—	
8 x 5/8		12810	100/500	12810J	100/1200	—	
8 x 3/4		12812	100/500	12812J	100/1200	—	
8 x 1		12816	100/500	12816J	100/1200	—	
8 x 1 1/4		12821	100/500	12821J	100/1200	—	
8 x 1 1/2		12825	100/500	▲		—	
8 x 2		12833	50/250	▲		—	
10 x 1/2	#2	13008	100/500	▲		—	
10 x 5/8		13010	100/500	▲		—	
10 x 3/4		13012	100/500	13012J	100/1200	—	
10 x 1		13016	100/500	13016J	100/1200	—	
10 x 1 1/4		13021	100/500	▲		—	
10 x 1 1/2		13025	50/250	▲		—	
10 x 2		13033	50/250	▲		—	
12 x 3/4	#3	13212	100/500	▲		—	
12 x 1		13216	100/500	▲		—	
12 x 1 1/4		13221	50/250	▲		—	
12 x 1 1/2		13225	50/250	▲		—	

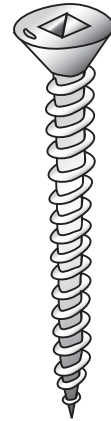

FASTENERS • SCREWS

▲ Contact customer service for gravity feed jar availability.

For bulk packaging, contact customer service for quantities and availability.

FLAT & OVAL HEAD SHEET METAL SCREWS • SQUARE DRIVE • 18-8 STAINLESS STEEL



Flat Head		Plastic Box	
Size	Bit	Part #	Box Qty/ Std Pk
6 x 1/2	#1	72608	100/500
6 x 3/4		72612	100/500
6 x 1		72616	100/500
6 x 1 1/4		72620	100/500
8 x 1/2	#2	72808	100/500
8 x 5/8		72810	100/500
8 x 3/4		72812	100/500
8 x 1		72816	100/500
8 x 1 1/4		72820	100/500
8 x 1 1/2		72824	100/500
8 x 1 3/4		72828	100/500
8 x 2		72832	50/250
8 x 2 1/2		72840	*100
8 x 3		72848	*100
10 x 3/4	#2	73012	100/500
10 x 1		73016	100/500
10 x 1 1/4		73020	100/500
10 x 1 1/2		73024	50/250
10 x 1 3/4		73028	50/250
10 x 2		73032	50/250
10 x 2 1/2		73040	*100
10 x 3		73048	*100
12 x 1	#3	73216	100
12 x 1 1/4		73220	50/250
12 x 1 1/2		73224	50/250
12 x 1 3/4		73228	50/250
12 x 2		73232	50/250
12 x 2 1/2		73240	*100
12 x 3		73248	*100
14 x 1	#3	73416	50/250
14 x 1 1/4		73420	50/250
14 x 1 1/2		73424	50/250
14 x 2		73432	25/125
14 x 2 1/2		73440	*100
14 x 3		73448	*100

Oval Head		Plastic Box	
Size	Bit	Part #	Box Qty/ Std Pk
6 x 1/2	#1	75608	100/500
6 x 3/4		75612	100/500
6 x 1		75616	100/500
8 x 3/4	#2	75812	100/500
8 x 1		75816	100/500
8 x 1 1/4		75820	100/500
8 x 2		75832	50/250
10 x 3/4	#2	76012	100/500
10 x 1		76016	100/500
10 x 1 1/4		76020	100/500
10 x 1 1/2		76024	50/250
10 x 1 3/4		76028	50/250
10 x 2		76032	50/250
10 x 2 1/2		76040	*100
10 x 3		76048	*100

*These items are packaged in cardboard boxes.

Harsh Environment Product

For bulk packaging, contact customer service for quantities and availability.

HEX WASHER HEAD SHARP POINTS • SLOTTED • ZINC

		Best Merchandising Option					
		Plastic Box	Gravity Feed Jar			Job Jar	
Size	Bit Size	Part #	Box Qty/ Std Pk	Part #	Jar Qty/ Std Pk	Part #	Jar Qty
7 x 1/2	1/4"	79505	100/500	79505J	100/600	79505-6	1000
8 x 1/2	1/4"	79508	100/500	79508J	100/1200	79508-6	1000
8 x 3/4		79512	100/500	79512J	100/1200	79512-6	1000
8 x 1		79516	100/500	79516J	100/1200	79516-6	500
8 x 1 1/2		79524	100/500	79524J	100/600	79524-6	500
8 x 2		79532	50/250	79532J	100/600	79532-6	250



FASTENERS • SCREWS

WAFER HEAD SHARP POINTS • PHILLIPS • ZINC

		Best Merchandising Option					
		Plastic Box	Gravity Feed Jar			Job Jar	
Size	Bit Size	Part #	Box Qty/ Std Pk	Part #	Jar Qty/ Std Pk	Part #	Jar Qty
8 x 1/2	#2	14809	100/500	14809J	100/1200	14809-6	1000
8 x 5/16		14811	100/500	14811J	100/1200	14811-6	1000
8 x 3/4		14813	100/500	14813J	100/1200	14813-6	1000
8 x 1		14817	100/500	14817J	100/1200	14817-6	500
8 x 1 1/4		14821	100/500	14821J	100/1200	14821-6	500



		Kits					
Part #	Description						
39558 (381 Piece Kit)	#8 Wafer Head Lath Sharp Point Screw Kit Includes a #2-2" Power Bit						
	Sharp Point						
	1/2" (80 Pieces)	5/16" (60 Pieces)	3/4" (50 Pieces)				
	Tek						
1/2" (80 Pieces)	5/16" (60 Pieces)	3/4" (50 Pieces)					

For bulk packaging, contact customer service for quantities and availability.

PAN HEAD FRAMING SCREWS • PHILLIPS • SUPER SHARP • BLACK

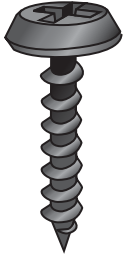

- Features sharp point metal piercing tip.
- No pre-drilling.
- Perfect for thin-gauge metal applications (up to 20 gauge).

		Best Merchandising Option					
		Plastic Box		Gravity Feed Jar		Job Jar	
Size	Bit Size	Part #	Box Qty/ Std Pk	Part #	Jar Qty/ Std Pk	Part #	Jar Qty
7 x 7/16	#2	10707	100/500	10707J	100/1200	10707-6	1000

PAN HEAD FRAMING SCREWS • PHILLIPS • TEK • BLACK

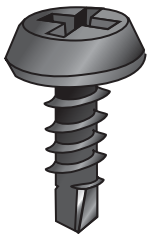

- Great for metal-to-metal applications in steel and aluminum up to 12 gauge.

		Best Merchandising Option					
		Plastic Box		Gravity Feed Jar		Job Jar	
Size	Bit Size	Part #	Box Qty/ Std Pk	Part #	Jar Qty/ Std Pk	Part #	Jar Qty
7 x 7/16	#2	10708	100/500	10708J	100/1200	10708-6	1000

For bulk packaging, contact customer service for quantities and availability.

PAN HEAD TEK SCREWS • SQUARE DRIVE • ZINC

		Best Merchandising Option					
		Plastic Box	Gravity Feed Jar	Job Jar			
Size	Bit Size	Part #	Box Qty/ Std Pk	Part #	Jar Qty/ Std Pk	Part #	Jar Qty
6 x 3/8	#1	26606	100/500	26606J	100/1200	—	
8 x 1/2	#2	26808	100/500	26808J	100/1200	26808-6	1000
8 x 5/8		26810	100/500	26810J	100/1200	—	
8 x 3/4		26812	100/500	26812J	100/1200	26812-6	750
8 x 1		26816	100/500	26816J	100/1200	26816-6	750
8 x 1 1/4		26820	100/500	26820J	100/1200	—	
10 x 1/2	#2	27008	100/500	27008J	100/1200	27008-6	750
10 x 5/8		27010	100/500	27010J	100/1200	—	
10 x 3/4		27012	100/500	27012J	100/1200	27012-6	750
10 x 1		27016	100/500	27016J	100/1200	27016-6	500
10 x 1 1/4		27020	100/500	27020J	100/1200	27020-6	500
10 x 1 1/2		27024	50/250	27024J	100/600	27024-6	350
10 x 2		27032	50/250	27032J	100/600	27032-6	250
12 x 3/4	#3	27212	100/500	▲		—	
12 x 1		27216	100/500	27216J	100/1200	—	
12 x 1 1/4		27220	50/250	▲		—	

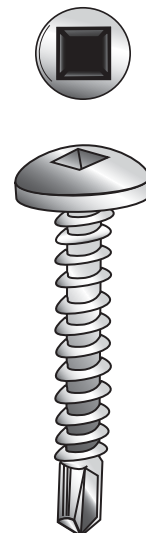

FASTENERS • SCREWS

Kits			
Part #	Description		
39505 (381 Piece Kit)	#8 & #10 Pan Head Square Drive Tek Screw Kit Includes a #2-2" Power Bit		
	8 x 1/2" (100 Pieces)	8 x 3/4" (60 Pieces)	8 x 1" (50 Pieces)
	10 x 1/2" (80 Pieces)	10 x 3/4" (50 Pieces)	10 x 1" (40 Pieces)

▲ Contact customer service for gravity feed jar availability.

For bulk packaging, contact customer service for quantities and availability.

PAN HEAD TEK SCREWS • PHILLIPS • ZINC

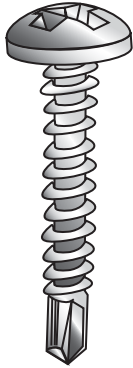

- #6 Tek Screws feature a #1 drill point.
- # 8 & #10 Tek Screws feature a #2 drill point.

		Best Merchandising Option					
		Plastic Box	Gravity Feed Jar	Job Jar			
Size	Bit Size	Part #	Box Qty/ Std Pk	Part #	Jar Qty/ Std Pk	Part #	Jar Qty
6-20 x 1/2	#1	82608	100/500	82608J	100/1200	—	—
6-20 x 5/8		82610	100/500	▲		—	—
6-20 x 3/4		82612	100/500	82612J	100/1200	—	—
6-20 x 1		82616	100/500	82616J	100/1200	—	—
8-18 x 1/2	#2	82808	100/500	82808J	100/1200	—	—
8-18 x 5/8		82810	100/500	82810J	100/1200	—	—
8-18 x 3/4		82812	100/500	82812J	100/1200	—	—
8-18 x 1		82816	100/500	82816J	100/1200	—	—
8-18 x 1 1/4		82820	100/500	82820J	100/1200	—	—
8-18 x 1 1/2		82824	100/500	82824J	100/1200	—	—
10-16 x 1/2	#2	83008	100/500	83008J	100/1200	—	—
10-16 x 5/8		83010	100/500	83010J	100/1200	—	—
10-16 x 3/4		83012	100/500	83012J	100/1200	83012-6	500
10-16 x 1		83016	100/500	83016J	100/1200	—	—
10-16 x 1 1/4		83020	100/500	83020J	100/1200	—	—
10-16 x 1 1/2		83024	50/250	83024J	100/600	—	—

Kits			
Part #	Description		
39507	#8 & #10 Pan Head Phillips Tek Screw Kit		
(381 Piece Kit)	Includes a #2-2" Power Bit		
	8 x 1/2" (100 Pieces)	8 x 3/4" (60 Pieces)	8 x 1" (50 Pieces)
	10 x 1/2" (80 Pieces)	10 x 3/4" (50 Pieces)	10 x 1" (40 Pieces)

▲ Contact customer service for gravity feed jar availability.

For bulk packaging, contact customer service for quantities and availability.

HEX WASHER HEAD TEK SCREWS • ZINC

		Best Merchandising Option					
		Plastic Box	Gravity Feed Jar	Job Jar			
Size	Bit Size	Part #	Box Qty/ Std Pk	Part #	Jar Qty/ Std Pk	Part #	Jar Qty
6-20 x 3/8	1/4"	78606	100/500	▲		—	
6-20 x 1/2		78608	100/500	▲		—	
6-20 x 3/4		78612	100/500	▲		—	
6-20 x 1		78616	100/500	▲		—	
8-18 x 1/2	1/4"	78808	100/500	78808J	100/1200	78808-6	1000
8-18 x 5/8		78810	100/500	78810J	100/1200	—	
8-18 x 3/4		78812	100/500	78812J	100/1200	78812-6	750
8-18 x 1		78816	100/500	78816J	100/1200	78816-6	750
8-18 x 1 1/4		78820	100/500	▲		—	
8-18 x 1 1/2		78824	100/500	78824J	100/1200	—	
10-16 x 1/2	5/16"	79008	100/500	79008J	100/1200	79008-6	750
10-16 x 5/8		79010	100/500	79010J	100/1200	—	
10-16 x 3/4		79012	100/500	79012J	100/1200	79012-6	750
10-16 x 1		79016	100/500	79016J	100/1200	79016-6	500
10-16 x 1 1/4		79020	100/500	79020J	100/600	79020-6	500
10-16 x 1 1/2		79024	50/250	79024J	100/600	79024-6	350
10-16 x 1 3/4		79028	50/250	▲		—	
10-16 x 2		79032	50/250	79032J	100/600	79032-6	250
10-16 x 2 1/2		79040	*100	▲		—	
10-16 x 3		79048	*100	79048J	100/600	—	
12-14 x 3/4	5/16"	79212	100/500	79212J	100/1200	79212-6	500
12-14 x 1		79216	100/500	79216J	100/1200	79216-6	350
12-14 x 1 1/4		79220	50/250	79220J	100/600	—	
12-14 x 1 1/2		79224	50/250	79224J	100/600	—	
12-14 x 2		79232	50/250	79232J	100/600	—	
12-14 x 2 1/2		79240	*100	79240J	100/600	—	
12-14 x 3		79248	*100	79248J	100/600	—	
1/4-14 x 3/4	3/8"	79412	100/500	79412J	100/600	—	
1/4-14 x 1		79416	50/250	79416J	100/600	—	
1/4-14 x 1 1/4		79420	50/250	▲		—	
1/4-14 x 1 1/2		79424	50/250	79424J	100/600	—	
1/4-14 x 2		79432	25/125	79432J	100/600	—	
1/4-14 x 2 1/2		79440	*100	▲		—	
1/4-14 x 3		79448	*100	▲		—	



- #6 Tek Screws feature a #1 drill point.
- #8 and #10 Tek Screws feature a #2 drill point.
- #12 and #14 Tek Screws feature a #3 drill point.

FASTENERS • SCREWS

Continued on next page.

▲ Contact customer service for gravity feed jar availability.

For bulk packaging, contact customer service for quantities and availability.

HEX WASHER HEAD TEK SCREWS • ZINC (CONT.)

Kits			
Part #	Description		
	Hex Washer Head Tek Kit		
39509 (307 Piece Kit)	8 x 1/2" (100 Pieces)	8 x 3/4" (50 Pieces)	8 x 1" (40 Pieces)
	10 x 1/2" (50 Pieces)	10 x 3/4" (35 Pieces)	10 x 1" (30 Pieces)
	1/4" Mag Tek Driver	5/16" Mag Hex Driver	

HEX WASHER HEAD TEK SCREWS • 410 STAINLESS STEEL



		Best Merchandising Option					
		Plastic Box	Gravity Feed Jar	Job Jar			
Size	Bit Size	Part #	Box Qty/ Std Pk	Part #	Jar Qty/ Std Pk	Part #	Jar Qty
6-20 x 3/8	1/4"	78606SS	100/500	78606SSJ	100/1200	—	—
6-20 x 1		78616SS	100/500	78616SSJ	100/1200	—	—
8-18 x 1/2	1/4"	78808SS	100/500	78808SSJ	100/1200	—	—
8-18 x 1		78816SS	100/500	78816SSJ	100/1200	—	—
10-16 x 1/2	5/16"	79008SS	100/500	79008SSJ	100/1200	—	—
10-16 x 1		79016SS	100/500	79016SSJ	100/1200	—	—
10-16 x 1 1/2		79024SS	50/250	79024SSJ	100/600	—	—
12-14 x 1	5/16"	79216SS	100/500	79216SSJ	100/1200	—	—
12-14 x 1 1/2		79224SS	50/250	79224SSJ	100/600	—	—

Harsh Environment Product

WAFER HEAD LATH TEK SCREWS (K-LATH) • PHILLIPS • ZINC



• Wafer head provides a larger bearing surface.

		Best Merchandising Option					
		Plastic Box	Gravity Feed Jar	Job Jar			
Size	Bit Size	Part #	Box Qty/ Std Pk	Part #	Jar Qty/ Std Pk	Part #	Jar Qty
8 x 1/2	#2	26809	100/500	26809J	100/1200	26809-6	1000
8 x 9/16		26811	100/500	26811J	100/1200	26811-6	1000
8 x 3/4		26813	100/500	26813J	100/1200	26813-6	1000
8 x 1		26817	100/500	26817J	100/1200	26817-6	500
8 x 1 1/4		26821	100/500	26821J	100/1200	26821-6	500

For bulk packaging, contact customer service for quantities and availability.

ROUND HEAD MACHINE SCREWS • PHILLIPS/SLOTTED COMBO • ZINC

		Best Merchandising Option					
		Plastic Box	Gravity Feed Jar	Job Jar			
Size	Bit Size	Part #	Box Qty/ Std Pk	Part #	Jar Qty/ Std Pk	Part #	Jar Qty
6-32 x 3/8	#2	52206	100/500	52206J	100/1200	—	—
6-32 x 1/2		52208	100/500	52208J	100/1200	52208-6	1000
6-32 x 3/4		52212	100/500	52212J	100/1200	—	—
6-32 x 1		52216	100/500	52216J	100/1200	—	—
6-32 x 1 1/4		52220	100/500	52220J	100/1200	—	—
6-32 x 1 1/2		52224	100/500	52224J	100/1200	—	—
6-32 x 2		52232	100/500	52232J	100/600	—	—
6-32 x 2 1/2		52240	*100	52240J	100/600	—	—
6-32 x 3		52248	*100	52248J	100/600	—	—
8-32 x 3/8	#2	52406	100/500	52406J	100/1200	52406-6	1000
8-32 x 1/2		52408	100/500	52408J	100/1200	52408-6	1000
8-32 x 3/4		52412	100/500	52412J	100/1200	52412-6	1000
8-32 x 1		52416	100/500	52416J	100/1200	52416-6	750
8-32 x 1 1/4		52420	100/500	52420J	100/1200	52420-6	500
8-32 x 1 1/2		52424	100/500	52424J	100/1200	52424-6	500
8-32 x 2		52432	50/250	52432J	100/600	52432-6	250
8-32 x 2 1/2		52440	*100	52440J	100/600	—	—
8-32 x 3		52448	*100	52448J	100/600	—	—
8-32 x 3 1/2 (slot only)		52356	*100	▲	—	—	—
8-32 x 4 (combo)		52364	*100	52364J	100/600	—	—
10-24 x 3/8	#2	52606	100/500	52606J	100/1200	—	—
10-24 x 1/2		52608	100/500	52608J	100/1200	—	—
10-24 x 3/4		52612	100/500	52612J	100/1200	—	—
10-24 x 1		52616	100/500	52616J	100/1200	—	—
10-24 x 1 1/4		52620	100/500	52620J	100/1200	—	—
10-24 x 1 1/2		52624	100/500	52624J	100/600	—	—
10-24 x 2		52632	50/250	52632J	100/600	—	—
10-24 x 3		52648	*100	52648J	100/600	—	—
10-32 x 1/2	#2	52809	100/500	52809J	100/1200	52809-6	1000
10-32 x 3/4		52813	100/500	52813J	100/1200	—	—
10-32 x 1		52817	100/500	52817J	100/1200	—	—
10-32 x 1 1/4		52821	100/500	52821J	100/1200	—	—
10-32 x 1 1/2		52825	100/500	52825J	100/600	—	—
10-32 x 2		52833	50/250	52833J	100/600	—	—

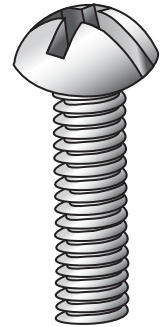

▲ Contact customer service for gravity feed jar availability.

*These items are packaged in cardboard boxes.

For bulk packaging, contact customer service for quantities and availability.

Continued on next page.

ROUND HEAD MACHINE SCREWS • PHILLIPS/SLOTTED COMBO • ZINC (CONT.)

FASTENERS • SCREWS

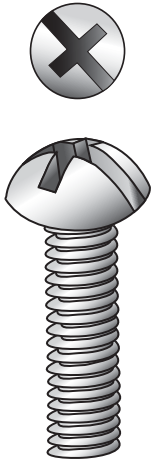

*These items are packaged in cardboard boxes.

For bulk packaging, contact customer service for quantities and availability.

		Best Merchandising Option					
		Plastic Box		Gravity Feed Jar		Job Jar	
Size	Bit Size	Part #	Box Qty/ Std Pk	Part #	Jar Qty/ Std Pk	Part #	Jar Qty
1/4-20 x 3/8	#3	53006	100/500	53006J	100/1200	53006-6	500
1/4-20 x 1/2		53008	100/500	53008J	100/1200	53008-6	500
1/4-20 x 3/4		53012	100/500	53012J	100/1200	53012-6	500
1/4-20 x 1		53016	50/250	53016J	100/600	53016-6	350
1/4-20 x 1 1/4		53020	50/250	53020J	100/600	—	—
1/4-20 x 1 1/2		53024	50/250	53024J	100/600	—	—
1/4-20 x 2		53032	25/125	53032J	100/600	—	—
1/4-20 x 2 1/2		53040	*100	53040J	100/600	—	—
1/4-20 x 3		53048	*100	53048J	100/600	—	—
1/4-20 x 4		53064	*100	53064J	100/600	—	—
3/8-16 x 3/4	#3	53212	*100	53212J	100/600	—	—
3/8-16 x 1		53216	*100	53216J	100/600	—	—
3/8-16 x 1 1/4		53220	*100	53220J	100/600	—	—
3/8-16 x 1 1/2		53224	*100	53224J	100/600	—	—
3/8-16 x 2		53232	*50	53232J	100/600	—	—
3/8-16 x 3		53248	*50	53248J	50/300	—	—
3/8-16 x 4		53264	*50	53264J	50/300	—	—

Kits			
Part #	Description		
39525 (370 Piece Kit)	6-32 Combo RH Machine Screw Kit		
	6-32 x 1/2" (100 Pieces)	6-32 x 1" (75 Pieces)	6-32 x 1 1/2" (40 Pieces)
	6-32 x 3/4" (75 Pieces)	6-32 x 1 1/4" (50 Pieces)	6-32 x 2" (30 Pieces)
39526 (310 Piece Kit)	8-32 Combo RH Machine Screw Kit		
	8-32 x 1/2" (100 Pieces)	8-32 x 1" (50 Pieces)	8-32 x 1 1/2" (35 Pieces)
	8-32 x 3/4" (60 Pieces)	8-32 x 1 1/4" (40 Pieces)	8-32 x 2" (25 Pieces)
39538 (245 Piece Kit)	10-24 Combo RH Machine Screw Kit		
	10-24 x 1/2" (75 Pieces)	10-24 x 1" (40 Pieces)	10-24 x 1 1/2" (25 Pieces)
	10-24 x 3/4" (50 Pieces)	10-24 x 1 1/4" (30 Pieces)	10-24 x 2" (25 Pieces)
39532 (245 Piece Kit)	10-32 Combo RH Machine Screw Kit		
	10-32 x 1/2" (75 Pieces)	10-32 x 1" (40 Pieces)	10-32 x 1 1/2" (25 Pieces)
	10-32 x 3/4" (50 Pieces)	10-32 x 1 1/4" (30 Pieces)	10-32 x 2" (25 Pieces)
39536 (152 Piece Kit)	1/4-20 Combo RH Machine Screw Kit		
	1/4-20 x 3/8" (40 Pieces)	1/4-20 x 3/4" (30 Pieces)	1/4-20 x 1 1/2" (15 Pieces)
	1/4-20 x 1 1/2" (35 Pieces)	1/4-20 x 1" (20 Pieces)	1/4-20 x 2" (12 Pieces)

ROUND HEAD MACHINE SCREWS • SQUARE/SLOTTED COMBO • ZINC

		Best Merchandising Option					
		Plastic Box	Gravity Feed Jar	Job Jar			
Size	Bit Size	Part #	Box Qty/ Std Pk	Part #	Jar Qty/ Std Pk	Part #	Jar Qty
6-32 x ¼	#1	22504	100/500	▲	—	—	—
6-32 x ⅜		22506	100/500	▲	—	—	—
6-32 x ½		22508	100/500	22508J	100/1200	—	—
6-32 x ¾		22512	100/500	22512J	100/1200	—	—
6-32 x 1		22516	100/500	22516J	100/1200	—	—
6-32 x 1¼		22520	100/500	22520J	100/1200	—	—
6-32 x 1½		22524	100/500	22524J	100/1200	—	—
6-32 x 2		22532	100/500	22532J	100/1200	—	—
8-32 x ⅜	#2	22606	100/500	▲	—	—	—
8-32 x ½		22608	100/500	▲	—	—	—
8-32 x ⅝		22610	100/500	▲	—	—	—
8-32 x ¾		22612	100/500	22612J	100/1200	—	—
8-32 x 1		22616	100/500	22616J	100/1200	—	—
8-32 x 1¼		22620	100/500	22620J	100/1200	—	—
8-32 x 1½		22624	100/500	22624J	100/1200	—	—
8-32 x 1¾		22628	100/500	▲	—	—	—
8-32 x 2		22632	50/250	22632J	50/600	—	—
10-24 x ½	#2	22708	100/500	▲	—	—	—
10-24 x ¾		22712	100/500	▲	—	—	—
10-24 x 1		22716	100/500	22716J	100/1200	—	—
10-24 x 1¼		22720	100/500	▲	—	—	—
10-24 x 1½		22724	100/500	22724J	100/600	—	—
10-24 x 2		22732	50/250	▲	—	—	—
10-24 x 2½		22740	*100	▲	—	—	—
10-24 x 3		22748	*100	22748J	100/600	—	—

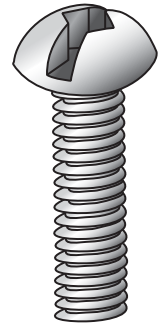

FASTENERS • SCREWS

Square drive is also considered tamperproof in some markets. For a selection of Stainless and Tamperproof Machine Screws see pages 46-49.

See pages 140-141 for Hex Power Bits.

Continued on next page.

▲ Contact customer service for gravity feed jar availability.
*These items are packaged in cardboard boxes.

For bulk packaging, contact customer service for quantities and availability.

ROUND HEAD MACHINE SCREWS • SQUARE/SLOTTED COMBO • ZINC (CONT.)

FASTENERS • SCREWS

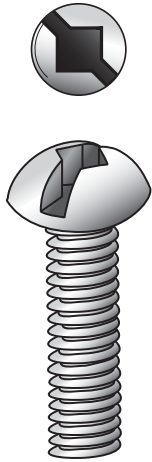

		Best Merchandising Option					
		Plastic Box		Gravity Feed Jar		Job Jar	
Size	Bit Size	Part #	Box Qty/ Std Pk	Part #	Jar Qty/ Std Pk	Part #	Jar Qty
10-32 x 1/2	#2	22808	100/500	▲			—
10-32 x 5/8		22810	100/500	▲			—
10-32 x 3/4		22812	100/500	▲			—
10-32 x 1		22816	100/500	22816J	100/1200		—
10-32 x 1 1/4		22820	100/500	▲			—
10-32 x 1 1/2		22824	100/500	▲			—
10-32 x 2		22832	50/250	▲			—
1/4-20 x 3/8	#3	23006	100/500	▲			—
1/4-20 x 1/2		23008	100/500	23008J	100/1200		—
1/4-20 x 3/4		23012	100/500	23012J	100/1200		—
1/4-20 x 1		23016	50/250	23016J	100/600		—
1/4-20 x 1 1/4		23020	50/250	23020J	100/600		—
1/4-20 x 1 1/2		23024	50/250	23024J	100/600		—
1/4-20 x 2		23032	25/125	23032J	50/300		—
1/4-20 x 2 1/2		23040	*100	▲			—



Kits

Part #	Description		
39527 (310 Piece Kit)	8-32 Round Head Square/Slotted Drive Machine Screw Kit		
	8-32 x 1/2" (100 Pieces)	8-32 x 1" (50 Pieces)	8-32 x 1 1/2" (35 Pieces)
	8-32 x 3/4" (60 Pieces)	8-32 x 1 1/4" (40 Pieces)	8-32 x 2" (25 Pieces)
39534 (245 Piece Kit)	10-32 Round Head Square/Slotted Machine Screw Kit		
	10-32 x 1/2" (75 Pieces)	10-32 x 1" (40 Pieces)	10-32 x 1 1/2" (25 Pieces)
	10-32 x 3/4" (50 Pieces)	10-32 x 1 1/4" (30 Pieces)	10-32 x 2" (25 Pieces)
39537 (152 Piece Kit)	1/4-20 Round Head Square/Slotted Machine Screw Kit		
	1/4-20 x 1/2" (40 Pieces)	1/4-20 1" (30 Pieces)	1/4-20 1 1/2" (15 Pieces)
	1/4-20 3/4" (35 Pieces)	1/4-20 1 1/4" (20 Pieces)	1/4-20 2" (12 Pieces)

▲ Contact customer service for gravity feed jar availability.
*These items are packaged in cardboard boxes.

For bulk packaging, contact customer service for quantities and availability.

ROUND HEAD MACHINE SCREWS • SLOTTED • 18-8 STAINLESS STEEL

		Best Merchandising Option					
		Plastic Box	Gravity Feed Jar	Job Jar			
Size	Bit Size	Part #	Box Qty/ Std Pk	Part #	Jar Qty/ Std Pk	Part #	Jar Qty
8-32 x 3/8	#2	52306SS	100/500	52306SSJ	100/1200	—	—
8-32 x 1/2		52308SS	100/500	52308SSJ	100/1200	—	—
8-32 x 3/4		52312SS	100/500	52312SSJ	100/1200	—	—
8-32 x 1		52316SS	100/500	52316SSJ	100/1200	—	—
10-24 x 1	#2	52516SS	100/500	52516SSJ	100/1200	—	—
10-32 x 1		52716SS	100/500	52716SSJ	100/1200	—	—
1/4-20 x 3/8	#3	52906SS	100/500	52906SSJ	100/1200	—	—
1/4-20 x 1/2		52908SS	100/500	52908SSJ	100/1200	—	—
1/4-20 x 3/4		52912SS	100/500	52912SSJ	100/1200	—	—
1/4-20 x 1		52916SS	50/250	52916SSJ	100/600	—	—
1/4-20 x 1 1/4		52920SS	50/250	52920SSJ	100/600	—	—
1/4-20 x 1 1/2		52924SS	50/250	52924SSJ	100/600	—	—

Harsh Environment Product

For bulk packaging, contact customer service for quantities and availability.



FASTENERS • SCREWS

ROUND HEAD MACHINE SCREWS • PHILLIPS • 18-8 STAINLESS STEEL

		Best Merchandising Option			
		Plastic Box	Gravity Feed Jar		
Size	Bit Size	Part #	Box Qty/ Std Pk	Part #	Jar Qty/ Std Pk
1/4-20 x 1	#3	62915SS	50/250	62915SSJ	100/600
1/4-20 x 1 1/4		62919SS	50/250	62919SSJ	100/600
1/4-20 x 1 1/2		62923SS	50/250	62923SSJ	100/600

Harsh Environment Product



FLAT HEAD MACHINE SCREWS • SQUARE DRIVE • ZINC

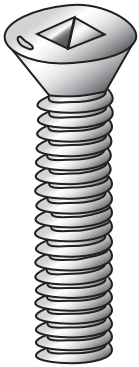

For a selection of Truss Head Machine Screws see page 37.

▲ Contact customer service for gravity feed jar availability.

*These items are packaged in cardboard boxes.

For bulk packaging, contact customer service for quantities and availability.

		Best Merchandising Option					
		Plastic Box		Gravity Feed Jar		Job Jar	
Size	Bit Size	Part #	Box Qty/Std Pk	Part #	Jar Qty/Std Pk	Part #	Jar Qty
6-32 x ¼	#1	20504	100/500	▲		—	
6-32 x ½		20508	100/500	▲		—	
6-32 x ¾		20512	100/500	▲		—	
6-32 x 1		20516	100/500	20516J	100/1200	—	
6-32 x 1¼		20520	100/500	20520J	100/1200	—	
6-32 x 1½		20524	100/500	20524J	100/1200	—	
6-32 x 2		20532	100/500	20532J	100/1200	—	
8-32 x ½	#2	20608	100/500	▲		—	
8-32 x ¾		20612	100/500	▲		—	
8-32 x 1		20616	100/500	▲		—	
8-32 x 1¼		20620	100/500	▲		—	
8-32 x 1½		20624	100/500	▲		—	
8-32 x 2		20632	50/250	▲		—	
10-24 x ½	#2	20708	100/500	▲		—	
10-24 x ¾		20712	100/500	▲		—	
10-24 x 1		20716	100/500	▲		—	
10-24 x 1¼		20720	100/500	▲		—	
10-24 x 1½		20724	100/500	20724J	100/600	—	
10-24 x 2		20732	50/250	20732J	50/300	—	
10-24 x 2½		20740	*100	▲		—	
10-24 x 3		20748	*100	▲		—	
10-32 x ½	#2	20808	100/500	▲		—	
10-32 x ¾		20812	100/500	▲		—	
10-32 x 1		20816	100/500	▲		—	
10-32 x 1¼		20820	100/500	▲		—	
¼-20 x ½	#3	21008	100/500	▲		—	
¼-20 x ¾		21012	100/500	▲		—	
¼-20 x 1		21016	50/250	▲		—	
¼-20 x 1¼		21020	50/250	▲		—	
¼-20 x 1½		21024	50/250	▲		—	
¼-20 x 2		21032	25/125	▲		—	
¼-20 x 2½		21040	*100	▲		—	
¼-20 x 3		21048	*100	▲		—	

FLAT HEAD MACHINE SCREWS • SLOTTED • ZINC

		Best Merchandising Option					
		Plastic Box	Gravity Feed Jar	Job Jar			
Size	Bit Size	Part #	Box Qty/ Std Pk	Part #	Jar Qty/ Std Pk	Part #	Jar Qty
6-32 x 1/2	#6-#8	50108	100/500	50108J	100/1200	—	—
6-32 x 3/4		50112	100/500	50112J	100/1200	—	—
6-32 x 1		50116	100/500	50116J	100/1200	—	—
6-32 x 1 1/4		50120	100/500	50120J	100/1200	—	—
6-32 x 1 1/2		50124	100/500	50124J	100/1200	—	—
6-32 x 1 3/4		50128	100/500	▲		—	—
6-32 x 2		50132	100/500	50132J	100/600	—	—
6-32 x 2 1/2		50140	*100	50140J	100/600	—	—
6-32 x 3		50148	*100	50148J	100/600	—	—
6-32 x 4		50164	*100	▲		—	—
8-32 x 3/8	#8-#10	50306	100/500	▲		—	—
8-32 x 1/2		50308	100/500	50308J	100/1200	—	—
8-32 x 3/4		50312	100/500	50312J	100/1200	—	—
8-32 x 1		50316	100/500	50316J	100/1200	—	—
8-32 x 1 1/4		50320	100/500	50320J	100/1200	—	—
8-32 x 1 1/2		50324	100/500	50324J	100/1200	—	—
8-32 x 2		50332	50/250	50332J	100/600	—	—
8-32 x 2 1/2		50340	*100	50340J	100/600	—	—
8-32 x 3		50348	*100	50348J	100/600	—	—
10-24 x 1/2	#10-#12	50508	100/500	▲		—	—
10-24 x 3/4		50512	100/500	▲		—	—
10-24 x 1		50516	100/500	▲		—	—
10-24 x 1 1/4		50520	100/500	▲		—	—
10-24 x 1 1/2		50524	100/500	▲		—	—
10-24 x 2		50532	50/250	▲		—	—
10-24 x 2 1/2		50540	*100	▲		—	—
10-24 x 3		50548	*100	▲		—	—
10-32 x 1/2	#10-#12	50708	100/500	▲		—	—
10-32 x 3/4		50712	100/500	▲		—	—
10-32 x 1		50716	100/500	50716J	100/1200	—	—
10-32 x 1 1/4		50720	100/500	▲		—	—
10-32 x 1 1/2		50724	100/500	▲		—	—
10-32 x 2		50732	50/250	▲		—	—
10-32 x 2 1/2		50740	*100	▲		—	—
10-32 x 3		50748	*100	▲		—	—
1/4-20 x 1/2	#12-#14	50908	100/500	▲		—	—
1/4-20 x 3/4		50912	100/500	▲		—	—
1/4-20 x 1		50916	50/250	50916J	100/600	—	—
1/4-20 x 1 1/4		50920	50/250	50920J	100/600	—	—
1/4-20 x 1 1/2		50924	50/250	50924J	100/600	—	—
1/4-20 x 2		50932	25/125	▲		—	—
1/4-20 x 2 1/2		50940	*100	▲		—	—
1/4-20 x 3		50948	*100	50948J	100/600	—	—



▲ Contact customer service for gravity feed jar availability.

*These items are packaged in cardboard boxes.

For bulk packaging, contact customer service for quantities and availability.

FLAT HEAD MACHINE SCREWS • SLOTTED • ZINC (CONT.)



Kits			
Part #	Description		
39541 (415 Piece Kit)	6-32 Flat Head Slot Machine Screw Kit		
	6-32 x 1/2" (100 Pieces)	6-32 x 1" (75 Pieces)	6-32 x 1 1/2" (45 Pieces)
	6-32 x 3/4" (100 Pieces)	6-32 x 1 1/4" (55 Pieces)	6-32 x 2" (40 Pieces)

FLAT HEAD MACHINE SCREWS • SLOTTED • 18-8 STAINLESS STEEL



		Best Merchandising Option					
		Plastic Box		Gravity Feed Jar		Job Jar	
Size	Bit Size	Part #	Box Qty/ Std Pk	Part #	Jar Qty/ Std Pk	Part #	Jar Qty
6-32 x 3/4"	#1	60112SS	100/500	60112SSJ	100/1200	—	—
6-32 x 1"		60116SS	100/500	60116SSJ	100/1200	—	—
6-32 x 1 1/2"		60124SS	100/500	60124SSJ	100/1200	—	—
6-32 x 2"		60132SS	100/500	60132SSJ	100/600	—	—

Harsh Environment Product

FLAT HEAD MACHINE SCREWS • PHILLIPS • ZINC



		Best Merchandising Option					
		Plastic Box		Gravity Feed Jar		Job Jar	
Size	Bit Size	Part #	Box Qty/ Std Pk	Part #	Jar Qty/ Std Pk	Part #	Jar Qty
6-32 x 1/2"	#1	50109	100/500	50109J	100/1200	—	—
6-32 x 3/4"		50113	100/500	50113J	100/1200	—	—
6-32 x 1"		50117	100/500	50117J	100/1200	—	—
6-32 x 1 1/4"		50121	100/500	50121J	100/1200	—	—
6-32 x 1 1/2"		50125	100/500	50125J	100/1200	—	—
6-32 x 2"		50133	100/500	50133J	100/600	—	—
6-32 x 2 1/2"		50141	*100	50141J	100/600	—	—
6-32 x 3"		50149	*100	50149J	100/600	—	—
8-32 x 1 1/2"		50325	100/500	▲		—	—

▲ Contact customer service for gravity feed jar availability.
*These items are packaged in cardboard boxes.

For bulk packaging, contact customer service for quantities and availability.

TRUSS HEAD MACHINE SCREWS • PHILLIPS/SLOTTED • ZINC

• Designed for use with receptacles.

		Best Merchandising Option					
		Plastic Box	Gravity Feed Jar	Job Jar			
Size	Bit Size	Part #	Box Qty/ Std Pk	Part #	Jar Qty/ Std Pk	Part #	Jar Qty
6-32 x 1/2	#2	52008	100/500	52008J	100/1200	—	—
6-32 x 3/4		52012	100/500	52012J	100/1200	—	—
6-32 x 1		52016	100/500	52016J	100/1200	52016-6	750
6-32 x 1 1/4		52020	100/500	52020J	100/1200	—	—
6-32 x 1 1/2		52024	100/500	52024J	100/1200	52024-6	500
6-32 x 2		52032	100/500	52032J	100/600	52032-6	350
6-32 x 3		52048	*100	▲		—	—
6-32 x 4		52064	*100	▲		—	—
10-24 x 2	#2	52133	*100	▲		—	—
10-24 x 3		52149	*100	▲		—	—
10-24 x 4		52165	*100	▲		—	—
1/4-20 x 3	#3	52249	*100	▲		—	—
1/4-20 x 4		52265	*100	▲		—	—

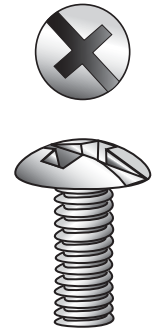

FASTENERS • SCREWS

Kits				
Part #	Description			
39546 (380 Piece Kit)	6-32 Truss Head Machine Screw Combo Kit			
	1/2" (100 Pieces)	1" (65 Pieces)	1 1/2" (40 Pieces)	
	3/4" (90 Pieces)	1 1/4" (50 Pieces)	2" (35 Pieces)	

TRUSS HEAD MACHINE SCREWS • SQUARE/SLOTTED • ZINC

		Best Merchandising Option					
		Plastic Box	Gravity Feed Jar	Job Jar			
Size	Bit Size	Part #	Box Qty	Part #	Jar Qty/ Std Pk	Part #	Jar Qty
6-32 x 2	#1	24433	100	▲		—	—
6-32 x 3		24449 ★	*100	▲		—	—
6-32 x 4		24465 ★	*100	▲		—	—
8-32 x 1/2	#2	24608	100/500	▲		—	—
10-24 x 2	#2	24733	100	▲		—	—
10-24 x 3		24749	*100	▲		—	—
10-24 x 4		24765	*100	▲		—	—
1/4-20 x 3	#3	25049	*100	▲		—	—
1/4-20 x 4		25065	*100	▲		—	—

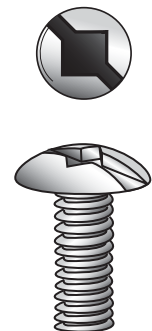

▲ Contact customer service for gravity feed jar availability.

*These items are packaged in cardboard boxes.

★ Made in USA

For bulk packaging, contact customer service for quantities and availability.

WALL PLATE SCREWS • SLOTTED • 6-32 OVAL HEAD



▲ Contact customer service for gravity feed jar availability.

🛡️ Harsh Environment Product

For bulk packaging, contact customer service for quantities and availability.

		Best Merchandising Option					
		📦 Plastic Box		🏺 Gravity Feed Jar		🏺 Job Jar	
Length	Color	Part #	Box Qty/ Std Pk	Part #	Jar Qty/ Std Pk	Part #	Jar Qty
5/16"	White	51104	100/500	51104J	100/1200	—	—
1/2"	White	51109	100/500	51109J	100/1200	—	—
3/4"	White	51113	100/500	51113J	100/1200	—	—
1"	White	51117	100/500	51117J	100/1200	—	—
5/16"	Ivory	51105	100/500	51105J	100/1200	—	—
1/2"	Ivory	51108	100/500	51108J	100/1200	—	—
3/4"	Ivory	51112	100/500	51112J	100/1200	—	—
1"	Ivory	51116	100/500	51116J	100/1200	—	—
5/16"	Lt. Almd	51103	100/500	51103J	100/1200	—	—
1/2"	Lt. Almd	51107	100/500	51107J	100/1200	—	—
3/4"	Lt. Almd	51111	100/500	▲	—	—	—
1"	Lt. Almd	51115	100/500	▲	—	—	—
1/2"	Brown	51110	100/500	51110J	100/1200	—	—
3/4"	Brown	51114	100/500	▲	—	—	—
1"	Brown	51118	100/500	▲	—	—	—
1/2"	Stainless	53608 🛡️	100/500	53608J 🛡️	100/1200	—	—
3/4"	Stainless	53612 🛡️	100/500	▲	—	—	—
1"	Stainless	53616 🛡️	100/500	▲	—	—	—
1/2"	Nyln Ivry	53708	100/500	▲	—	—	—
3/4"	Nyln Ivry	53712	100/500	▲	—	—	—
1"	Nyln Ivry	53716	100/500	53716J	100/1200	—	—
1/2"	Nyln Wht	53808	100/500	▲	—	—	—
3/4"	Nyln Wht	53812	100/500	▲	—	—	—



Kits

Part #	Description					
39515 (600 Piece Kit)	White & Ivory Wall Plate Screw Kit					
	5/16" White (100 Pieces)	1/2" White (100 Pieces)	3/4" White (100 Pieces)			
	5/16" Ivory (100 Pieces)	1/2" Ivory (100 Pieces)	3/4" Ivory (100 Pieces)			
39514 (300 Piece Kit)	Light Almond Wall Plate Screw Kit					
	5/16" Lt. Almond (75 Pieces)	3/4" Lt. Almond (75 Pieces)				
	1/2" Lt. Almond (75 Pieces)	1" Lt. Almond (75 Pieces)				
39508 (300 Piece Kit)	Residential Wall Plate Screw Kit					
	1/2" Wall Plate					
	White (50 Pieces)		Ivory (50 Pieces)		Light Almond (50 Pieces)	
	5/16" Decora					
White (50 Pieces)		Ivory (50 Pieces)		Light Almond (50 Pieces)		

All kits are standard packed 5 units per sleeve.

FLAT HEAD WOOD SCREWS • SQUARE DRIVE • ZINC

		Best Merchandising Option					
		Plastic Box	Gravity Feed Jar	Job Jar			
Size	Bit Size	Part #	Box Qty/ Std Pk	Part #	Jar Qty/ Std Pk	Part #	Jar Qty
4 x 3/8**	#0	12406	100/500	▲		—	
4 x 1/2**		12408	100/500	▲		—	
4 x 3/4**		12412	100/500	12412J	100/1200	—	
4 x 1**		12416	100/500	12416J	100/1200	—	
5 x 3/4**	#1	12512	100/500	▲		—	
6 x 1/2**	#1	12608	100/500	12608J	100/1200	—	
6 x 5/8**		12610	100/500	▲		—	
6 x 3/4**		12612	100/500	12612J	100/1200	—	
6 x 1**		12616	100/500	12616J	100/1200	—	
6 x 1 1/4		12620	100/500	▲		—	
6 x 1 1/2		12624	100/500	▲		—	
6 x 1 3/4		12628	100/500	▲		—	
6 x 2		12632	100/500	▲		—	
8 x 1/2**	#2	12808	100/500	12808J	100/1200	—	
8 x 5/8**		12810	100/500	12810J	100/1200	—	
8 x 3/4**		12812	100/500	12812J	100/1200	—	
8 x 1**		12816	100/500	12816J	100/1200	—	
8 x 1 1/4		12820	100/500	▲		—	
8 x 1 1/2		12824	100/500	12824J	100/1200	—	
8 x 1 3/4		12828	100/500	▲		—	
8 x 2		12832	50/250	12832J	50/600	—	
8 x 2 1/2		12840	*100	▲		—	
8 x 3		12848	*100	▲		—	
8 x 3 1/2		12856	*100	▲		—	
8 x 4		12864	*100	▲		—	
10 x 1/2**	#2	13008	100/500	▲		—	
10 x 3/4**		13012	100/500	13012J	100/1200	—	
10 x 1**		13016	100/500	13016J	100/1200	—	
10 x 1 1/4	#2	13020	100/500	13020J	100/1200	—	
10 x 1 1/2		13024	50/250	13024J	100/600	—	
10 x 1 3/4		13028	50/250	▲		—	
10 x 2		13032	50/250	13032J	100/600	—	
10 x 2 1/4		13036	*100	▲		—	
10 x 2 1/2		13040	*100	▲		—	
10 x 3		13048	*100	▲		—	

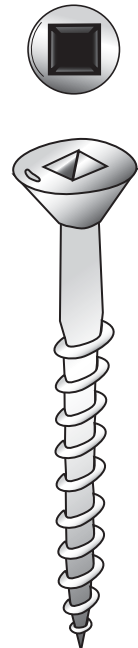

FASTENERS • SCREWS

▲ Contact customer service for gravity feed jar availability.

*These items are packaged in cardboard boxes.

**These sizes are fully threaded.

For bulk packaging, contact customer service for quantities and availability.

Continued on next page.

FLAT HEAD WOOD SCREWS • SQUARE DRIVE • ZINC (CONT.)

FASTENERS • SCREWS

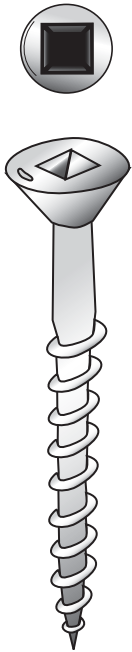

		Best Merchandising Option					
		Plastic Box		Gravity Feed Jar		Job Jar	
Size	Bit Size	Part #	Box Qty/ Std Pk	Part #	Jar Qty/ Std Pk	Part #	Jar Qty
10 x 3½		13056	*100	▲		—	
10 x 4		13064	*100	▲		—	
12 x ¾**	#3	13212	100/500	▲		—	
12 x 1**		13216	100/500	▲		—	
12 x 1¼		13220	50/250	▲		—	
12 x 1½		13224	50/250	▲		—	
12 x 2		13232	50/250	▲		—	
12 x 2½		13240	*100	▲		—	
12 x 3		13248	*100	▲		—	
12 x 3½		13256	*100	▲		—	
12 x 4		13264	*100	▲		—	
14 x ¾**	#3	13412	100/500	▲		—	
14 x 1**		13416	50/250	▲		—	
14 x 1¼		13420	50/250	▲		—	
14 x 1½		13424	50/250	▲		—	
14 x 2		13432	25/125	▲		—	
14 x 2½		13440	*100	▲		—	
14 x 3		13448	*100	▲		—	
14 x 3½		13456	*100	▲		—	
14 x 4		13464	*100	▲		—	

		Kits			
Part #	Description				
39554 (316 Piece Kit)	#8 Flat Head Wood Screw Kit Includes a #2-2" Power Bit				
	8 x ½" (100 Pieces)	8 x 1" (50 Pieces)	8 x 1½" (35 Pieces)		
	8 x ¾" (60 Pieces)	8 x 1¼" (40 Pieces)	8 x 2" (30 Pieces)		
39555 (231 Piece Kit)	#10 Flat Head Wood Screw Kit Includes a #2-2" Power Bit				
	10 x ½" (70 Pieces)	10 x 1" (35 Pieces)	10 x 1½" (25 Pieces)		
	10 x ¾" (50 Pieces)	10 x 1¼" (30 Pieces)	10 x 2" (20 Pieces)		

▲ Contact customer service for gravity feed jar availability.
 *These items are packaged in cardboard boxes.
 **These sizes are fully threaded.

For bulk packaging, contact customer service for quantities and availability.

TRIM HEAD WOOD SCREWS • SQUARE DRIVE • BLACK FINISH

		Best Merchandising Option							
		Plastic Box	Gravity Feed Jar	Job Jar	1lb Boxes				
Size	Bit Size	Part #	Box Qty/ Std Pk	Part #	Jar Qty/ Std Pk	Part #	Jar Qty	Part #	Box Qty
6 x 1	#1	13716	100/500	▲	—	—	—	137161lb	418
6 x 1 ⁵ / ₈		13726	100/500	▲	—	—	—	137261lb	242
6 x 2 ¹ / ₄		13736	*100	▲	—	—	—	137361lb	187
8 x 3	#2	13748	*100	▲	—	—	—	137481lb	97



Quantities for 1lb boxes are approximate.

TRIM HEAD WOOD SCREWS • SQUARE DRIVE • STAINLESS STEEL

		Best Merchandising Option					
		Cardboard Box	Gravity Feed Jar	Job Jar			
Size	Bit Size	Part #	Box Qty/ Std Pk	Part #	Jar Qty/ Std Pk	Part #	Jar Qty
7 x 1 ⁵ / ₈	#1	72726 ♡	100/500	▲	—	—	—
7 x 2 ¹ / ₄		72736 ♡	100/500	▲	—	—	—
7 x 3		72748 ♡	100/500	▲	—	—	—

♡ Harsh Environment Product

DEEP THREAD FLAT HEAD PARTICLE BOARD SCREWS • SQUARE DRIVE • ZINC

Deep thread particle board screws are characterized by wider-spaced threads set deeper than a typical wood screw.

- #8 and #10 particle board screws require a #2 square drive bit.

		Best Merchandising Option					
		Plastic Box	Gravity Feed Jar	Job Jar			
Size	Bit Size	Part #	Box Qty/ Std Pk	Part #	Jar Qty/ Std Pk	Part #	Jar Qty
8 x 3 ⁴ / ₈	#2	13814	100/500	▲	—	—	—
8 x 1		13815	50/250	▲	—	—	—
8 x 1 ¹ / ₄		13822	50/250	▲	—	—	—
8 x 1 ¹ / ₂		13826	50/250	▲	—	—	—
8 x 1 ³ / ₄		13830	*100	▲	—	—	—
8 x 2		13834	*100	▲	—	—	—
8 x 2 ¹ / ₄		13838	*100	▲	—	—	—
8 x 2 ¹ / ₂		13842	*100	13842J	100/600	—	—
8 x 3		13850	*100	▲	—	—	—
10 x 1 ¹ / ₄	#2	14022	100/500	▲	—	—	—
10 x 1 ¹ / ₂		14026	50/250	▲	—	—	—
10 x 1 ³ / ₄		14030	50/250	▲	—	—	—
10 x 2 ¹ / ₄		14038	*100	▲	—	—	—



Continued on next page.

▲ Contact customer service for gravity feed jar availability.
*These items are packaged in cardboard boxes.

For bulk packaging, contact customer service for quantities and availability.

DEEP THREAD FLAT HEAD PARTICLE BOARD SCREWS • SQUARE DRIVE • ZINC (CONT.)

FASTENERS • SCREWS



Kits				
Part #	Description			
39548 (241 Piece Kit)	#8 Deep Thread Particle Board Screw Kit Includes a #2-2" Power Bit			
	8 x 1/2" (60 Pieces)	8 x 1 1/4" (40 Pieces)	8 x 1 3/4" (30 Pieces)	
	8 x 1" (50 Pieces)	8 x 1 1/2" (30 Pieces)	8 x 2" (30 Pieces)	

▲ Contact customer service for gravity feed jar availability.
*These items are packaged in cardboard boxes.

For bulk packaging, contact customer service for quantities and availability.

DEEP THREAD FLAT HEAD PARTICLE BOARD SCREWS • SQUARE DRIVE • BLACK



		Best Merchandising Option					
		Plastic Box		Gravity Feed Jar		Job Jar	
Size	Bit Size	Part #	Box Qty/ Std Pk	Part #	Jar Qty/ Std Pk	Part #	Jar Qty
6 x 1	#1	13616	100/500	▲			—
6 x 1 1/2		13624	100/500	▲			—
6 x 2		13632	100/500	▲			—
8 x 3/4	#2	13812	100/500	13812J	100/1200		—
8 x 1		13816	100/500	▲			—
8 x 1 1/4		13820	100/500	13820J	100/1200		—
8 x 1 1/2		13824	100/500	13824J	100/1200		—
8 x 1 3/4		13828	100/500	▲			—
8 x 2		13832	50/250	13832J	50/600		—
8 x 2 1/4		13836	*100	▲			—
8 x 2 1/2		13840	*100	13840J	100/600		—
8 x 3		13848	*100	▲			—
10 x 1	#2	14016	100/500	▲			—
10 x 1 1/4		14020	100/500	▲			—
10 x 1 1/2		14024	50/250	▲			—
10 x 1 3/4		14028	50/250	▲			—
10 x 2		14032	50/250	▲			—
10 x 2 1/4		14036	*100	▲			—
10 x 2 1/2		14040	*100	▲			—
10 x 3		14048	*100	▲			—

▲ Contact customer service for gravity feed jar availability.

*These items are packaged in cardboard boxes.

For bulk packaging, contact customer service for quantities and availability.

FINE THREAD BUGLE HEAD DRYWALL SCREWS • PHILLIPS • BLACK

- Symmetrical thread.
- Ideal for metal stud applications up to 20 gauge.
- Contact customer service for quantities and availability.



		Best Merchandising Option					
		Plastic Box	Gravity Feed Jar	Job Jar			
Size	Bit Size	Part #	Box Qty/ Std Pk	Part #	Jar Qty/ Std Pk	Part #	Jar Qty
6 x 1	#2	79616	100/500	79616J	100/1200	—	—
6 x 1 $\frac{1}{8}$		79618	100/500	79618J	100/1200	—	—
6 x 1 $\frac{1}{4}$		79624	100/500	79624J	100/1200	79624-6	500
6 x 1 $\frac{5}{8}$		79626	100/500	79626J	100/1200	79626-6	500
6 x 2		79632	50/250	79632J	100/600	79632-6	350
6 x 2 $\frac{1}{4}$		79636	*100	79636J	100/600	—	—
8 x 2 $\frac{1}{2}$	#2	79840	*100	79840J	100/600	—	—
8 x 3		79848	*100	79848J	100/600	—	—
10 x 4	#2	79964	*100	▲		—	—
10 x 4 $\frac{1}{2}$		79972	*100	▲		—	—
10 x 5		79980	*100	▲		—	—

FINE THREAD BUGLE HEAD DRYWALL TEK SCREWS • PHILLIPS • BLACK

- #6 Tek has a #1 point.
- #8 Tek has a #2 point.
- Ideal for metal studs up to 12 gauge.



		Best Merchandising Option					
		Plastic Box	Gravity Feed Jar	Job Jar			
Size	Bit Size	Part #	Box Qty/ Std Pk	Part #	Jar Qty/ Std Pk	Part #	Jar Qty
6 x 1 $\frac{1}{4}$	#2	79623	100/500	79623J	100/1200	—	—
6 x 1 $\frac{5}{8}$		79627	100/500	79627J	100/1200	—	—
6 x 1 $\frac{7}{8}$		79630	100/500	79630J	100/1200	—	—
8 x 2 $\frac{5}{8}$	#2	79845	*100	▲		—	—
8 x 3		79850	*100	▲		—	—

▲ Contact customer service for gravity feed jar availability.

*These items are packaged in cardboard boxes.

For bulk packaging, contact customer service for quantities and availability.

COARSE THREAD BUGLE HEAD DRYWALL SCREWS • PHILLIPS • BLACK

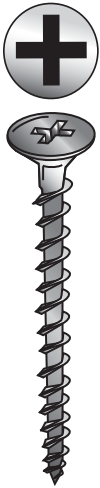

		Best Merchandising Option					
		Plastic Box		Gravity Feed Jar		Job Jar	
Size	Bit Size	Part #	Box Qty/ Std Pk	Part #	Jar Qty/ Std Pk	Part #	Jar Qty
6 x 1	#2	79617	100/500	79617J	100/1200	—	—
6 x 1½		79619	100/500	79619J	100/1200	—	—
6 x 1¼		79625	100/500	79625J	100/1200	79625-6	500
6 x 1⅝		79628	100/500	79628J	100/1200	79628-6	500
6 x 2		79634	50/250	79634J	100/600	79634-6	350
8 x 2½	#2	79841	*100	79841J	100/600	—	—
8 x 3		79849	*100	79849J	100/600	—	—

For bulk packaging, contact customer service for quantities and availability.

		Kits			
Part #	Description				
39564	Black Coarse Drywall Screw Kit Includes a #2-2" Power Bit				
(221 Piece Kit)	6 x 1¼" (100 Pieces)	6 x 1⅝" (70 Pieces)	6 x 2" (50 Pieces)		

▲ Contact customer service for gravity feed jar availability. *These items are packaged in cardboard boxes.

COARSE THREAD BUGLE HEAD DRYWALL SCREWS • PHILLIPS • YELLOW ZINC

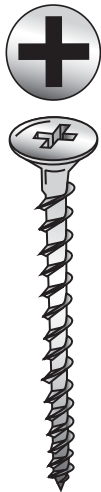

		Best Merchandising Option					
		Plastic Box		Gravity Feed Jar		Job Jar	
Size	Bit Size	Part #	Box Qty/ Std Pk	Part #	Jar Qty/ Std Pk	Part #	Jar Qty
6 x 1	#2	79620	100/500	79620J	100/1200	79620-6	500
6 x 1¼		79622	100/500	79622J	100/1200	79622-6	500
6 x 1⅝		79629	100/500	79629J	100/1200	79629-6	500
6 x 2		79635	50/250	79635J	100/600	79635-6	350
6 x 2¼		79637	*100	79637J	100/600	79637-6	250
8 x 2½	#2	79843	*100	79843J	100/600	79843-6	250
8 x 3		79851	*100	79851J	100/600	79851-6	150
10 x 4	#2	79965	*100	▲		—	
10 x 5		79981	*100	▲		—	
10 x 6		79997	*100	▲		—	

For bulk packaging, contact customer service for quantities and availability.

		Kits			
Part #	Description				
39563	Yellow Zinc Drywall Screw Kit Includes a #2-2" Power Bit				
(221 Piece Kit)	6 x 1¼" (100 Pieces)	6 x 1⅝" (70 Pieces)	6 x 2" (50 Pieces)		

▲ Contact customer service for gravity feed jar availability. *These items are packaged in cardboard boxes.

WOODEX® ALL-WEATHER DECK SCREWS • SQUARE DRIVE

- Wood chip cutting point.
- Corrosion resistant.
- Mechanical galvanized.
- Includes a #2-2 square drive power bit.

Size	Bit Size	1lb Boxes		5lb Boxes		Job Jar	
		Part #	Box Qty/ Std Pk	Part #	Box Qty/ Std Pk	Part #	Jar Qty
7 x 1¼	#2	180201lb	246	180205lb	1230	18020-6	750
8 x 1½	#2	180221lb	180	180225lb	900	18022-6	500
8 x 1¾		180261lb	161	180265lb	805	18026-6	500
9 x 2	#2	181321lb	110	181325lb	550	18132-6	250
9 x 2½		181401lb	94	181405lb	470	18140-6	200
9 x 3		181481lb	76	181485lb	380	18148-6	150
10 x 4	#2	182641lb	50	182645lb	250	18264-6	100
10 x 5		182801lb	40	182805lb	200	—	
10 x 6		182961lb	33	182965lb	165	—	

Quantities for 1lb and 5lb boxes are approximate.

Harsh Environment Product

For bulk packaging, contact customer service for quantities and availability.

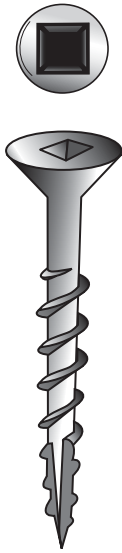

Type 17 Point

PAN, FLAT & OVAL HEAD SPANNER HEAD SHEET METAL SCREWS • STAINLESS STEEL

FASTENERS • SCREWS

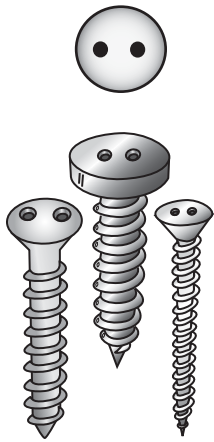

• Tamperproof screws are available by special order only, are subject to minimum order requirements and are non-returnable. Please allow an extra 5–7 days shipping.

		Cardboard Box			
Size	Insert Driver	Pan Head Spanner	Flat Head Spanner	Oval Head Spanner	Box Qty
6 x 3/8	#6 Spanner	10606TP ★ ♡	12606TP ★ ♡	—	100
6 x 1/2		10608TP ★ ♡	12608TP ★ ♡	14608TP ★ ♡	100
6 x 5/8		10610TP ★ ♡	12610TP ★ ♡	—	100
6 x 3/4		10612TP ★ ♡	12612TP ★ ♡	14612TP ★ ♡	100
6 x 1		10616TP ★ ♡	12616TP ★ ♡	14616TP ★ ♡	100
6 x 1 1/4		10620TP ★ ♡	12620TP ★ ♡	14620TP ★ ♡	100
6 x 1 1/2		10624TP ★ ♡	12624TP ★ ♡	14624TP ★ ♡	100
6 x 2		10632TP ★ ♡	12632TP ★ ♡	—	100
8 x 3/8	#8 Spanner	10806TP ★ ♡	12806TP ★ ♡	—	100
8 x 1/2		10808TP ★ ♡	12808TP ★ ♡	14808TP ★ ♡	100
8 x 3/4		10812TP ★ ♡	12812TP ★ ♡	14812TP ★ ♡	100
8 x 1		10816TP ★ ♡	12816TP ★ ♡	14816TP ★ ♡	100
8 x 1 1/4		10820TP ★ ♡	12820TP ★ ♡	14820TP ★ ♡	100
8 x 1 1/2		10824TP ★ ♡	12824TP ★ ♡	14824TP ★ ♡	100
8 x 2		10832TP ★ ♡	12832TP ★ ♡	—	100
10 x 1/2	#10 Spanner	11008TP ★ ♡	13008TP ★ ♡	15008TP ★ ♡	100
10 x 5/8		11010TP ★ ♡	13010TP ★ ♡	15010TP ★ ♡	100
10 x 3/4		11012TP ★ ♡	13012TP ★ ♡	15012TP ★ ♡	100
10 x 1		11016TP ★ ♡	13016TP ★ ♡	15016TP ★ ♡	100
10 x 1 1/4		11020TP ★ ♡	13020TP ★ ♡	15020TP ★ ♡	100
10 x 1 1/2		11024TP ★ ♡	13024TP ★ ♡	15024TP ★ ♡	100
10 x 2		11032TP ★ ♡	13032TP ★ ♡	—	100
12 x 1/2	#12 Spanner	11208TP ★ ♡	13208TP ★ ♡	—	100
12 x 3/4		11212TP ★ ♡	13212TP ★ ♡	—	100
12 x 1		11216TP ★ ♡	13216TP ★ ♡	—	100
12 x 1 1/4		11220TP ★ ♡	13220TP ★ ♡	—	100
12 x 1 1/2		11224TP ★ ♡	13224TP ★ ♡	—	100
12 x 2		11232TP ★ ♡	13232TP ★ ♡	—	100
14 x 1/2	#14 Spanner	11408TP ★ ♡	13408TP ★ ♡	—	100
14 x 3/4		11412TP ★ ♡	13412TP ★ ♡	—	100
14 x 1		11416TP ★ ♡	13416TP ★ ♡	—	100
14 x 1 1/4		11420TP ★ ♡	13420TP ★ ♡	—	100

Tamperproof Driver Bits Available on page 138



Get a 16-in-1 Tamperproof Screwdriver!

Part #37011. See page 135 for details.

★ Made in USA
♡ Harsh Environment Product

For bulk packaging, contact customer service for quantities and availability.

BUTTON HEAD SOCKET PIN SHEET METAL SCREWS • STAINLESS STEEL

- Tamperproof screws are available by special order only, are subject to minimum order requirements and are non-returnable. Please allow an extra 5–7 days shipping.

		Cardboard Box	
Size	Driver	Part #	Box Qty
8 x 3/4	1/8	10812SP ★ ♡	100
8 x 1		10816SP ★ ♡	100
10 x 1/2	5/32	11008SP ★ ♡	100
10 x 3/4		11012SP ★ ♡	100
10 x 1		11016SP ★ ♡	100

★ Made in USA ♡ Harsh Environment Product



BUTTON HEAD STAR PIN SHEET METAL SCREWS • STAINLESS STEEL

		Cardboard Box	
Size	Driver	Part #	Box Qty
8 x 1/2	T-15H	10808XP ★ ♡	100
8 x 3/4		10812XP ★ ♡	100
8 x 1		10816XP ★ ♡	100
8 x 1 1/4		10820XP ★ ♡	100
10 x 1/2	T-25H	11008XP ★ ♡	100
10 x 3/4		11012XP ★ ♡	100
10 x 1		11016XP ★ ♡	100
10 x 1 1/4		11020XP ★ ♡	100
10 x 1 1/2		11024XP ★ ♡	100

★ Made in USA ♡ Harsh Environment Product

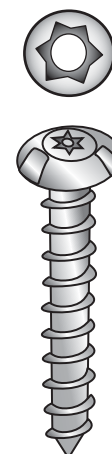

FLAT HEAD STAR PIN SHEET METAL SCREWS • STAINLESS STEEL

		Cardboard Box	
Size	Driver	Part #	Box Qty
8 x 3/4	T-15H	12812XP ★ ♡	100
8 x 1		12816XP ★ ♡	100
8 x 1 1/4		12820XP ★ ♡	100
10 x 3/4	T-20H	13012XP ★ ♡	100
10 x 1		13016XP ★ ♡	100
10 x 1 1/4		13020XP ★ ♡	100

★ Made in USA ♡ Harsh Environment Product

For bulk packaging, contact customer service for quantities and availability.

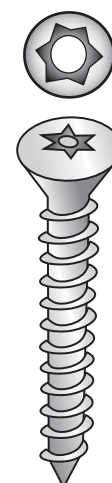

PAN, FLAT & OVAL SPANNER HEAD MACHINE SCREWS • STAINLESS STEEL

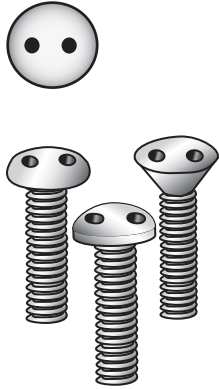

- Tamperproof screws are available by special order only, are subject to minimum order requirements and are non-returnable. Please allow an extra 5–7 days shipping.

		Cardboard Box			
Size	Insert Driver	Pan Head Part #	Flat Head Part #	Oval Head Part #	Box Qty
6-32 x 3/8	#6 Spanner	22506TP ★ ♡	20506TP ★ ♡	25606TP ★ ♡	100
6-32 x 1/2		22508TP ★ ♡	20508TP ★ ♡	25608TP ★ ♡	100
6-32 x 3/4		22512TP ★ ♡	20512TP ★ ♡	25612TP ★ ♡	100
6-32 x 1		22516TP ★ ♡	20516TP ★ ♡	25616TP ★ ♡	100
6-32 x 1 1/4		22520TP ★ ♡	20520TP ★ ♡	25620TP ★ ♡	100
6-32 x 1 1/2		22524TP ★ ♡	20524TP ★ ♡	25624TP ★ ♡	100
6-32 x 2		22532TP ★ ♡	20532TP ★ ♡	—	100
8-32 x 3/8	#8 Spanner	22606TP ★ ♡	20606TP ★ ♡	—	100
8-32 x 1/2		22608TP ★ ♡	20608TP ★ ♡	25808TP ★ ♡	100
8-32 x 3/4		22612TP ★ ♡	20612TP ★ ♡	25812TP ★ ♡	100
8-32 x 1		22616TP ★ ♡	20616TP ★ ♡	25816TP ★ ♡	100
8-32 x 1 1/4		22620TP ★ ♡	20620TP ★ ♡	25820TP ★ ♡	100
8-32 x 1 1/2		22624TP ★ ♡	20624TP ★ ♡	25824TP ★ ♡	100
8-32 x 2		22632TP ★ ♡	20632TP ★ ♡	—	100
10-24 x 1/2	#10 Spanner	22708TP ★ ♡	20708TP ★ ♡	26008TP ★ ♡	100
10-24 x 5/8		22710TP ★ ♡	20710TP ★ ♡	26010TP ★ ♡	100
10-24 x 3/4		22712TP ★ ♡	20712TP ★ ♡	26012TP ★ ♡	100
10-24 x 1		22716TP ★ ♡	20716TP ★ ♡	26016TP ★ ♡	100
10-24 x 1 1/4		22720TP ★ ♡	20720TP ★ ♡	26020TP ★ ♡	100
10-24 x 1 1/2		22724TP ★ ♡	20724TP ★ ♡	26024TP ★ ♡	100
10-24 x 2		22732TP ♡	20732TP ★ ♡	—	100
10-32 x 1/2	#10 Spanner	22808TP ★ ♡	20808TP ★ ♡	26208TP ★ ♡	100
10-32 x 3/4		22812TP ★ ♡	20812TP ★ ♡	26212TP ★ ♡	100
10-32 x 1		22816TP ★ ♡	20816TP ★ ♡	26216TP ★ ♡	100

- ★ Made in USA
- ♡ Harsh Environment Product

For bulk packaging, contact customer service for quantities and availability.

FLAT & BUTTON HEAD SOCKET PIN MACHINE SCREWS • STAINLESS STEEL

- Tamperproof screws are available by special order only, are subject to minimum order requirements and are non-returnable. Please allow an extra 5–7 days shipping.

Flat Head		Cardboard Box	
Size	Bit	Part #	Box Qty
6-32 x 3/8	1/8	20506SP	100
6-32 x 1/2		20508SP	100
6-32 x 3/4		20512SP	100
6-32 x 1		20516SP	100
8-32 x 3/8	1/8	20606SP	100
8-32 x 1/2		20608SP	100
8-32 x 3/4		20612SP	100
8-32 x 1		20616SP	100
10-24 x 3/8	5/32	20706SP	100
10-24 x 1/2		20708SP	100
10-24 x 3/4		20712SP	100
10-24 x 1		20716SP	100
10-24 x 1 1/2		20724SP	100
10-32 x 1/2	5/32	20808SP	100
10-32 x 3/4		20812SP	100
10-32 x 1		20816SP	100
10-32 x 1 1/2		20824SP	100
1/4-20 x 1/2	5/32	21008SP	100
1/4-20 x 3/4		21012SP	100
1/4-20 x 1		21016SP	100
1/4-20 x 1 1/4		21020SP	100
1/4-20 x 1 1/2		21024SP	100
1/4-20 x 2		21032SP	100

Button Head		Cardboard Box	
Size	Bit	Part #	Box Qty
6-32 x 1/4	1/8	22504SP	100
6-32 x 3/8		22506SP	100
6-32 x 1/2		22508SP	100
6-32 x 3/4		22512SP	100
6-32 x 1		22516SP	100
8-32 x 3/8	1/8	22606SP	100
8-32 x 1/2		22608SP	100
8-32 x 3/4		22612SP	100
8-32 x 1		22616SP	100
8-32 x 1 1/2		22624SP	100
10-24 x 1/4	5/32	22704SP	100
10-24 x 3/8		22706SP	100
10-24 x 1/2		22708SP	100
10-24 x 3/4		22712SP	100
10-24 x 1		22716SP	100
10-24 x 1 1/2		22724SP	100
10-32 x 1/4	5/32	22804SP	100
10-32 x 3/8		22806SP	100
10-32 x 1/2		22808SP	100
10-32 x 3/4		22812SP	100
10-32 x 1		22816SP	100
10-32 x 1 1/4		22820SP	100
10-32 x 1 1/2		22824SP	100
10-32 x 2		22832SP	100



FASTENERS • SCREWS

Larger sizes available upon request.
For bulk packaging, contact customer service for quantities and availability.

Harsh Environment Product

FLAT & BUTTON HEAD STAR PIN MACHINE SCREWS • STAINLESS STEEL

Flat Head		Cardboard Box	
Size	Bit	Part #	Box Qty
6-32 x 3/8	T-10H	20506XP	100
6-32 x 1/2		20508XP	100
6-32 x 3/4		20512XP	100
6-32 x 1		20516XP	100
8-32 x 3/8	T-15H	20606XP	100
8-32 x 1/2		20608XP	100
8-32 x 3/4		20612XP	100
8-32 x 1		20616XP	100
10-24 x 1/2	T-20H	20708XP	100
10-24 x 3/4		20712XP	100

Button Head		Cardboard Box	
Size	Bit	Part #	Box Qty
6-32 x 1/4	T-10H	22504XP	100
6-32 x 3/8		22506XP	100
6-32 x 1/2		22508XP	100
6-32 x 3/4		22512XP	100
6-32 x 1		22516XP	100
8-32 x 1/4	T-15H	22604XP	100
8-32 x 3/8		22606XP	100
8-32 x 1/2		22608XP	100
8-32 x 3/4		22612XP	100
8-32 x 1		22616XP	100



Harsh Environment Product

ROUND & FLAT HEAD BRASS MACHINE SCREWS • SLOTTED

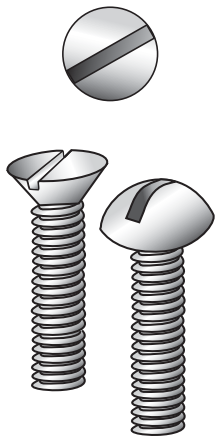

Round Head	Plastic Box		Best Merchandising Option	
	Size	Part #	Box Qty	Gravity Feed Jar
6-32 x 1/2	51208	100	▲	
6-32 x 3/4	51212	100	▲	
6-32 x 1	51216	100	▲	
8-32 x 3/4	51412	100	▲	
8-32 x 1	51416	100	▲	
8-32 x 1 1/4	51420	100	▲	
8-32 x 1 1/2	51424	100	▲	
8-32 x 2	51432	100	▲	
10-24 x 3/4	51512	100	▲	
10-24 x 1	51516	100	▲	
10-24 x 1 1/4	51520	100	▲	
10-24 x 1 1/2	51524	100	▲	
10-24 x 2	51532	50	▲	
10-32 x 3/8	51706	100	▲	
10-32 x 1/2	51708	100	▲	
10-32 x 3/4	51712	100	▲	
10-32 x 1	51716	100	▲	
10-32 x 1 1/4	51720	100	▲	
10-32 x 1 1/2	51724	50	▲	
1/4-20 x 3/8	51806	100	▲	
1/4-20 x 1/2	51808	100	▲	
1/4-20 x 3/4	51812	100	▲	
1/4-20 x 1	51816	50	▲	
1/4-20 x 1 1/4	51820	50	51820J	100/600
1/4-20 x 1 1/2	51824	50	51824J	100/600
1/4-20 x 2	51832	50	▲	

▲ Contact customer service for gravity feed jar availability.

♠ Harsh Environment Product

For bulk packaging, contact customer service for quantities and availability.

Flat Head	Plastic Box		Best Merchandising Option	
	Size	Part #	Box Qty	Gravity Feed Jar
6-32 x 1/2	56108	100	▲	
6-32 x 3/4	56112	100	▲	
6-32 x 1	56116	100	▲	
8-32 x 3/4	56312	100	▲	
8-32 x 1	56316	100	▲	
8-32 x 1 1/4	56320	100	▲	
8-32 x 1 1/2	56324	100	▲	

SCREW HOOKS • ZINC

						Best Merchandising Option			
						 Cardboard Box		 Gravity Feed Jar	
Size	Wire Diameter	Overall Length	Proj. Length	Wire Gauge	Hook Opening	Part #	Box Qty	Part #	Jar Qty/ Std Pk
0	3/8	4 5/16	3 1/16	0	1 1/32	65000 ★	50	▲	
2	2 1/64	4 7/16	3 3/16	2	1	65002 ★	50	▲	
4	1 7/64	3 7/8	2 5/8	4	2 7/32	65004 ★	50	▲	
6	1 5/64	3 3/8	2 1/8	6	2 5/32	65006 ★	100	▲	
8	3/16	2 9/16	1 11/16	8	1 7/32	65008 ★	100	▲	
10	1 1/64	2 1/16	1 3/8	10	1 3/32	65010 ★	100	▲	
12	1/8	1 1/16	1 11/16	12	9/32	65012 ★	100	▲	

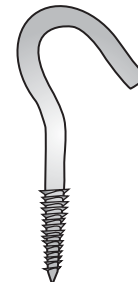

★ Made in USA

FASTENERS • SCREWS

SCREW EYES • ZINC

						Best Merchandising Option			
						 Cardboard Box		 Gravity Feed Jar	
Size	Wire Diameter	Overall Length	Shank Length	Wire Gauge	Inside Eye Dia.	Part #	Box Qty	Part #	Jar Qty/ Std Pk
0	5/16	3 3/16	1 9/16	0	1 3/16	66400 ★	50	▲	
2	1 7/64	2 11/16	1 13/32	2	2 3/32	66402 ★	50	▲	
4	1 7/64	2 3/16	1 1/8	4	3 9/64	66404 ★	50	▲	
6	1 5/64	1 15/16	3 1/32	6	1 7/32	66406 ★	50	▲	
8	3/16	1 5/8	1 3/16	8	1 5/32	66408 ★	100	▲	
10	1 1/64	1 3/8	1 1/16	10	1 3/32	66410 ★	100	▲	
12	1/8	1 3/16	3 5/64	12	3/8	66412 ★	100	▲	
14	3/32	1 1/16	1/2	14	1 1/32	66414 ★	100	▲	



★ Made in USA

▲ Contact customer service for gravity feed jar availability.

For bulk packaging, contact customer service for quantities and availability.

SCREW EYE LAGS • ZINC

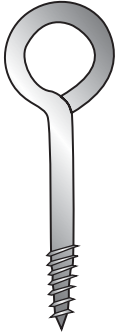

					Best Merchandising Option			
					Cardboard Box		Gravity Feed Jar	
Thread Diameter	Overall Length	Shank Length	Thread Length	Inside Eye Diameter	Part #	Box Qty	Part #	Jar Qty/Std Pk
1/4	3 3/4	2 3/4	1 5/16	1/2	66466 ★	100	66466J	100/600
1/4	5	4	1 7/8	1/2	66467 ★	100	▲	

★ Made in USA

ACOUSTICAL EYE LAGS & ACOUSTICAL EYE TEKS • ZINC

- Eye lags install easily with the acoustical eye teks.
- For use with tie wire, ceiling wire and jack chain applications.

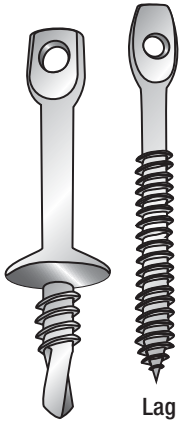

Teks

Lag

		Best Merchandising Option					
		Cardboard Box		Gravity Feed Jar		Job Jar	
Size	Application	Part #	Box Qty	Part #	Jar Qty/Std Pk	Part #	Jar Qty
1/4 x 3	Wood	59248	100	59248J	100/600	—	—
1/4 x 4	Wood	59264	100	▲		—	—
1/4 x 5	Wood	59280	100	▲		—	—
1/4 x 2	Metal*	59251	100	59251J	100/600	—	—

*Acoustical Eye Tek

Acoustical Eye Driver Installs Eye Lags & Eye Tekes



Size	Part #	Box Qty
Heavy Duty	59250	1

- ▲ Contact customer service for gravity feed jar availability.

For bulk packaging, contact customer service for quantities and availability.

GREEN GROUNDING SCREWS • ZINC

- Type C Point is also known as a pilot point or dog point.
- Type F Point is thread cutting.

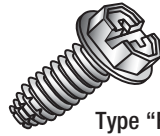

Type "F" Point



Type "C" Point



			Best Merchandising Option					
			100 Packs		Gravity Feed Jar		Job Jar	
Size	Head Style	Point Type	Part #	Box Qty/Std Pk	Part #	Jar Qty/Std Pk	Part #	Jar Qty
10-32 x 3/8	Hex Washer Head 5/16" Slot/Phil	Type F	80006	100/500	80006J	100/1200	80006-6	1000
10-32 x 3/8	Round Washer Head Phil	Type C	80017	100/500	80017J	100/1200	80017-6	1000
10-32 x 3/8	Hex Washer Head Quad Drive	Type C	80022	100/500	80022J	100/1200	—	

GROUNDING PIGTAILS WITH GROUNDING SCREWS • QUAD DRIVE • INSULATED

				Plastic Bag	
Gauge	Length	Point Size	Lead Style	Part #	Qty
#12	6 1/2"	Solid	Bare Wire Lead	80007	50
#14	6 1/2"	Solid	Bare Wire Lead	80016	50
#12	7 1/2"	Solid	Bare Wire Lead	80018	50
#12	8"	Stranded	Forked Terminal	80015	50
#12	9"	Solid	Bare Wire Lead	80021	50
#12	10"	Solid	Bare Wire Lead	80020	50



GREEN GROUNDING CLIPS • GREEN ZINC CHROMATE

- Connects non-metallic sheathed cable grounding conductor to outlet boxes.
- Press onto top edge of box to hold grounding conductor against side wall.
- Designed to fit all common sizes of copper or aluminum wire.







			Best Merchandising Option					
			Plastic Box		Gravity Feed Jar		Job Jar	
Gauge	Part #	Box Qty/Std Pk	Part #	Jar Qty/Std Pk	Part #	Jar Qty		
Universal #10-12-14	80011	100/500	80011J	100/1200	—			

For bulk packaging, contact customer service for quantities and availability.





CONDUIT HUBS • BRASS



		 Cardboard Box	
Description	Part #	Box Qty	
1/2" Conduit Hub	95050 	10	
3/4" Conduit Hub	95052 	10	
1" Conduit Hub	95054 	10	

GROUND ROD CLAMPS • FOR DIRECT BURIAL • BRASS





 Harsh Environment Product

		 Cardboard Box	
Description	Part #	Box Qty	
1/2" Ground Rod Clamp with Bronze or Stainless Screws	95070 	10	
5/8" Ground Rod Clamp with Bronze or Stainless Screws	95072 	10	
3/4" Ground Rod Clamp with Bronze or Stainless Screws	95074 	10	

GROUND CLAMPS

 Harsh Environment Product





- Fits #2, 4, 6, 8 and 10 AWG copper.

		 Cardboard Box		
Description	Metal	Application	Part #	Box Qty
1/2" – 1" Ground Clamp	Zinc	Copper and Aluminum Wire	95150	10
1/2" – 1" Ground Clamp (Brass-Plated)	Zinc	Bare Wire – Non UL	95151	10
1/2" – 1" Ground Clamp	Brass	Bare Wire	95152 	10
1 1/4" – 2" Ground Clamp	Brass	Bare Wire	95156 	10
2 1/2" – 4" Ground Clamp	Brass	Bare Wire	95158 	10
1/2" – 1" Ground Clamp	Bronze	Direct Burial	95154 	10

ARMORED GROUND CLAMPS • BRASS





 Harsh Environment Product

- Fits 4, 6 and 8 bare armored ground wire copper.

		 Cardboard Box	
Description	Metal	Part #	Box Qty
1/2" – 1" Armored Ground Clamp	Brass	95168 	10
1 1/4" – 2" Armored Ground Clamp	Brass	95170 	10

GROUND CLAMPS WITH THREADED HUBS • BRASS

 Harsh Environment Product

		 Cardboard Box	
Description	Application	Part #	Box Qty
1/2" – 1" Ground Clamp with 1/2" Hub	For Conduit Pipe	95190 	10
1/2" – 1" Ground Clamp with 3/4" Hub	For Conduit Pipe	95192 	10
1/2" – 1" Ground Clamp with 1" Hub	For Conduit Pipe	95194 	10

 Harsh Environment Product

HEX NUTS • ZINC PLATED

		Best Merchandising Option					
		Cardboard Box		Gravity Feed Jar		Job Jar	
				HEAVY DUTY			
Size	Part #	Box Qty	Part #	Jar Qty/ Std Pk	Part #	Jar Qty/ Std Pk	Part # Jar Qty
4-40	40103	100	▲		▲		—
6-32	40105	100	40105J	100/1200	▲		—
8-32	40110	100	40110J	100/1200	▲		—
10-24	40115	100	40115J	100/1200	▲		—
10-32	40120	100	40120J	100/1200	▲		—
12-24	40122	100	▲		▲		—
¼-20	40125	100	40125J	100/1200	▲		40125-6 750
¼-28	40126	100	▲		▲		—
⅝-18	40130	100	40130J	100/1200	▲		—
⅜-16	40135	100	40135J	100/600	40135HJ	100/600	40135-6 250
7/16-14	40137	100	▲		▲		—
½-13	40140	100	40140J	100/600	40140HJ	100/600	40140-6 150
⅝-11	40145	50	40145J	50/300	▲		—
¾-10	40150	50	40150J	50/300	40150HJ	50/300	—
1-8	40155	10	▲		▲		—



FASTENERS • NUTS/WASHERS

Kits					
Part #	Description				
39516 (405 Piece Kit)	Hex Nut Zinc Plated Kit				
	6-32 (100 Pieces)	8-32 (100 Pieces)	10-32 (100 Pieces)		
	¼-20 (50 Pieces)	⅝-18 (35 Pieces)	⅜-16 (20 Pieces)		

▲ Contact customer service for gravity feed jar availability.

For bulk packaging, contact customer service for quantities and availability.

HEX NUTS • BRASS

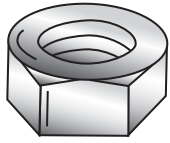

Size	Cardboard Box		Best Merchandising Option		Job Jar	
	Part #	Box Qty	Part #	Jar Qty/ Std Pk	Part #	Jar Qty
6-32	43105	100	▲			—
8-32	43110	100	▲			—
10-24	43115	100	▲			—
10-32	43120	100	▲			—
12-24	43122	100	▲			—
1/4-20	43125	100	43125J	100/1200		—
5/16-18	43130	100	▲			—
3/8-16	43135	100	▲			—
1/2-13	43140	100	▲			—

HEX NUTS • SILICON BRONZE



Size	Cardboard Box		Best Merchandising Option		Job Jar	
	Part #	Box Qty	Part #	Jar Qty/ Std Pk	Part #	Jar Qty
8-32	41110	100	▲			—
10-24	41115	100	▲			—
10-32	41120	100	▲			—
12-24	41122	100	▲			—
1/4-20	41125	100	41125J	100/1200		—
5/16-18	41130	100	41130J	100/1200		—
3/8-16	41135	100	41135J	100/600		—
1/2-13	41140	100	41140J	100/600		—
5/8-11	41145	100	▲			—

▲ Contact customer service for gravity feed jar availability.

Harsh Environment Product

For bulk packaging, contact customer service for quantities and availability.

HEX NUTS • STAINLESS STEEL

		Best Merchandising Option					
		Cardboard Box		Gravity Feed Jar		Job Jar	
Size	Part #	Box Qty	Part #	Jar Qty/ Std Pk	Part #	Jar Qty	
6-32	70105 ▾	100	70105J ▾	100/1200		—	
8-32	70110 ▾	100		▲		—	
10-24	70115 ▾	100		▲		—	
10-32	70120 ▾	100	70120J ▾	100/1200		—	
12-24	70122 ▾	100		▲		—	
¼-20	70125 ▾	100	70125J ▾	100/1200		—	
⅝-18	70130 ▾	100		▲		—	
⅜-16	70135 ▾	100	70135J ▾	100/600		—	
⅞-14	70137 ▾	100		▲		—	
½-13	70140 ▾	100	70140J ▾	100/600		—	
⅝-11	70145 ▾	100		▲		—	

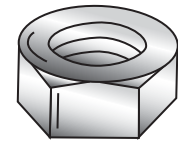

FASTENERS • NUTS/WASHERS

FLANGE WHIZ NUTS • ZINC

Harsh Environment Product

		Best Merchandising Option					
		Cardboard Box		Gravity Feed Jar		Job Jar	
Size	Part #	Box Qty	Part #	Jar Qty/ Std Pk	Part #	Jar Qty	
¼-20	40480	100	40480J	100/1200		—	
⅝-18	40481	100	40481J	100/1200		—	
⅜-16	40482	100	40482J	100/600		—	
½-13	40483	100	40483J	100/600		—	



GRADE 5 HEX NUTS

		Best Merchandising Option							
		Cardboard Box			Gravity Feed Jar			Job Jar	
Size	Part #	USA Part #	Box Qty	Part #	USA Part #	Jar Qty/ Std Pk	Part #	Jar Qty	
¼-20	40225	40225US ★	100		▲			—	
⅝-18	40230	40230US ★	100		▲			—	
⅜-16	40235	40235US ★	100	40235J	40235USJ ★	100/600		—	
½-13	40240	40240US ★	50	40240J	40240USJ ★	100/600		—	
¾-10	40250	40250US ★	50		▲			—	



▲ Contact customer service for gravity feed jar availability.

★ Made in USA

For bulk packaging, contact customer service for quantities and availability.

NYLOCK HEX NUTS

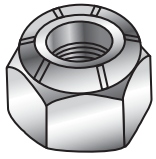

FASTENERS • NUTS/WASHERS

			Best Merchandising Option			
			Cardboard Box	Gravity Feed Jar	Job Jar	
Size	Part #	Box Qty	Part #	Jar Qty/ Std Pk	Part #	Jar Qty
4-40	40402	100	▲			—
6-32	40405	100	▲			—
8-32	40411	100	▲			—
10-32	40416	100	▲			—
10-24	40420	100	▲			—
¼-20	40425	100	40425J	100/600		—
⅝-18	40430	100	▲			—
⅜-16	40435	100	40435J	100/600		—
½-13	40440	100	▲			—

NYLOCK HEX NUTS • STAINLESS STEEL

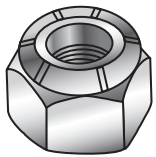

			Best Merchandising Option			
			Cardboard Box	Gravity Feed Jar	Job Jar	
Size	Part #	Box Qty	Part #	Jar Qty/ Std Pk	Part #	Jar Qty
6-32	70405 ♡	100	▲			—
8-32	70410 ♡	100	▲			—
10-24	70415 ♡	100	▲			—
10-32	70420 ♡	100	▲			—
¼-20	70425 ♡	100	▲			—
⅝-18	70430 ♡	100	▲			—
⅜-16	70435 ♡	100	▲			—
½-13	70440 ♡	100	▲			—
⅝-11	70445 ♡	100	▲			—

▲ Contact customer service for gravity feed jar availability.

♡ Harsh Environment Product

For bulk packaging, contact customer service for quantities and availability.

SPECIALTY NUTS • CAP NUTS • NICKEL PLATED

		Best Merchandising Option				
		Cardboard Box	Gravity Feed Jar	Job Jar		
Size	Part #	Box Qty	Part #	Jar Qty/ Std Pk	Part #	Jar Qty
8-32	41310	100	▲		—	
10-24	41315	100	▲		—	
10-32	41320	100	▲		—	
¼-20	41325	100	▲		—	
⅝-18	41331	100	▲		—	
⅜-16	41336	100	▲		—	
½-13	41341	100	▲		—	

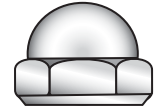

SPECIALTY NUTS • WING NUTS

		Best Merchandising Option				
		Cardboard Box	Gravity Feed Jar	Job Jar		
Size	Part #	Box Qty	Part #	Jar Qty/ Std Pk	Part #	Jar Qty
10-24	41415	100	▲		—	
10-32	41420	100	▲		—	
¼-20	41425	100	▲		—	
⅝-18	41430	100	▲		—	
⅜-16	41435	100	▲		—	



▲ Contact customer service for gravity feed jar availability.

For bulk packaging, contact customer service for quantities and availability.

TOOTHED LOCK WASHERS • INTERNAL • ZINC PLATED

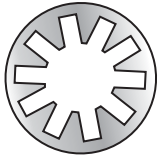

Size	Cardboard Box		Best Merchandising Option		Job Jar	
	Part #	Box Qty	Part #	Jar Qty/Std Pk	Part #	Jar Qty
#6	40605	100	▲			—
#8	40610	100	▲			—
#10 (3/16)	40615	100	▲			—
1/4	40620	100	▲			—
5/16	40625	100	▲			—

TOOTHED LOCK WASHERS • EXTERNAL • ZINC PLATED

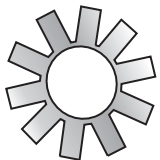

Size	Cardboard Box		Best Merchandising Option		Job Jar	
	Part #	Box Qty	Part #	Jar Qty/Std Pk	Part #	Jar Qty
#6	40606	100	40606J	100/1200		—
#8	40611	100	▲			—
#10 (9/16)	40616	100	▲			—
1/4	40621	100	40621J	100/1200		—
5/16	40626	100	▲			—

SPECIALTY WASHERS • SEALING WASHERS • GALVANIZED

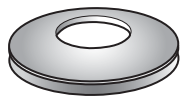

Size	Cardboard Box		Best Merchandising Option		Job Jar	
	Part #	Box Qty	Part #	Jar Qty/Std Pk	Part #	Jar Qty
#10	40410	100	▲			—
#12	40412	100	▲			—
1/4	40414	100	▲			—

Galvanized with Rubber Washer.

SPECIALTY WASHERS • OCTAGONAL • ZINC



Size	Cardboard Box		Best Merchandising Option		Job Jar	
	Part #	Box Qty	Part #	Jar Qty/Std Pk	Part #	Jar Qty
1/4 x 1 3/8	40760	100	40760J	100/600		—
3/8 x 1 3/8	40762	100	40762J	100/600		—

▲ Contact customer service for gravity feed jar availability.

For bulk packaging, contact customer service for quantities and availability.

SPECIALTY WASHERS • BELLEVILLE • SPRING STEEL

		Best Merchandising Option				
		Cardboard Box	Gravity Feed Jar	Job Jar		
Size	Spring Force	Part #	Box Qty	Part #	Jar Qty/ Std Pk	Part # Jar Qty
¼	569#	40905	100	▲		—
⅝	1682#	40910	100	▲		—
¾	1700#	40915	100	▲		—
½	2337#	40925	100	▲		—



SPECIALTY WASHERS • BELLEVILLE • STAINLESS STEEL

		Best Merchandising Option				
		Cardboard Box	Gravity Feed Jar	Job Jar		
Size	Spring Force	Part #	Box Qty	Part #	Jar Qty/ Std Pk	Part # Jar Qty
½	2337#	40925SS	100	40925SSJ	100/600	—



FINISH CUP WASHERS • BRASS

		Best Merchandising Option				
		Cardboard Box	Gravity Feed Jar	Job Jar		
Size		Part #	Box Qty	Part #	Jar Qty/ Std Pk	Part # Jar Qty
#6		43805	100	▲		—
#8		43810	100	▲		—
#10		43815	100	▲		—

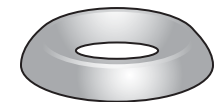

FINISH CUP WASHERS • STAINLESS STEEL

		Best Merchandising Option				
		Cardboard Box	Gravity Feed Jar	Job Jar		
Size		Part #	Box Qty	Part #	Jar Qty/ Std Pk	Part # Jar Qty
#6		71105	100	▲		—
#8		71110	100	▲		—
#10		71115	100	▲		—
#12		71120	100	▲		—
¼		71125	100	▲		—
⅜		71135	100	▲		—



▲ Contact customer service for gravity feed jar availability.
 Harsh Environment Product

For bulk packaging, contact customer service for quantities and availability.

FLAT CUT WASHERS • ZINC PLATED

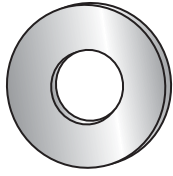

Best Merchandising Option		
SAE	Gravity Feed Jar	
Size	Part #	Jar Qty/Std Pk
#6	40305SAEJ	100/1200
#8	40310SAEJ	100/1200
5/16"	40330SAEJ	100/1200
1/2"	40340SAEJ	100/600
1/4"	40326SAEJ	100/1200
3/8"	40336SAEJ	100/1200

Kits			
Part #	Description		
Flat Cut Washer Kit			
39518	#8 (100 Pieces)	1/4"	(100 Pieces)
(370 Pc Kit)	#10 (100 Pieces)	5/16"	(35 Pieces)
		3/8"	(35 Pieces)

FASTENERS • NUTS/WASHERS

Additional Merchandising Options						
Size	Cardboard Box		Gravity Feed Jar		Job Jar	
	Part #	Box Qty	Part #	Jar Qty/Std Pk	Part #	Jar Qty
#6	40305	100	40305J	100/1200	—	—
#8	40310	100	40310J	100/1200	—	—
#10	40315	100	40315J	100/1200	—	—
#12	40317	100	40317J	100/1200	—	—
1/4"	40325	100	40325J	100/1200	40325-6	1000
5/16"	40330	100	40330J	100/1200	—	—
3/8"	40335	100	40335J	100/600	40335-6	250
1/2"	40340	100	40340J	100/600	40340-6	150
5/8"	40345	100	40345J	100/600	—	—
3/4"	40350	100	40350J	100/600	—	—

FLAT CUT WASHERS • STAINLESS STEEL

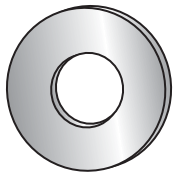

Best Merchandising Option						
Size	Cardboard Box		Gravity Feed Jar		Job Jar	
	Part #	Box Qty	Part #	Jar Qty/Std Pk	Part #	Jar Qty
#6	70305 ♡	100	70305J ♡	100/1200	—	—
#8	70310 ♡	100	70310J ♡	100/1200	—	—
#10	70315 ♡	100	70315J ♡	100/1200	—	—
1/4"	70325 ♡	100	70325J ♡	100/1200	—	—
5/16"	70330 ♡	100	▲	—	—	—
3/8"	70335 ♡	100	70335J ♡	100/1200	—	—
7/16"	70337 ♡	100	▲	—	—	—
1/2"	70340 ♡	100	▲	—	—	—
5/8"	70345 ♡	100	▲	—	—	—

For bulk packaging, contact customer service for quantities and availability.

▲ Contact customer service for gravity feed jar availability.

♡ Harsh Environment Product

FLAT CUT WASHERS • SILICON BRONZE

		Best Merchandising Option				
		Cardboard Box	Gravity Feed Jar	Job Jar		
Size	Part #	Box Qty	Part #	Jar Qty/ Std Pk	Part #	Jar Qty
#8	42310	100	▲			—
#10	42315	100	▲			—
1/4"	42325	100	▲			—
5/16"	42330	100	▲			—
3/8"	42335	100	▲			—
1/2"	42340	100	42340J	100/600		—
5/8"	42345	100	▲			—
3/4"	42350	100	▲			—

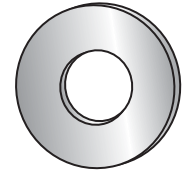

FLAT CUT WASHERS • BRASS

		Best Merchandising Option				
		Cardboard Box	Gravity Feed Jar	Job Jar		
Size	Part #	Box Qty	Part #	Jar Qty/ Std Pk	Part #	Jar Qty
#6	43305	100	▲			—
#8	43310	100	▲			—
#10	43315	100	▲			—
#12	43320	100	▲			—
1/4"	43325	100	▲			—
5/16"	43330	100	▲			—
3/8"	43335	100	▲			—
1/2"	43340	100	▲			—
5/8"	43345	100	▲			—
3/4"	43350	100	▲			—

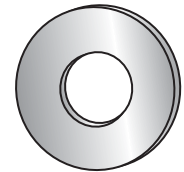

▲ Contact customer service for gravity feed jar availability.

Harsh Environment Product

For bulk packaging, contact customer service for quantities and availability.

FENDER WASHERS • ZINC PLATED

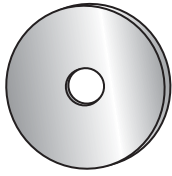

FASTENERS • NUTS/WASHERS

Size	Cardboard Box		Best Merchandising Option		Job Jar	
	Part #	Box Qty	Part #	Jar Qty/Std Pk	Part #	Jar Qty
1/8 x 1"	40705	100	40705J	100/1200	—	—
3/16 x 1"	40709	100	40709J	100/1200	—	—
3/16 x 1 1/8"	40710	100	40710J	100/1200	—	—
3/16 x 1 1/4"	40715	100	40715J	100/1200	—	—
1/4 x 1"	40720	100	40720J	100/1200	40720-6	350
1/4 x 1 1/4"	40725	100	40725J	100/600	40725-6	250
1/4 x 1 1/2"	40730	100	40730J	100/600	40730-6	250
1/4 x 2"	40733	100	40733J	100/600	—	—
5/16 x 1 1/4"	40735	100	40735J	100/600	—	—
5/16 x 1 1/2"	40740	100	40740J	100/600	—	—
3/8 x 1"	40741	100	40741J	100/1200	—	—
3/8 x 1 1/4"	40743	100	40743J	100/600	40743-6	250
3/8 x 1 1/2"	40745	100	40745J	100/600	40745-6	250
1/2 x 1 1/2"	40750	100	40750J	100/600	—	—
1/2 x 2"	40755	100	40755J	100/600	—	—

Kits			
Part #	Description		
39519 (120 Pc Kit)	Fender Washer Kit	3/16 x 1 1/4" (40 Pcs)	1/4 x 1 1/4" (40 Pcs)
			3/8 x 1 1/4" (40 Pcs)

FENDER WASHERS • STAINLESS STEEL



Size	Cardboard Box		Best Merchandising Option		Job Jar	
	Part #	Box Qty	Part #	Jar Qty/Std Pk	Part #	Jar Qty
3/16 x 1"	70709	100	▲	—	—	—
3/16 x 1 1/4"	70710	100	▲	—	—	—
1/4 x 1"	70720	100	70720J	100/1200	—	—
1/4 x 1 1/4"	70725	100	70725J	100/600	—	—
1/4 x 1 1/2"	70730	100	70730J	100/600	—	—
5/16 x 1 1/2"	70740	100	▲	—	—	—
3/8 x 1 1/4"	70743	100	▲	—	—	—
3/8 x 1 1/2"	70745	100	70745J	100/600	—	—

▲ Contact customer service for gravity feed jar availability.
 ▽ Harsh Environment Product

For bulk packaging, contact customer service for quantities and availability.

SPLIT LOCK WASHERS • SILICON BRONZE

		Best Merchandising Option				
		Cardboard Box	Gravity Feed Jar	Job Jar		
Size	Part #	Box Qty	Part #	Jar Qty/ Std Pk	Part #	Jar Qty
#6	42505	100	▲		—	
#8	42510	100	▲		—	
#10	42515	100	42515J	100/1200	—	
#12	42517	100	▲		—	
1/4"	42525	100	42525J	100/1200	—	
5/16"	42530	100	▲		—	
3/8"	42535	100	▲		—	
1/2"	42540	100	42540J	100/600	—	
5/8"	42545	100	▲		—	
3/4"	42550	100	▲		—	



SPLIT LOCK WASHERS • STAINLESS STEEL

		Best Merchandising Option				
		Cardboard Box	Gravity Feed Jar	Job Jar		
Size	Part #	Box Qty	Part #	Jar Qty/ Std Pk	Part #	Jar Qty
#6	70505	100	70505J	100/600	—	
#8	70510	100	▲		—	
#10	70515	100	70515J	100/600	—	
1/4"	70525	100	70525J	100/600	—	
5/16"	70530	100	70530J	100/600	—	
3/8"	70535	100	70535J	100/600	—	
7/16"	70537	100	▲		—	
1/2"	70540	100	70540J	100/600	—	
5/8"	70545	100	▲		—	



▲ Contact customer service for gravity feed jar availability.
 Harsh Environment Product

For bulk packaging, contact customer service for quantities and availability.

SPLIT LOCK WASHERS • ZINC PLATED

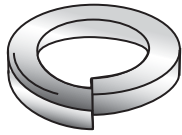

FASTENERS • NUTS/WASHERS

Size	Cardboard Box		Gravity Feed Jar		Job Jar	
	Part #	Box Qty	Part #	Jar Qty/ Std Pk	Part #	Jar Qty
#6	40505	100	40505J	100/1200	—	—
#8	40510	100	40510J	100/1200	—	—
#10	40515	100	40515J	100/1200	—	—
#12	40517	100	40517J	100/1200	—	—
1/4"	40525	100	40525J	100/1200	—	—
5/16"	40530	100	40530J	100/1200	—	—
3/8"	40535	100	40535J	100/1200	—	—
1/2"	40540	100	40540J	100/600	—	—
5/8"	40545	100	40545J	100/600	—	—

Kits			
Part #	Description		
39517 (425 Piece Kit)	Split Lock Washer Kit		
	#8 (100 Pieces)	1/4" (100 Pieces)	5/16" (60 Pieces)
	#10 (100 Pieces)	3/8" (40 Pieces)	1/2" (25 Pieces)

For bulk packaging, contact customer service for quantities and availability.

HEX LAG SCREWS STAINLESS STEEL • ZINC PLATED

		Best Merchandising Option			
		Cardboard Box	Gravity Feed Jar	Job Jar	
Size	Part #	Box Qty	Part #	Jar Qty/ Std Pk	Part # Jar Qty
¼ x 1	57016	100	57016J	100/600	—
¼ x 1¼	57020	100	57020J	100/600	—
¼ x 1½	57024	100	57024J	100/600	—
¼ x 2	57032	100	57032J	100/600	—
¼ x 2½	57040	100	57040J	100/600	—
¼ x 3	57048	100	57048J	100/600	—
¼ x 3½	57056	100	57056J	50/300	—
¼ x 4	57064	100	57064J	100/600	—
⅕ x 1	57216	100	▲	—	—
⅕ x 1¼	57220	100	▲	—	—
⅕ x 1½	57224	100	57224J	100/600	—
⅕ x 2	57232	100	57232J	100/600	—
⅕ x 2½	57240	100	57240J	100/600	—
⅕ x 3	57248	100	57248J	50/300	—
⅕ x 3½	57256	50	▲	—	—
⅕ x 4	57264	50	57264J	50/300	—
⅜ x 1	57416	100	57416J	100/600	—
⅜ x 1¼	57420	100	57420J	100/600	—
⅜ x 1½	57424	100	57424J	100/600	—
⅜ x 2	57432	50	57432J	100/600	—
⅜ x 2½	57440	50	57440J	50/300	—
⅜ x 3	57448	50	57448J	50/300	—
⅜ x 3½	57456	50	57456J	50/300	—
⅜ x 4	57464	50	57464J	50/300	—
⅜ x 4½	57472	50	▲	—	—
⅜ x 5	57480	50	57480J	50/300	—
⅜ x 5½	57488	50	▲	—	—
⅜ x 6	57496	50	▲	—	—
½ x 1½	57824	50	57824J	50/300	—
½ x 2	57832	50	▲	—	—
½ x 2½	57840	50	▲	—	—
½ x 3	57848	50	57848J	100/600	—
½ x 3½	57856	25	▲	—	—
½ x 4	57864	25	57864J	25/150	—
½ x 4½	57872	25	▲	—	—
½ x 5	57880	25	▲	—	—
½ x 5½	57888	25	▲	—	—
½ x 6	57896	25	▲	—	—

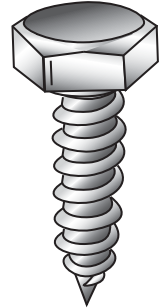
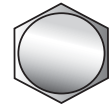

▲ Contact customer service for gravity feed jar availability.

For bulk packaging, contact customer service for quantities and availability.

FASTENERS • BOLTS

CARRIAGE BOLTS • ZINC PLATED

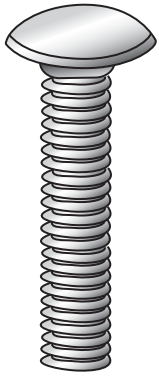

FASTENERS • BOLTS

Size	Cardboard Box		Best Merchandising Option		Job Jar	
	Part #	Box Qty	Part #	Jar Qty/ Std Pk	Part #	Jar Qty
1/4-20 x 3/4	55112	100	▲		—	
1/4-20 x 1	55116	100	▲		—	
1/4-20 x 1 1/4	55120	100	▲		—	
1/4-20 x 1 1/2	55124	100	▲		—	
1/4-20 x 2	55132	100	▲		—	
1/4-20 x 2 1/2	55140	100	▲		—	
1/4-20 x 3	55148	100	▲		—	
1/4-20 x 3 1/2	55156	100	▲		—	
1/4-20 x 4	55164	100	▲		—	
5/16-18 x 3/4	55312	100	▲		—	
5/16-18 x 1	55316	100	▲		—	
5/16-18 x 1 1/4	55320	100	▲		—	
5/16-18 x 1 1/2	55324	100	▲		—	
5/16-18 x 2	55332	100	▲		—	
5/16-18 x 2 1/2	55340	100	▲		—	
5/16-18 x 3	55348	100	▲		—	
5/16-18 x 3 1/2	55356	50	▲		—	
5/16-18 x 4	55364	50	▲		—	
3/8-16 x 3/4	55512	100	▲		—	
3/8-16 x 1	55516	100	▲		—	
3/8-16 x 1 1/4	55520	100	▲		—	
3/8-16 x 1 1/2	55524	100	▲		—	
3/8-16 x 2	55532	100	▲		—	
3/8-16 x 2 1/2	55540	50	55540J	50/300	—	
3/8-16 x 3	55548	50	▲		—	
3/8-16 x 3 1/2	55556	50	▲		—	
3/8-16 x 4	55564	50	▲		—	

▲ Contact customer service for gravity feed jar availability.

For bulk packaging, contact customer service for quantities and availability.

GRADE 2 FULLY THREADED MACHINE TAP BOLTS • ZINC

Size	Cardboard Box		Best Merchandising Option		Job Jar	
	Part #	Qty	Part #	Jar Qty/ Std Pk	Part #	Jar Qty
¼-20 x 1¼	55022	100	55022J	100/600	—	—
¼-20 x 1½	55026	100	55026J	100/600	—	—
¼-20 x 2	55034	100	▲		—	—
¼-20 x 2½	55035	100	▲		—	—
¼-20 x 3	55050	100	▲		—	—
⅝-18 x 1	55216	100	▲		—	—
⅝-18 x 1½	55227	100	▲		—	—
⅝-18 x 2	55234	100	▲		—	—
⅝-18 x 2½	55242	100	▲		—	—
⅜-16 x 1¼	55422	100	55422J	100/600	—	—
⅜-16 x 2	55434	50	▲		—	—
⅜-16 x 2½	55442	50	▲		—	—
⅜-16 x 3	55450	50	▲		—	—
½-13 x 1	55816	50	▲		—	—
½-13 x 1¼	55820	50	55820J	50/300	—	—
½-13 x 1½	55826	50	▲		—	—
½-13 x 2	55834	50	▲		—	—
½-13 x 2½	55842	50	▲		—	—
½-13 x 3	55850	50	▲		—	—

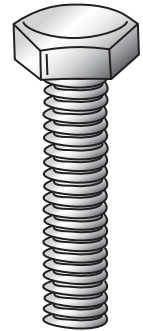

FASTENERS • BOLTS

▲ Contact customer service for gravity feed jar availability.

For bulk packaging, contact customer service for quantities and availability.

GRADE 2 HEX HEAD MACHINE BOLTS • ZINC



- 1", ¾" and ½" are fully threaded.
- No markings and made of low grade carbon steel.



Partially Threaded

▲ Contact customer service for gravity feed jar availability.

For bulk packaging, contact customer service for quantities and availability.

			Best Merchandising Option			
			Cardboard Box	Gravity Feed Jar	Job Jar	
Size	Part #	Qty	Part #	Jar Qty/ Std Pk	Part #	Jar Qty
¼-20 x ½	55008	100	55008J	100/1200	—	—
¼-20 x ¾	55012	100	55012J	100/600	—	—
¼-20 x 1	55016	100	55016J	100/600	—	—
¼-20 x 1¼	55020	100	55020J	100/600	—	—
¼-20 x 1½	55024	100	55024J	100/600	—	—
¼-20 x 2	55032	100	55032J	100/600	—	—
¼-20 x 2½	55040	100	55040J	100/600	—	—
¼-20 x 3	55048	100	55048J	100/600	—	—
¼-20 x 3½	55056	50	▲	—	—	—
¼-20 x 4	55064	50	▲	—	—	—
5/16-18 x ½	55208	100	▲	—	—	—
5/16-18 x ¾	55212	100	55212J	100/600	—	—
5/16-18 x 1	55216	100	55216J	100/600	—	—
5/16-18 x 1¼	55220	100	55220J	100/600	—	—
5/16-18 x 1½	55224	100	55224J	100/600	—	—
5/16-18 x 2	55232	100	▲	—	—	—
5/16-18 x 2½	55240	100	55240J	100/600	—	—
5/16-18 x 3	55248	100	55248J	100/600	—	—
5/16-18 x 3½	55256	50	▲	—	—	—
5/16-18 x 4	55264	50	▲	—	—	—
3/8-16 x ½	55408	100	55408J	100/600	—	—
3/8-16 x ¾	55412	100	55412J	100/600	—	—
3/8-16 x 1	55416	100	55416J	100/600	—	—
3/8-16 x 1¼	55420	100	55420J	100/600	—	—
3/8-16 x 1½	55424	100	55424J	100/600	—	—
3/8-16 x 2	55432	50	55432J	100/600	—	—
3/8-16 x 2½	55440	50	55440J	50/300	—	—
3/8-16 x 3	55448	50	55448J	50/300	—	—
3/8-16 x 3½	55456	50	55456J	50/300	—	—
3/8-16 x 4	55464	50	55464J	50/300	—	—
½-13 x ¾	55812	50	55812J	50/300	—	—
½-13 x 1	55816	50	55816J	50/300	—	—
½-13 x 1¼	55820	50	55820J	50/300	—	—
½-13 x 1½	55824	50	55824J	50/300	—	—
½-13 x 2	55832	50	55832J	50/300	—	—
½-13 x 2½	55840	50	55840J	50/300	—	—
½-13 x 3	55848	50	55848J	50/300	—	—
½-13 x 3½	55856	25	55856J	25/150	—	—
½-13 x 4	55864	25	55864J	25/150	—	—

GRADE 5 HEX HEAD BOLTS • ZINC

- Has three hash marks and made of medium carbon steel—quenched and tempered.
- See Grade 5 Hex Head Nuts on page 57.
- Fully threaded.

Size	Cardboard Box			Best Merchandising Option		
	Part #	USA Part #	Qty	Part #	USA Part #	Jar Qty/Std Pk
¼-20 x ½	55009	55009US ★	100	55009J	55009USJ ★	100/600
¼-20 x ¾	55013	55013US ★	100	55013J	55013USJ ★	100/600
¼-20 x 1	55017	55017US ★	100	55017J	55017USJ ★	100/600
¼-20 x 1¼	55021	55021US ★	100	55021J	55021USJ ★	100/600
¼-20 x 1½	55025	55025US ★	100	55025J	55025USJ ★	100/600
¼-20 x 2	55033	55033US ★	100	55033J	55033USJ ★	100/600
¼-20 x 2½	55041	55041US ★	100	55041J	55041USJ ★	100/600
¼-20 x 3	55049	55049US ★	100	55049J	55049USJ ★	100/600
⅝-18 x ½	55209	55209US ★	100	55209J	55209USJ ★	100/600
⅝-18 x ¾	55213	55213US ★	100	55213J	55213USJ ★	100/600
⅝-18 x 1	55217	55217US ★	100	55217J	55217USJ ★	100/600
⅝-18 x 1¼	55221	55221US ★	100	55221J	55221USJ ★	100/600
⅝-18 x 1½	55225	55225US ★	100	55225J	55225USJ ★	100/600
⅝-18 x 2	55233	55233US ★	100	55233J	55233USJ ★	100/600
⅝-18 x 2½	55241	55241US ★	100	55241J	55241USJ ★	100/600
¾-16 x ½	55409	55409US ★	100	55409J	55409USJ ★	100/600
¾-16 x ¾	55413	55413US ★	100	55413J	55413USJ ★	100/600
¾-16 x 1	55417	55417US ★	100	55417J	55417USJ ★	100/600
¾-16 x 1¼	55421	55421US ★	100	55421J	55421USJ ★	100/600
¾-16 x 1½	55425	55425US ★	100	55425J	55425USJ ★	100/600
¾-16 x 2	55433	55433US ★	50	55433J	55433USJ ★	100/600
¾-16 x 2½	55441	55441US ★	50	55441J	55441USJ ★	50/300
¾-16 x 3	55449	55449US ★	50	55449J	55449USJ ★	50/300
½-13 x ¾	55813	55813US ★	50	55813J	55813USJ ★	100/600
½-13 x 1	55817	55817US ★	50	55817J	55817USJ ★	50/300
½-13 x 1¼	55821	55821US ★	50	55821J	55821USJ ★	50/300
½-13 x 1½	55825	55825US ★	50	55825J	55825USJ ★	50/300
½-13 x 2	55833	55833US ★	50	55833J	55833USJ ★	50/300
½-13 x 2½	55841	55841US ★	50	55841J	55841USJ ★	50/300
½-13 x 3	55849	55849US ★	50	55849J	▲	50/300



FASTENERS • BOLTS

- ▲ Contact customer service for gravity feed jar availability.
- ★ Made in USA

For bulk packaging, contact customer service for quantities and availability.

HEX HEAD BOLTS • 18-8 STAINLESS STEEL



See page 65
for Stainless
Steel Split
Lock Washers.

Size	Cardboard Box		Best Merchandising Option	
	Part #	Box Qty	Gravity Feed Jar	Jar Qty/ Std Pk
1/4-20 x 3/4*	74212 ♡	100	74212J ♡	100/600
1/4-20 x 1*	74216 ♡	100	74216J ♡	100/600
1/4-20 x 1 1/4	74220 ♡	100	74220J ♡	100/600
1/4-20 x 1 1/2	74224 ♡	100	▲	
1/4-20 x 2	74232 ♡	100	▲	
1/4-20 x 2 1/2	74240 ♡	100	▲	
1/4-20 x 3	74248 ♡	100	▲	
5/16-18 x 3/4*	74312 ♡	100	▲	
5/16-18 x 1*	74316 ♡	100	▲	
5/16-18 x 1 1/4	74320 ♡	100	▲	
5/16-18 x 1 1/2	74324 ♡	100	▲	
5/16-18 x 2	74332 ♡	100	▲	
5/16-18 x 2 1/2	74340 ♡	100	▲	
5/16-18 x 3	74348 ♡	100	▲	
3/8-16 x 3/4*	74412 ♡	100	▲	
3/8-16 x 1*	74416 ♡	100	74416J ♡	100/600
3/8-16 x 1 1/4*	74420 ♡	100	74420J ♡	100/600
3/8-16 x 1 1/2	74424 ♡	100	74424J ♡	100/600
3/8-16 x 2	74432 ♡	50	▲	
3/8-16 x 2 1/2	74440 ♡	50	▲	
3/8-16 x 3	74448 ♡	50	▲	
1/2-13 x 3/4*	74612 ♡	50	▲	
1/2-13 x 1*	74616 ♡	50	▲	
1/2-13 x 1 1/4*	74620 ♡	50	▲	
1/2-13 x 1 1/2*	74624 ♡	50	▲	
1/2-13 x 2	74632 ♡	50	▲	
1/2-13 x 2 1/2	74640 ♡	50	▲	
1/2-13 x 3	74648 ♡	50	▲	

▲ Contact customer service for gravity feed jar availability.

*These sizes are fully threaded.

♡ Harsh Environment Product

For bulk packaging, contact customer service
for quantities and availability.

HEX HEAD BOLTS • SILICON BRONZE

Size	Cardboard Box		Best Merchandising Option	
	Part #	Box Qty	Gravity Feed Jar	Jar Qty/Std Pk
1/4-20 x 1/2*	54108	100	▲	
1/4-20 x 5/8*	54110	100	▲	
1/4-20 x 3/4*	54112	100	▲	
1/4-20 x 1*	54116	100	▲	
1/4-20 x 1 1/4	54120	100	▲	
1/4-20 x 1 1/2	54124	100	▲	
1/4-20 x 2	54132	100	▲	
5/16-18 x 1/2*	54208	100	▲	
5/16-18 x 3/4*	54212	100	▲	
5/16-18 x 1*	54216	100	54216J	100/600
5/16-18 x 1 1/4	54220	100	▲	
5/16-18 x 1 1/2	54224	100	▲	
5/16-18 x 2	54232	100	▲	
3/8-16 x 1/2*	54408	100	▲	
3/8-16 x 3/4*	54412	100	▲	
3/8-16 x 1*	54416	100	▲	
3/8-16 x 1 1/4*	54420	100	▲	
3/8-16 x 1 1/2	54424	100	54424J	100/600
3/8-16 x 2	54432	50	▲	
3/8-16 x 2 1/2	54440	50	▲	
3/8-16 x 3	54448	50	▲	
3/8-16 x 3 1/2	54456	50	▲	
3/8-16 x 4	54464	50	▲	
1/2-13 x 3/4*	54812	50	▲	
1/2-13 x 1*	54816	50	▲	
1/2-13 x 1 1/4*	54820	50	▲	
1/2-13 x 1 1/2*	54824	50	54824J	100/600
1/2-13 x 1 3/4	54828	50	▲	
1/2-13 x 2	54832	50	54832J	50/300
1/2-13 x 2 1/2	54840	50	54840J	50/300
1/2-13 x 3	54848	50	54848J	50/300
1/2-13 x 3 1/2	54856	25	▲	
1/2-13 x 4	54864	25	▲	



See page 65 for Silicon Bronze Split Lock Washers.

FASTENERS • SCREWS

▲ Contact customer service for gravity feed jar availability.
 *These sizes are fully threaded.
 ◀ Harsh Environment Product

For bulk packaging, contact customer service for quantities and availability.

STOVE BOLTS • ROUND HEAD MACHINE SCREW WITH HEX NUTS • ZINC

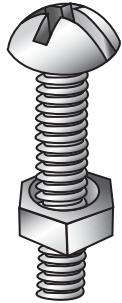

Size	Cardboard Box		Best Merchandising Option		Job Jar	
	Part #	Qty	Part #	Jar Qty/Std Pk	Part #	Jar Qty
¼-20 x ½	25508	100	25508J	100/600	—	—
¼-20 x ¾	25512	100	25512J	100/600	—	—
¼-20 x 1	25516	100	25516J	100/600	—	—
¼-20 x 1¼	25520	100	25520J	100/600	—	—
¼-20 x 1½	25524	100	25524J	100/600	—	—
¼-20 x 2	25532	100	25532J	100/600	—	—
¼-20 x 2½	25540	100	▲	—	—	—
¼-20 x 3	25548	100	▲	—	—	—
⅜-16 x 1	25716	100	25716J	100/600	—	—
⅜-16 x 1¼	25720	100	▲	—	—	—
⅜-16 x 1½	25724	100	▲	—	—	—
⅜-16 x 2	25732	100	▲	—	—	—

▲ Contact customer service for gravity feed jar availability.

Kits	
Part #	Description
39539 (440 Piece Kit)	10-24 (⅜) Stove Bolt Kit
	10-24 x ½" (60 Pieces) 10-24 x 1" (40 Pieces) 10-24 x 1½" (20 Pieces)
	10-24 x ¾" (50 Pieces) 10-24 x 1¼" (30 Pieces) 10-24 x 2" (20 Pieces) 10-24 Hex Nut (220 Pieces)
39540 (220 Piece Kit)	¼-20 Stove Bolt Kit
	¼-20 x ½" (30 Pieces) ¼-20 x 1" (20 Pieces) ¼-20 x 1½" (10 Pieces)
	¼-20 x ¾" (25 Pieces) ¼-20 x 1¼" (15 Pieces) ¼-20 x 2" (10 Pieces) ¼-20 Hex Nut (110 Pieces)

EYE BOLTS WITH HEX NUTS • ZINC

						Cardboard Box		Best Merchandising Option	
						Cardboard Box		Gravity Feed Jar	
Size	Overall Length	Thread Size	Thread Length	Shank Length	Inside Eye Diameter	Part #	Box Qty	Part #	Jar Qty/Std Pk
3/16	1 1/2	10-24	25/32	7/8	3/8	64024	100	▲	
	2	10-24	1	1 3/8	3/8	64032	50	▲	
	2 1/4	10-24	1 5/8	1 3/4	3/8	64040	50	▲	
	3	10-24	2 1/8	2 1/4	3/8	64048	50	▲	
1/4	2	1/4-20	7/8	1	9/16	64132	30	64132J	100/600
	2 1/2	1/4-20	1 3/8	1 1/2	9/16	64140	30	64140J	100/600
	3	1/4-20	1 1/4	2	9/16	64148	30	64148J	100/600
	4	1/4-20	2 3/4	3	9/16	64164	30	64164J	50/300
	5	1/4-20	3	4	9/16	64180	30	64180J	50/300
5/16	3 1/4	5/16-18	1 3/4	2	3/4	64252	20	▲	
	4	5/16-18	2 1/4	2 1/2	3/4	64264	20	▲	
	5	5/16-18	3	3 1/2	3/4	64280	20	▲	
3/8	4	3/8-16	2	2 1/4	1	64364	20	64364J	50/300
	5	3/8-16	3	3 1/4	1	64380	20	64380J	25/150
	6	3/8-16	4	4 1/4	1	64396	20	64396J	25/150
	8	3/8-16	4	6 1/4	1	64399	20	▲	
1/2	6	1/2-13	3	3 3/4	1 1/4	64496	10	▲	
	8	1/2-13	3	5 3/4	1 1/4	64499	10	▲	
	10	1/2-13	3	7 3/4	1 1/4	64510	10	▲	
	12	1/2-13	3	9 3/4	1 1/4	64512	10	▲	

▲ Contact customer service for gravity feed jar availability.

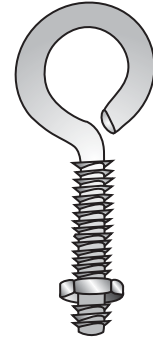

FASTENERS • BOLTS

U-BOLTS • ZINC • NUTS & PLATES INCLUDED

Fits Pipe Size	Height	Width Between Legs	Thread Length	Thread Size	Part #	Qty
2	5	2 3/8	3	5/16-18	67005	1
2	7	2 3/8	3	5/16-18	67007	1
2	9	2 3/8	3	5/16-18	67009	1



ACOUSTICAL WEDGE ANCHORS • OVERHEAD SUSPENSIONS



- Used to hang lighting fixtures and drop ceilings from concrete.
- Great for concrete and other solid materials.
- Sets when load is applied.

See Tie Wire on page 108.

		Best Merchandising Option					
		Cardboard Box		Gravity Feed Jar		Job Jar	
Size	Bit Size	Part #	Box Qty	Part #	Jar Qty/Std Pk	Part #	Jar Qty
¼ x 2¼	1⅝	62029	100	62029J	100/600	—	—

SLEEVE ANCHORS • MEDIUM DUTY • CINDERBLOCK & BRICK



- Can be used in brick, cinder block, thin wall, as well as solid concrete.
- Can be removed after installation (unlike wedge anchor).
- Use same drill size as bolt diameter.

Installation

1. Use a solid carbide tipped bit. Drill the hole perpendicular to the work surface. Drill the hole as deep as the full length of the anchor.

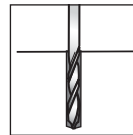

2. Clean the hole using compressed air and wire brush.



3. Insert anchor through the fixture and into the hole until nut and washer rest against the fixture, or tap into the hole and then place bracket over the anchor.

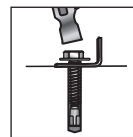

4. Tighten the nut with a torque wrench to the proper torque.



		Best Merchandising Option					
		Cardboard Box		Gravity Feed Jar		Job Jar	
Size	Drill Style	Part #	Box Qty	Part #	Jar Qty/Std Pk	Part #	Jar Qty
¼ x 1⅝	Acorn	61413	100	61413J	100/600	—	—
¼ x 2¼	Acorn	61422	100	▲		—	—
⅜ x 1⅝	Hex	61617	50	61617J	50/300	—	—
⅜ x 3	Hex	61630	50	61630J	50/300	—	—
⅜ x 4	Hex	61640	50	61640J	50/300	—	—
½ x 2¼	Hex	61822	25	61822J	25/150	—	—
½ x 3	Hex	61830	25	61830J	25/150	—	—
½ x 4	Hex	61840	25	▲		—	—

▲ Contact customer service for gravity feed jar availability.

STRIKE SET ANCHORS • SOLID CONCRETE

- ICBO# 5045
- Easier, faster installation.

Installation

1. Drill hole to minimum depth and diameter.
2. Clean the hole with pressurized air.
3. Set nut and washer for proper installment.
4. Drive center pin flush with top of anchor.

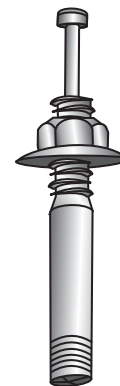

FASTENERS • ANCHORS

Size	Cardboard Box		10 Packs		Best Merchandising Option Job Jar	
	Part #	Box Qty	Part #	Box Qty	Part #	Jar Qty
1/4 x 1 3/4	63028	100	63029	10		▲
1/4 x 2 3/8	63038	100	63039	10		▲
5/16 x 2	63132	100	—			▲
5/16 x 2 3/4	63144	100	—			▲
3/8 x 2 3/8	63238	100	63239	10		▲
3/8 x 3 1/2	63256	100	63257	10		▲
3/8 x 4 3/4	63276	100	—			▲
1/2 x 2 3/4	63444	50	—			▲
1/2 x 3 1/2	63456	50	—			▲
1/2 x 4 3/4	63476	50	—			▲
1/2 x 6	63496	50	—			▲
5/8 x 4	63664	30	—			▲
5/8 x 6	63696	25	—			▲
3/4 x 7 1/2	63898	10	—			▲

▲ Contact customer service for gravity feed jar availability.



DOUBLE DRYWALL ANCHOR



- Works when penetrating wood stud behind drywall.
- No pre-drilling required.
- Quick and easy installation using a #2 Phillips.
- Up to 75lb load capacity when using 5/8" drywall.
- Easily removable.
- Not recommended for overhead use.



Best Merchandising Option

	 Kits	 Gravity Feed Jar	 Job Jar
Description	Part #	Part #	Part #
Double Drywall Anchor (50 Pieces) Phillips			
#8 x 1¼ PHSMS (50 Pieces) #2 Phillips Driver Bit (1 Piece)	39940 (101 Piece Kit)	39940J (101 Piece Kit)	39940-6 (201 Piece Kit)

ZAMAC "HAMMER DRIVE" NAIL-IN ANCHORS





- Economical choice for solid concrete, solid brick or block.
- Best suited for light-duty applications.
- Not recommended for vibrating loads or overhead installations.
- Requires no layout or hold spotting.
- 1,300 lb ultimate pullout (reference value).
Use ¼ as safe working load (325#).

Installation

1. Drill hole ¼" deeper than required, blow hole clean of debris.
2. Insert anchor through fixture and hammer pin.

Best Merchandising Option

		 Cardboard Box	 Gravity Feed Jar	 Job Jar			
Size	Drill Size	Part #	Box Qty	Part #	Jar Qty/ Std Pk	Part #	Jar Qty
3/16 x 7/8	3/16	59011	100	59011J	100/600	—	—
1/4 x 3/4	1/4	59012	100	59012J	100/600	—	—
1/4 x 1	1/4	59016	100	59016J	100/600	59016-6	200
1/4 x 1¼	1/4	59020	100	59020J	100/600	59020-6	150
1/4 x 1½	1/4	59024	100	59024J	100/600	—	—
1/4 x 2	1/4	59032	100	59032J	100/600	—	—

NYLON NAIL-IN ANCHORS • LIGHT DUTY • REMOVABLE

- Removable version of Zamac Nail-In anchors.
- Often selected for bathroom applications (white finish).
- Light-duty applications only.
- 285 lb ultimate pull out (reference value).
Use ¼ as safe work load (71#).

Installation

1. Drill hole ¼" deeper than required, blow hole clean of debris.
2. Insert anchor through fixture and hammer pin.

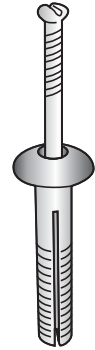

		Best Merchandising Option					
		Cardboard Box	Gravity Feed Jar	Job Jar			
Size	Drill Size	Part #	Box Qty	Part #	Jar Qty/ Std Pk	Part #	Jar Qty
¼ x 1	¼	61218	100	61218J	100/600	—	—
¼ x 1½	¼	61226	100	61226J	100/600	—	—
¼ x 2	¼	61232	100	▲		—	—

- ▲ Contact customer service for gravity feed jar availability.
- ★ Made in USA

For bulk packaging, contact customer service for quantities and availability.

FLAT HEAD SPLIT BOLT ANCHORS • ZINC PLATED STEEL

- One piece “pre-expanded” anchor compresses as it is driven into base material.
- Very high shear values.
- Great for heavy-duty permanent installations.

		Best Merchandising Option					
		Cardboard Box	Gravity Feed Jar	Job Jar			
Size	Drill Size	Part #	Box Qty	Part #	Jar Qty/ Std Pk	Part #	Jar Qty
¼ x 1½	¼	59124	100	▲		—	—
¼ x 2	¼	59132	100	▲		—	—
¼ x 2½	¼	59140	100	▲		—	—
¼ x 3	¼	59148	100	▲		—	—
¼ x 3½	¼	59156	100	▲		—	—
¼ x 4	¼	59164	100	▲		—	—

- ▲ Contact customer service for gravity feed jar availability.



WEDGE ANCHORS • HEAVY DUTY • CONCRETE & STONE • STAINLESS STEEL

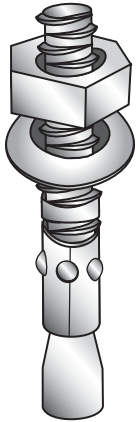

Installation

1) Select a carbide drill bit with a diameter equal to the anchor diameter. Drill hole to any depth exceeding the desired embedment.

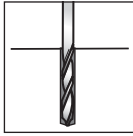

2) Clean hole or continue drilling additional depth to accommodate drill fines.



3) Assemble washer and nut, leaving nut flush with end of anchor to protect threads. Drive anchor through material to be fastened until washer is flush to surface of material.

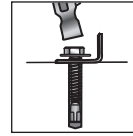

4) Expand anchor by tightening nut 3–5 turns past the hand tight position.

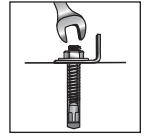

FASTENERS • ANCHORS

- Extremely high pull out value.
- Resistant to vibrating loads.

Size	Cardboard Box		Best Merchandising Option		Job Jar	
	Part #	Box Qty	Part #	Jar Qty/Std Pk	Part #	Jar Qty
1/4 x 1 3/4	76528	100	▲			—
1/4 x 2 1/4	76536	100	▲			—
1/4 x 3 1/4	76552	100	▲			—
3/8 x 2 1/4	76736	50	▲			—
3/8 x 3	76748	50	76748J	50/300		—
3/8 x 3 3/4	76760	50	76760J	50/300		—
3/8 x 5	76780	50	▲			—
1/2 x 2 3/4	76944	25	▲			—
1/2 x 3 3/4	76960	25	▲			—
1/2 x 4 1/4	76968	25	▲			—
1/2 x 5 1/2	76988	25	▲			—
1/2 x 7	76998	25	▲			—
5/8 x 3 1/2	77156	10	▲			—
5/8 x 4 1/4	77166	10	▲			—
5/8 x 6	77196	10	▲			—

▲ Contact customer service for gravity feed jar availability.

♣ Harsh Environment Product

Approvals/Listings

Wedge Anchors:

ICC Evaluation Service, Inc. # ESR-2251

- Category 1 performance rating
- 2006 IBC compliant
- Meets ACI 318 ductility requirements
- Tested in accordance with ACI 355.2 and ICC-ES AC193
- For use in seismic zones A & B
- 1/4", 3/8", and 1/2" diameter anchors listed in ESR-2251

Underwriters Laboratories

Factory Mutual

City of Los Angeles - #RR2748

California State Fire Marshall

Caltrans

Meets or exceeds U.S. Government G.S.A. Specification A-A-1923A Type 4 (formerly GSA: FF-S-325 Group II, Type 4, Class 1)

WEDGE ANCHORS • HEAVY DUTY • CONCRETE & STONE • ZINC

		Best Merchandising Option					
		Cardboard Box		Gravity Feed Jar		Job Jar	
Size	Min Embed	Part #	Box Qty	Part #	Jar Qty/ Std Pk	Part #	Jar Qty
1/4 x 1 1/4	1 1/8	62028	100	62028J ★	100/600	—	—
1/4 x 2 1/4	1 1/8	62036	100	62036J ★	100/600	—	—
1/4 x 3 1/4	1 1/8	62052	100	62052J ★	100/600	—	—
3/8 x 2 1/4	1 1/2	62236	50	62236J ★	50/300	—	—
3/8 x 2 3/4	1 1/2	62244	50	62244J ★	50/300	—	—
3/8 x 3	1 1/2	62248	50	62248J ★	50/300	—	—
3/8 x 3 3/4	1 1/2	62260	50	62260J ★	50/300	—	—
3/8 x 5	1 1/2	62280	50	62280J ★	50/300	—	—
3/8 x 7	1 1/2	62298	50	▲	—	—	—
1/2 x 2 3/4	2 1/4	62444	25	62444J ★	25/150	—	—
1/2 x 3 3/4	2 1/4	62460	25	62460J ★	25/150	—	—
1/2 x 4 1/4	2 1/4	62468	25	62468J ★	25/150	—	—
1/2 x 5 1/2	2 1/4	62488	25	▲	—	—	—
1/2 x 7	2 1/4	62498	25	—	—	—	—
5/8 x 3 1/2	2 3/4	62656	10	▲	—	—	—
5/8 x 4 1/4	2 3/4	62672	25	▲	—	—	—
5/8 x 5	2 3/4	62680	10	▲	—	—	—
5/8 x 6	2 3/4	62696	10	▲	—	—	—
5/8 x 8 1/2	2 3/4	62700	10	—	—	—	—
3/4 x 4 3/4	3 1/4	62876	10	▲	—	—	—
3/4 x 5 1/2	3 1/4	62888	10	▲	—	—	—
3/4 x 6 1/4	3 1/4	62897	10	—	—	—	—
3/4 x 7	3 1/4	62898	10	—	—	—	—
3/4 x 8 1/2	3 1/4	62900	10	—	—	—	—
3/4 x 10	3 1/4	62910	10	—	—	—	—

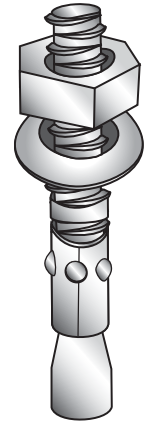

- See page 80 for installation instructions.
- Extremely high pull out value.
- Resistant to vibrating loads.

FASTENERS • ANCHORS

Wedge Anchors are also called:

- Red Heads
- Parabolts
- Kwikbolts
- Thunder Studs
- Stud Bolts

▲ Contact customer service for gravity feed jar availability.

		10 Packs	
Size	Min Embed	Part #	Box Qty
1/4 x 2 1/4	1/8	62037 ★	10
1/4 x 3 1/4	1/8	62053 ★	10
3/8 x 2 1/4	1 1/2	62237 ★	10
3/8 x 2 3/4	1 1/2	62245 ★	10
3/8 x 3	1 1/2	62249 ★	10

★ Made in USA

LAG SCREW SHIELDS • MORTAR JOINT APPLICATIONS

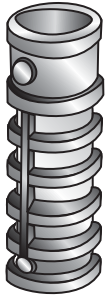

- Screw style anchor designed for lag bolts.
- Best used on mortar joints of block or brick walls.
- Short style preferred for harder masonry.

Installation

1. Drill hole at least 1/2" deeper than minimum embedment.
2. Insert anchor into hole until it is flush with the surface.
3. Position fixture and insert lag bolt.
4. Tighten with wrench.

			Best Merchandising Option					
			Cardboard Box		Gravity Feed Jar		Job Jar	
Lag Screw Diameter	Length	Drill Diameter	Part #	Box Qty	Part #	Jar Qty/Std Pk	Part #	Jar Qty
1/4 S	1	1/2	60602	50	60602J	50/300	—	—
5/16 S	1 1/4	1/2	60606	50	60606J	50/300	—	—
3/8 S	1 3/4	5/8	60610	50	60610J	50/300	—	—
1/2 S	2	3/4	60614	25	▲		—	—
5/8 S	2	7/8	60618	25	▲		—	—
1/4 L	1 1/2	1/2	60604	50	▲		—	—
5/16 L	1 3/4	1/2	60608	50	▲		—	—
3/8 L	2 1/2	5/8	60612	50	60612J	50/300	—	—
1/2 L	3	3/4	60616	25	▲		—	—

▲ Contact customer service for gravity feed jar availability.

LEAD SCREW ANCHORS • ACCEPTS SHEET METAL OR WOOD SCREWS



- Designed for use with sheet metal screws or wood screws in concrete, block or brick.
- 100% lead alloy composition molds itself to form tight bond.
- Recommended for light-duty applications.
- See instructions above

				Cardboard Box	
Lag Screw Diameter	Length	Drill Diameter	Min Depth	Part #	Box Qty
#6-8	3/4	1/4	3/4	60802	100
#6-8	1	1/4	1	60804	100
#6-8	1 1/2	1/4	1 1/2	60806	100
#10-12-14	3/4	5/16	3/4	60808	100
#10-12-14	1	5/16	1	60810	100
#10-12-14	1 1/2	5/16	1 1/2	60812	100
#16-18	1	3/8	1	60814	100
#16-18	1 1/2	3/8	1 1/2	60816	100

STEEL DROP-IN ANCHORS

					Best Merchandising Option			
					Cardboard Box	Gravity Feed Jar		
Thread Size	Length	Thread Depth	Drill/Hole Diameter	Min Embed	Part #	Box Qty	Part #	Jar Qty/ Std Pk
1/4-20	1	7/8	3/8	1	60402	100	60402J	100/600
3/8-16	1 1/16	5/8	1/2	1 5/8	60404	100	60404J	100/600
1/2-13	2	1 3/16	5/8	2	60406	50	60406J	50/300
5/8-11	2 1/2	1 3/16	7/8	2 1/2	60408	25	▲	
3/4-10	3 1/8	1 3/16	1	3 3/16	60410	25	▲	
3/8-16	Shallow Embedment Anchors		1/2	3/4	60405	100	▲	

▲ Contact customer service for gravity feed jar availability.

Setting Tool		
Size	Part #	Qty
1/4	60440	1
3/8	60444	1
1/2	60446	1
5/8	60448	1
3/4	60450	1

Installation

1. Use a masonry bit. Drill the hole to any depth slightly deeper than the anchor length.
2. Clean the hole using pressurized air.
3. Insert the anchor into the hole and hammer the anchor down until it is flush with the surface.
4. Expand the anchor by hitting the setting tool until the shoulder is flush with the anchor.



Setting Tool Included

- Use with machine screw, bolt or threaded rod.
- For use in solid concrete, hard stone and solid block.
- Internally threaded expansion anchor.
- **Requires layout or hole spotting.**

LEAD MACHINE SCREW ANCHORS

			Best Merchandising Option				
			Cardboard Box	Gravity Feed Jar		Job Jar	
Thread Size	Drill/Hole Diameter	Min Embed	Part #	Box Qty	Part #	Jar Qty/ Std Pk	Part # Jar Qty
10-24	3/8	5/8	60206	100	60206J	100/600	—
1/4-20	1/2	7/8	60212	100	60212J	100/600	—
5/16-18	5/8	1	60214	100	60214J	100/600	—
3/8-16	3/4	1 1/4	60216	50	60216J	50/300	—
1/2-13	7/8	1 1/2	60218	50	60218J	50/300	—

Setting Tool		
Size	Part #	Qty
10-24	60236	1
1/4	60240	1
5/16	60242	1
3/8	60244	1
1/2	60248	1

Installation

1. Drill a hole equal to the nominal diameter of the anchor and deeper than the intended embedment.
2. Clean the hole using compressed air.
3. Insert anchor into the hole and drive expander shield over cone using a setting tool.
4. Position fixture, insert fastener and tighten.



Setting Tool Included

- Great for installation in older concrete where crumbling is a concern.
- Lead alloy molds itself to concrete surface for a tight fit.
- Zamac 7 internally threaded core.
- **Requires layout or hole spotting.**

TOGGLER® SNAPTOGGLE® TOGGLE BOLT ANCHORS • HIGH STRENGTH

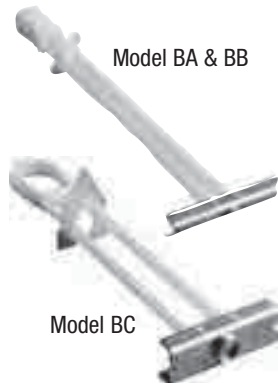

Toggles Only			Cardboard Box	
Model	Screw Size	Drill Size	Part #	Box Qty
BA	10-24 (3/16)	1/2"	58732 ★	100
BB	1/4-20 (1/4)	1/2"	58816 ★	100
BC	3/8-16	3/4"	58900 ★	25

★ Made in USA

Mini Kits		Clam Shell	
Screw Size	Drill Size	Part #	Box Qty
10-24 x 2 Th Sq/Slot	1/2"	58742 ★	6
10-24 x 3 Th Sq/Slot	1/2"	58743 ★	6
10-24 x 4 Th Sq/Slot	1/2"	58744 ★	6
1/4-20 x 3 Th Sq/Slot	1/2"	58817 ★	6
1/4-20 x 4 Th Sq/Slot	1/2"	58818 ★	6

Installation for Models BA & BB



1. Drill 1/2" (Ø13mm) hole. Hold metal channel flat alongside plastic straps and slide channel through hole. Minimum clearance behind wall: 1 7/8" (48mm).

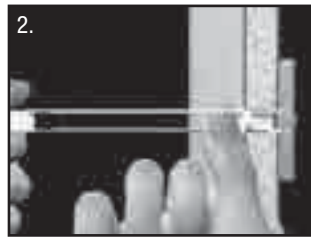

2. Hold ends of straps between thumb and forefinger and pull toward you until channel rests flush behind wall. Slide plastic cap along straps with other hand until flange of cap is flush with wall.



3. Snap straps at wall by pushing side to side, snapping off straps level with flange of cap.

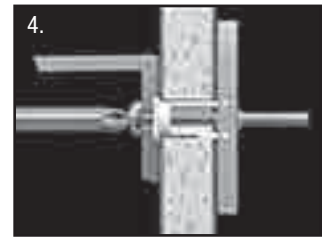

4. Place item over flange. Insert bolt through item and tighten until flush against item, then stop.

Use machine screw or bolt to match thread in channel: BA (3/16"-24), BB (1/4"-20).

Bolt length = item thickness + wall or ceiling thickness + 1/2" (13mm)

U.S. Patent No. 6,161,999 and foreign counterparts thereof and of 4,650,386. Other patents pending. TOGGLER and SNAPTOGGLE are worldwide registered trademarks of Mechanical Plastics Corp.

Ultimate Tensile Pull-Out Values (lb)

Anchor	UNC Thread	Drill Dia.	1/2" Drywall	5/8" Drywall	*1/2" and 25 Gauge Stud	*5/8" and 25 Gauge Stud	Concrete Block	1/2" Steel Plate	Stainless in 1/2" Steel ³
BA	3/16"-24	1/2"	238	356	412	462	802	918 ¹	1193 ¹
BB	1/4"-20	1/2"	265	356	425	464	1080	1288 ²	1735 ¹
BE	5/16"-18	3/4"	270	480	439	477	1400	1680	2118
BC	3/8"-16	3/4"	275	576	466	488	1745	1692	2523 ¹
BD	1/2"-13	3/4"	275	576	468	513	**2038 ²	2605	3150

* Failure measured as breakage of drywall portion

** Failure of block

¹ Stainless steel bolts used

² Hardened bolts used

³ Stainless steel channel tested with stainless bolts in 1/2" steel plate

Ultimate Shear (lb)

Anchor	UNC Thread	Drill Dia.	1/2" Drywall	5/8" Drywall
BA	3/16"-24	1/2"	247	298
BB	1/4"-20	1/2"	241	324
BC	3/8"-16	3/4"	292	406

TRUSS HEAD TOGGLE BOLTS & WINGS • SLOTTED/SQUARE • ZINC • WINGS INCL.

		Best Merchandising Option					
		Cardboard Box	Gravity Feed Jar	Job Jar			
Screw Size	Drill/Hole Diameter	Part #	Box Qty	Part #	Jar Qty/Std Pk	Part #	Jar Qty
1/8 x 2	3/8	58132	100	58132J	100/600	—	—
1/8 x 3	3/8	58148	100	58148J	100/600	—	—
1/8 x 4	3/8	58164	100	▲		—	—
3/16 x 2	1/2	58332	100	▲		—	—
3/16 x 3	1/2	58348	50	58348J	50/300	—	—
3/16 x 4	1/2	58364	50	58364J	50/300	—	—
1/4 x 3	5/8	58548	50	58548J	50/300	—	—
1/4 x 4	5/8	58564	50	58564J	50/300	—	—

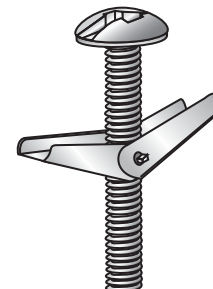

▲ Contact customer service for gravity feed jar availability.

TRUSS HEAD TOGGLE BOLTS & WINGS • PHILLIPS/SLOTTED • ZINC • WINGS INCL.

		Best Merchandising Option					
		Cardboard Box	Gravity Feed Jar	Job Jar			
Screw Size	Drill/Hole Diameter	Part #	Box Qty	Part #	Jar Qty/Std Pk	Part #	Jar Qty
1/8 x 2	3/8	58133	100	58133J	100/600	—	—
1/8 x 3	3/8	58149	100	58149J	100/600	—	—
1/8 x 4	3/8	58165	100	58165J	50/300	—	—
3/16 x 2	1/2	58333	100	58333J	100/600	—	—
3/16 x 3	1/2	58349	50	58349J	50/300	—	—
3/16 x 4	1/2	58365	50	58365J	50/300	—	—
1/4 x 3	5/8	58549	50	58549J	50/300	—	—
1/4 x 4	5/8	58565	50	58565J	50/300	—	—

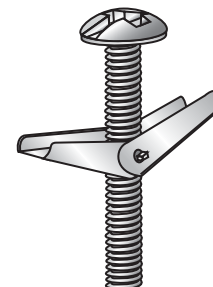

ROUND HEAD TOGGLE BOLTS & WINGS • SLOTTED • ZINC • WINGS INCLUDED

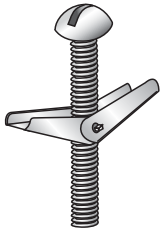

		Cardboard Box		Best Merchandising Option		Job Jar	
Screw Size	Drill/Hole Diameter	Part #	Box Qty	Part #	Jar Qty/Std Pk	Part #	Jar Qty
3/16 x 6	1/2	58396	50	58396J	50/300	—	—
1/4 x 6	5/8	58496	50	58496J	50/300	—	—
5/16 x 3	7/8	58647	50	▲		—	—
3/8 x 3	1	58648	50	58648J	25/150	—	—
3/8 x 4	1	58664	25	58664J	25/150	—	—
3/8 x 5	1	58680	25	▲		—	—
3/8 x 6	1	58696	25	58696J	20/120	—	—

FASTENERS • ANCHORS

TOGGLE BOLT WINGS • SPRING LOADED • ZINC



		Cardboard Box		Best Merchandising Option		Job Jar	
Size	Part #	Box Qty	Part #	Jar Qty/Std Pk	Part #	Jar Qty	
1/8	58031	100	58031J	100/600	—	—	
3/16	58231	100	▲		—	—	
1/4-20	58431	100	58431J	100/600	—	—	
5/16-18	58531	100	▲		—	—	
3/8-16	58631	50	58631J	100/600	—	—	

▲ Contact customer service for gravity feed jar availability.

For bulk packaging, contact customer service for quantities and availability.

TAPCON™ FLAT HEAD CONCRETE SCREWS • PHILLIPS

		100 Packs		Best Merchandising Option	
				Gravity Feed Jar	
Size	Drill	Part #	Box Qty	Part #	Jar Qty/Std Pk
3/16 x 1 1/4	5/32 x 3 1/2	60520 ★	100	▲	
3/16 x 1 3/4	5/32 x 3 1/2	60528 ★	100	▲	
3/16 x 2 1/4	5/32 x 4 1/2	60536 ★	100	▲	
3/16 x 2 3/4	5/32 x 4 1/2	60544 ★	100	▲	
3/16 x 3 1/4	5/32 x 5 1/2	60552 ★	100	▲	
3/16 x 3 3/4	5/32 x 5 1/2	60560 ★	100	▲	
3/16 x 4	5/32 x 5 1/2	60564 ★	100	▲	
1/4 x 1 1/4	3/16 x 3 1/2	60720 ★	100	▲	
1/4 x 1 3/4	3/16 x 3 1/2	60728 ★	100	▲	
1/4 x 2 1/4	3/16 x 4 1/2	60736 ★	100	60736J	100/600
1/4 x 2 3/4	3/16 x 4 1/2	60744 ★	100	▲	
1/4 x 3 1/4	3/16 x 4 1/2	60752 ★	100	▲	
1/4 x 4	3/16 x 5 1/2	60764 ★	100	▲	

FREE DRILL BIT IN EVERY PACK

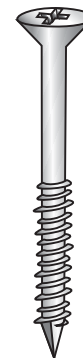

FASTENERS • ANCHORS

- ▲ Contact customer service for gravity feed jar availability.
- ★ Made in USA

For bulk packaging, contact customer service for quantities and availability.

TAPCON™ CARBIDE-TIPPED MASONRY DRILL BITS

Installation

1. Drill a hole 1/2" deeper than the screw embedment.
2. Clean hole of all debris.
3. Insert the screw through the fixture and into the hole.
4. Drive the screw slowly, allowing the threads to tap into the base material.

Size	Part #	Box Qty/Std Pk
5/32 x 3 1/2	61105	1/10
5/32 x 4 1/2	61107	1/10
5/32 x 5 1/2	61108	1/10
3/16 x 3 1/2	61109	1/10
3/16 x 4 1/2	61111	1/10
3/16 x 5 1/2	61113	1/10



TAPCON™ CONDRIVE INSTALLATION TOOL

- **ALL-IN-ONE** – The condrive sleeve with hex head and phillips socket snaps over the masonry drill bit for quick installations in concrete, block or brick.

		Kits		
Part #	Description			
61102 ★ (Tool Kit)	Condrive 1000 Installation Tool			
	1 Drill Driver	1 Phillips Bit Holder	2 Hex Driver	
	1 Drill Adaptor	2 Phillips Bits	1 Allen Hex Key	
61103 ★ (Tool Kit)	Condrive 500 Installation Tool			
	1 Drill Driver	2 Phillips Bits		
	1 Drill Adaptor	1 Allen Hex Key		



★ Made in USA

TAPCON™ CONCRETE SCREWS • HEX WASHER HEAD • SLOTTED

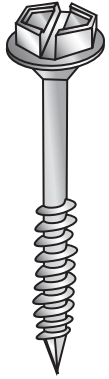

- Fast, easy installation in concrete, brick or block.
- Superior pullout and shear strengths.
- High-low thread design.
- ClimaSeal™ finish provides extended corrosion resistance.

- Tapcon™ is recommended for areas with soft concrete aggregate.

- ICC# 3320
- GSA 523
- MetroDade #90-1223
- NIS-64269

FASTENERS • ANCHORS

▲ Contact customer service for gravity feed jar availability.

For bulk packaging, contact customer service for quantities and availability.

		Cardboard Box		Best Merchandising Option	
		Gravity Feed Jar		Gravity Feed Jar	
Size	Drill	Part #	Box Qty/Std Pk	Part #	Jar Qty/Std Pk
3/16 x 1 1/4	5/32 x 3 1/2	60120 ★	100	60120J ★	100/600
3/16 x 1 3/4	5/32 x 3 1/2	60128 ★	100	60128J ★	100/600
3/16 x 2 1/4	5/32 x 4 1/2	60136 ★	100	60136J ★	100/600
3/16 x 2 3/4	5/32 x 4 1/2	60144 ★	100	60144J ★	100/600
3/16 x 3 1/4	5/32 x 5 1/2	60152 ★	100	60152J ★	100/600
3/16 x 3 3/4	5/32 x 5 1/2	60160 ★	100	▲	
3/16 x 4	5/32 x 5 1/2	60164 ★	100	▲	
1/4 x 1 1/4	3/16 x 3 1/2	60320 ★	100	60320J ★	100/600
1/4 x 1 3/4	3/16 x 3 1/2	60328 ★	100	60328J ★	100/600
1/4 x 2 1/4	3/16 x 4 1/2	60336 ★	100	60336J ★	100/600
1/4 x 2 3/4	3/16 x 4 1/2	60344 ★	100	60344J ★	100/600
1/4 x 3 1/4	3/16 x 4 1/2	60352 ★	100	60352J ★	100/600
1/4 x 3 3/4	3/16 x 5 1/2	60360 ★	100	▲	
1/4 x 4	3/16 x 5 1/2	60364 ★	100	60364J ★	100/600

FREE DRILL BIT IN EVERY PACK

★ Made in USA

Condrite Installation Tool:

- Prevents overtightening.
- Eliminates need to remove and replace driver bits.
- See page 87.
- For additional Masonry/SDS Bits see pages 146-147.
- Fast changing simplifiers



Part #	Description		
62003 ★ (112 Piece Kit)	3/16" Diameter Tapcon™ Kit		
	1 1/4" (50 Piece)	1 3/4" (35 Piece)	2 1/4" (25 Piece)
	3 1/2" Bit (1)	4 1/2" Bit (1)	
62006 ★ (112 Piece Kit)	1/4" Diameter Tapcon™ Kit		
	1 1/4" (50 Piece)	1 3/4" (35 Piece)	2 1/4" (25 Piece)
	3 1/2" Bit (1)	4 1/2" Bit (1)	

★ Made in USA

EZ TOGGLE™ ANCORS • ITW BUILDEX

- One-piece hollow wall anchor offers superior pullout and shear values.
- No pre-drilling required.

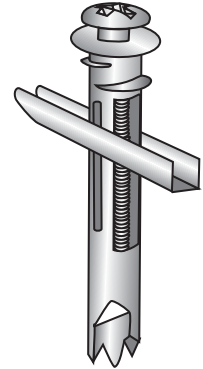

Description	Cardboard Box		Best Merchandising Option		Job Jar	
	Part #	Box Qty	Part #	Jar Qty/Std Pk	Part #	Jar Qty
EZ Toggle™ w/2" Phillips	59520	50	59520J	50/300	—	—
EZ Toggle™ w/2" Square/Phillips	59521	50	▲		—	—

Description	Kits	Best Merchandising Option	
		Part #	Part #
EZ Toggle™ w/2" Phillips			
EZ Toggles™ (25 Pieces)	39926	39926J	
2" Screws (25 Pieces)	(50 Piece Kit)	(50 Piece Kit)	
EZ Toggle™ w/2" Square/Phillips			
EZ Toggles™ (25 Pieces)	39927	39927J	
2" Square/Phillips (25 Pieces)	(50 Piece Kit)	(50 Piece Kit)	

▲ Contact customer service for gravity feed jar availability.

HOLLOW WALL ANCHORS • COMBO PHILLIPS/SLOTTED SCREW • ZINC

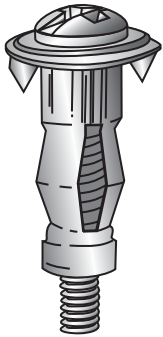

FASTENERS • ANCHORS

					Best Merchandising Option			
					Cardboard Box	Gravity Feed Jar		
Thread Size	Hex Length	Sleeve Length	Drill Size	Wall Thickness	Part #	Box Qty	Part #	Jar Qty/Std Pk
1/8	Extra Short	1 1/16	1/4	1/16-1/4	60002	100	▲	
1/8	Short	1 3/4	1/4	1/8-1/2	60004	100	60004J	100/600
1/8	Long	2 1/4	1/4	5/8-7/8	60006	100	▲	
1/8	Extra Long	2 11/16	1/4	1 1/4-1 1/2	60008	100	▲	
3/16	Short	2	3/8	1/8-5/8	60011	50	▲	
3/16	Long	2 1/2	3/8	5/8-13/16	60012	50	▲	
3/16	Extra Long	3	3/8	1 1/4-1 3/4	60014	50	▲	
1/4	Short	2 1/4	1/2	1/8-1/2	60016	50	60016J	100/600
1/4	Long	2 3/4	1/2	5/8-7/8	60018	50	60018J	100/600
1/4	Extra Long	3 3/8	1/2	1 1/4-1 3/4	60020	50	60020J	50/300
Hex Head	Hex Length	Sleeve Length	Drill Size	Wall Thickness	Part #	Box Qty	Part #	Jar Qty/Std Pk
1/8	Short	1 3/4	1/4	5/8-7/8	60022	100	▲	
1/8	Long	2 1/4	1/4	1/8-13/16	60024	100	▲	

HOLLOW WALL ANCHORS • PHILLIPS/SLOTTED SCREWS WITH DRIVE POINT



- Easy to install, requires no drilling.
- Screw can be removed as often as needed.

Installation

1. Drive anchor with hammer until cap prongs are embedded in the wall.
2. Turn screw clockwise to tighten.

					Best Merchandising Option			
					Cardboard Box	Gravity Feed Jar		
Thread Size	Length	Sleeve Length	Drill Size	Wall Thickness	Part #	Box Qty	Part #	Jar Qty/Std Pk
1/8	SD	1 3/8	1/4	1/8-1/2	60026	100	60026J	100/600
1/8	LD	2	1/4	5/8-7/8	60028	100	▲	
1/8	SLD	2 3/8	1/4	1/8-13/16	60030	100	▲	

▲ Contact customer service for gravity feed jar availability.

TOGGLER® PLASTIC TOGGLE ANCHORS

				Best Merchandising Option			
				Cardboard Box		Gravity Feed Jar	
Wall Thickness	Drill Size	Screw Diameter	Type	Part #	Box Qty	Part #	Jar Qty/ Std Pk
1/8-1/4	5/16	#8	A	68006 ★	100	▲	
3/8-1/2	5/16	#8	B	68008 ★	100	▲	
5/8-3/4	5/16	#8	C	68010 ★	100	▲	
3/8-1/2	5/16	#8	Hook	68012 ★	100	▲	

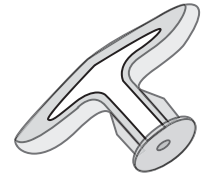

★ Made in USA

U.S. Patent Nos. 4,993,901 & 5,028,186 and foreign counterparts thereof and of 4,878,790. Other patents pending. TOGGLER is a worldwide registered trademark of Mechanical Plastics Corp.

EZ ANCORS™ • #8 ZINC ALLOY • FULL SIZED

• A one-piece self-drilling anchor.

		Best Merchandising Option					
		Cardboard Box		Gravity Feed Jar		Job Jar	
Size	Part #	Box Qty	Part #	Jar Qty/ Std Pk	Part #	Jar Qty	
#8 Zinc EZ Ancor <i>Screws not included.</i>	59510 ★	100	59510J ★	100/600	—		

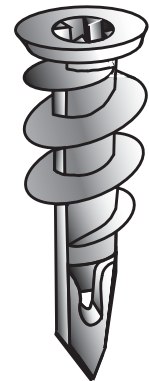

★ Made in USA

		Best Merchandising Option		
		Kits	Gravity Feed Jar	Job Jar
Description	Part #	Part #	Part #	
#8 EZ Ancor Sq/Phil Kit				
EZ Ancors Zinc (50 Pieces)	39915	39915J	39915-6	
#8 x 1 1/4 Sq/Phil Screws (50 Pieces)	(101 Piece Kit)	(101 Piece Kit)	(201 Piece Kit)	
#2-2" Hex Power Bit (1 Piece)				
#8 EZ Ancor Phil/Slot Kit				
EZ Ancors Zinc (50 Pieces)	39916	39916J	39916-6	
#8 x 1 1/4 Phil/Slot Screws (50 Pieces)	(101 Piece Kit)	(101 Piece Kit)	(201 Piece Kit)	
#2-2" Hex Power Bit (1 Piece)				
#8 EZ Ancor Slotted				
8 x 1 1/4 HWH SMS Slotted Screw (50 Pieces)	39925	▲		
E-Z Anchor Zinc-Plus (50 Pieces)	(101 Piece Kit)			
#2-2" Phil Hex Bit (1 Piece)				

▲ Contact customer service for gravity feed jar availability.

For bulk packaging, contact customer service for quantities and availability.

EZ ANCORS™ • #6–8 ZINC ALLOY • MINI

- A one-piece self-drilling anchor.

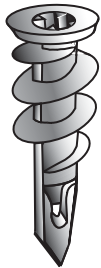

		Best Merchandising Option			
		Cardboard Box	Gravity Feed Jar	Job Jar	
Size	Part #	Box Qty	Part #	Jar Qty/ Std Pk	Part # Jar Qty
#6-8 Zinc EZ Mini Ancor <i>Screws not included.</i>	59512 ★	100	59512J ★	100/600	—

★ Made in USA

		Best Merchandising Option	
		Kits	Gravity Feed Jar
Description	Part #	Part #	
EZ Mini Ancor Square/Phillips Kit			
EZ Mini Ancors Zinc (50 Pieces) #6 x 1" Sq/Phil Screws (50 Pieces) #2-2" Hex Power Bit (1 Piece)	39928 (101 Piece Kit)	39928J (101 Piece Kit)	
EZ Mini Ancor Phillips/Slotted Kit			
EZ Mini Ancors Zinc (50 Pieces) #6 x 1" Phil/Slot Screws (50 Pieces) #2-2" Hex Power Bit (1 Piece)	39929 (101 Piece Kit)	39929J (101 Piece Kit)	
EZ Mini Ancor Phillips Fine Thread			
EZ Mini Ancors Zinc (50 Pieces) #6 x 1" Phillips Fine Thread Drywall Screws (50 Pieces) #2-2" Hex Power Bit (1 Piece)	39932 (101 Piece Kit)	▲	

▲ Contact customer service for gravity feed jar availability.

For bulk packaging, contact customer service for quantities and availability.

EZ ANCOR™ TRIPLE PACK • EZ ANCORS, EZ LITE & EZ TOGGLE

- A one-piece self-drilling anchor.

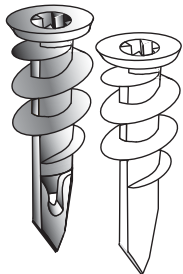

Kits	
Part #	Description
39930 (131 Pc Kit)	EZ Triple Pack Sq/Phil Combo 35 EZ Ancors Lites w/35 Screws 10 EZ Toggles w/10 Screws 20 Zinc EZ Ancors w/20 Screws #2-2" Hex Power Bit

Kits	
Part #	Description
39931 (131 Pc Kit)	EZ Triple Pack Slot/Phil Combo 35 EZ Ancors Lites w/35 Screws 10 EZ Toggles w/10 Screws 20 Zinc EZ Ancors w/20 Screws #2-2" Hex Power Bit

Get the Assortment You Need with the Triple Pack!

EZ ANCORS™ #8 WHITE PLASTIC • FULL SIZED

	Best Merchandising Option					
	Cardboard Box	Gravity Feed Jar	Job Jar			
Size	Part #	Box Qty	Part #	Jar Qty/ Std Pk	Part #	Jar Qty
#8 Plastic EZ Ancor <i>Screws not included.</i>	59515 ★	100	59515J ★	100/600	—	—

★ Made in USA

	Best Merchandising Option		
	Kits	Gravity Feed Jar	Job Jar
Size	Part #	Part #	Part #
#8 EZ Ancor Sq/Phil Kit			
Plastic EZ Ancors (50 Pieces)	39920 ★ (101 Piece Kit)	39920J ★ (101 Piece Kit)	39920-6 ★ (201 Piece Kit)
#8 x 1" Sq/Phil Screws (50 Pieces)			
#2-2" Hex Power Bit (1 Piece)			
#8 EZ Ancor Slot/Phil Kit			
Plastic EZ Ancors (50 Pieces)	39921 ★ (101 Piece Kit)	39921J ★ (101 Piece Kit)	39921-6 ★ (201 Piece Kit)
#8 x 1" Slot/Phil Screws (50 Pieces)			
#2-2" Hex Power Bit (1 Piece)			

★ Made in USA

EZ ANCORS™ #6 WHITE PLASTIC LITE • LITE

• A one-piece self-drilling anchor.

	Best Merchandising Option					
	Cardboard Box	Gravity Feed Jar	Job Jar			
Size	Part #	Box Qty	Part #	Jar Qty/ Std Pk	Part #	Jar Qty
#6 Plastic Lite EZ Ancor <i>Screws not included.</i>	59522 ★	100	59522J ★	100/600	—	—

★ Made in USA

	Best Merchandising Option	
	Kits	Gravity Feed Jar
Description	Part #	Part #
#6 EZ Ancor Sq/Phil Kit		
Plastic EZ Ancors (50 Pieces)	39922 (101 Piece Kit)	39922J (101 Piece Kit)
#6 x 1" Sq/Phil Screws (50 Pieces)		
#1-2" Hex Power Bit (1 Piece)		
#6 EZ Ancor Slot/Phil Kit		
Plastic EZ Ancors (50 Pieces)	39923 (101 Piece Kit)	39923J (101 Piece Kit)
#6 x 1" Slot/Phil Screws (50 Pieces)		
#1-2" Hex Power Bit (1 Piece)		

For bulk packaging, contact customer service for quantities and availability.

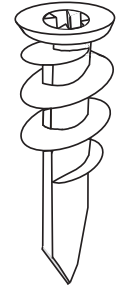

• A one-piece self-drilling anchor.

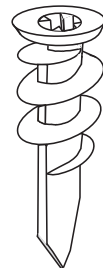

SnapSkru™ SP™ by TOGGLER® SELF-DRILLING DRYWALL ANCHORS

FASTENERS • ANCHORS



SnapSkru™ SP™ self-drilling drywall anchor locks on the wall.

- Self-drilling – no pre-drilled hole required.
- The anchors accept a wide range of screw sizes: #6, #8, and #10.
- Anchors “pop” open and lock positively on the rear of the wall to resist vibration and shock in walls and in ceilings.

- Installs with a screwdriver or screw gun.
- Unique tip prevents “walking” to ensure accurate and easy drilling.
- The unique, positive-stop built into the head of the anchor resists overturning and drive-through.
- Can remove screw and item, leaving anchor in wall for reuse.

Holding Power

- 1/2" Drywall holds 79 lbs
- 5/8" Drywall holds 135 lbs

RATED FOR OVERHEAD APPLICATIONS!

Applications

Securely hang bathroom accessories, mirrors, picture frames, lighting fixtures, drapery, smoke detectors, alarms, thermostats, electric boxes, and shelving.

Installation



1. Drive anchor clockwise into drywall until anchor stops flush with the wall.

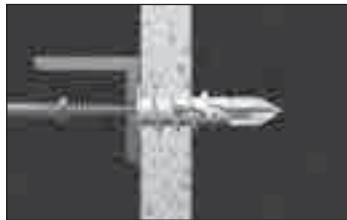

2. Place item over anchor and insert screw.

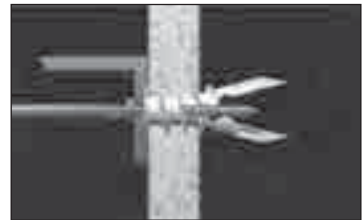

3. Tighten screw flush with item. Screw “pops” open anchor, locking anchor on wall.

		Best Merchandising Option
		Gravity Feed Jar
Description	Kits Part #	Part #
#8 SnapSkru™ Kit		
SnapSkru™ Anchors (40 Pieces)	39933	39933J
#8 x 1 1/2" Slot/Phil Screws (40 Pieces)	(80 Piece Kit)	(80 Piece Kit)

U.S. Patent Nos. 7,144,212 & 7,320,569 and foreign counterparts thereof. Other patents pending. TOGGLER and SnapSkru are worldwide registered trademarks of Mechanical Plastics Corp.

TOGGLER® ALLIGATOR® SOLID & HOLLOW WALL ANCHORS • PLASTIC

- Highly versatile plastic anchor molds to wall for a tight fit.

Application:

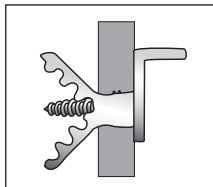

Great for use in:

- Cinder Block
- Concrete
- Masonry
- Stucco
- Drywall
- Brick
- Ceramic Tile
- Particle Board

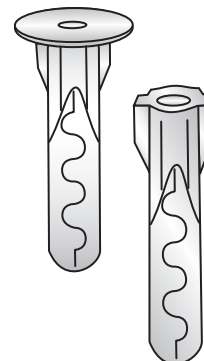

FASTENERS • ANCHORS

Best Merchandising Option

Description	Alligator #	Drill Size	Plastic Box		Gravity Feed Jar		Job Jar	
			Part #	Box Qty/Std Pk	Part #	Jar Qty/Std Pk	Part #	Jar Qty
#8-10 with Flange	AF5	3/16"	59411 ★	100/500	▲			
#10-12 with Flange	AF6	1/4"	59416 ★	50/250	59416J ★	50/300		
#12-14 with Flange	AF8	5/16"	59417 ★	*100	▲			
#8-10 without Flange	A6	1/4"	59418 ★	100/500	▲			

★ Made in USA

▲ Contact customer service for gravity feed jar availability.

*These items are packaged in cardboard boxes.

For bulk packaging, contact customer service for quantities and availability.



Kits

Part #	Description
#8-10 Alligator w/Square Drive Screws Includes 3/16" Carbide Bit	
39412	#8-10 Alligators (AF5) (50 Pieces) (101 Pc Kit) #8 x 1 1/4" Sq Dr Screws (50 Pieces)
#8-10 Alligator w/Hex Washer Head Screws Includes 3/16" Carbide Bit	
39414	#8-10 Alligators (AF5) (50 Pieces) (101 Pc Kit) #8 x 1 1/4" HWH Screws (50 Pieces)
#8-10 Alligator w/Slot/Phil Combo Screws Includes 3/16" Carbide Bit	
39411	#8-10 Alligators (AF5) (50 Pieces) (101 Pc Kit) #8 x 1 1/4" Combo Dr Screws (50 Pieces)
#10-12 Alligator w/Square Drive Screws Includes 1/4" Carbide Bit	
39415	#10-12 Alligators (AF6) (50 Pieces) (101 Pc Kit) #10 x 1 1/4" Sq Dr Screws (50 Pieces)
#10-12 Alligator w/Hex Washer Head Screws Includes 1/4" Carbide Bit	
39417	#10-12 Alligators (AF6) (50 Pieces) (101 Pc Kit) #10 x 1 1/4" HWH Screws (50 Pieces)



Kits

Part #	Description
#10-12 Alligator w/Slot/Phil Combo Screws Includes 1/4" Carbide Bit	
39422	#10-12 Alligators (AF6) (50 Pieces) (101 Pc Kit) #10 x 1 1/4" Combo Dr Screws (50 Pieces)
#12-14 Alligator w/Square Drive Screws Includes 5/16" Carbide Bit	
39418	#12-14 Alligators (AF8) (50 Pieces) (101 Pc Kit) #12 x 1 1/2" Sq Drive Screws (50 Pieces)
#12-14 Alligator w/Hex Washer Head Screws Includes 5/16" Carbide Bit	
39420	#12-14 Alligators (AF8) (50 Pieces) (101 Pc Kit) #12 x 1 1/2" HWH Screws (50 Pieces)
#12-14 Alligator w/Slot/Phil Combo Screws Includes 5/16" Carbide Bit	
39421	#12-14 Alligators (AF8) (50 Pieces) (101 Pc Kit) #12 x 1 1/2" Combo Dr Screws (50 Pieces)

U.S. Patent Nos. 5,161,296 & 5,938,385 and foreign counterparts thereof and of 4,752,170. Other patents pending. TOGGLER and SnapSku™ are worldwide registered trademarks of Mechanical Plastics Corp.

GREEN PLUG ANCHORS

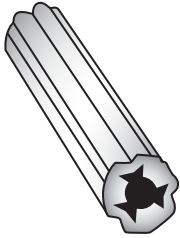

Description	Best Merchandising Option				
	Plastic Box		Gravity Feed Jar		Job Jar
	Part #	Qty	Part #	Jar Qty/ Std Pk	Part # Jar Qty
#10-12 Green Plug Anchor	59425 ★	100	59425J ★	100/600	—
#8-10-12 Green Plastic Anchor	59450 ★	100	▲		—

★ Made in USA



Kits

Part #	Description
39914 (201 Piece Kit)	#10-12 Green Plug Anchor with Hex Washer Head Screws #10 x 1" HWH Screws (100 Pieces) #10-12 Green Plug Anchor (100 Pieces) ¼" Carbide Bit

PAN HEAD WALL DOG ANCHORS

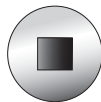

Size Drive Description			Best Merchandising Option				
			Plastic Box		Gravity Feed Jar		Job Jar
			Part #	Qty	Part #	Jar Qty/ Std Pk	Part # Jar Qty
Includes Drive Bit and 3/16" x 4" Masonry Hex Head Drill Bit							
1¼	Phillips	Zinc	59504	100	59504J	100/600	—
1¼	Phillips	White	59505	100	59505J	100/600	—
1¼	Square	Zinc	59506	100	59506J	100/600	—
1¼	Hex Washer Head Combo	Zinc	59507	100	59507J	100/600	—

▲ Contact customer service for gravity feed jar availability.

For bulk packaging, contact customer service for quantities and availability.

RED PLASTIC CONICAL ANCHORS

Installation

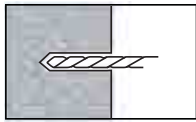

1. Drill proper size hole, 1/4" deeper than anchor length.

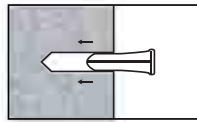

2. Insert anchor flush with surface of wall.

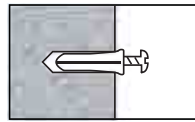

3. Insert wood or sheet metal screw through fixture and tighten.

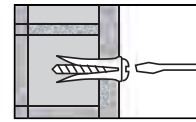

4. Anchor expands as wood or sheet metal screw is driven in.

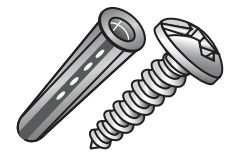

		Best Merchandising Option					
		Plastic Box	Gravity Feed Jar	Job Jar			
Description	Drill Size	Part #	Box Qty/Std Pk	Part #	Jar Qty/Std Pk	Part #	Jar Qty
#6-8 Red Conical	1/8"	59408 ★	100/500	59408J ★	100/600	—	—
#8-10 Red Conical	3/16"	59410 ★	100/500	59410J ★	100/600	—	—
#10-12 Red Conical	1/4"	59412 ★	100/500	59412J ★	100/600	—	—
#14-16 Red Conical	5/16"	59414 ★	*100	59414J ★	100/600	—	—

All plastic anchor Jars include a masonry drill bit.

*These items are packaged in cardboard boxes!

★ Made in USA

		Best Merchandising Option		
		Kits	Gravity Feed Jar	Job Jar
Description	Part #	Part #	Part #	Part #
#6 Slot/Phil Pan Head Red Conical Anchor Kit				
Includes 1/8" Carbide Bit				
#6 x 1" Screws (100 Pieces)	39816	39816J	—	—
#6-8 Anchors (100 Pieces)	(201 Piece Kit)	(201 Piece Kit)	—	—
#8 Square Drive Pan Head Red Conical Anchor Kit				
Includes 3/16" Carbide Bit				
#8 x 1" Screws (100 Pieces)	39708	▲	—	—
#8-10 Anchors (100 Pieces)	(201 Piece Kit)		—	—
#8 Slot/Phil Pan Head Red Conical Anchor Kit				
Includes 3/16" Carbide Bit				
#8 x 1" Screws (100 Pieces)	39818	39819	—	—
#8-10 Anchors (100 Pieces)	(201 Piece Kit)	(201 Piece Kit)	—	—
#8 Hex Washer Head Red Conical Anchor Kit				
Includes 3/16" Carbide Bit				
#8 x 1" Screws (100 Pieces)	39908	▲	—	—
#8-10 Anchors (100 Pieces)	(201 Piece Kit)		—	—

Continued on next page.

▲ Contact customer service for gravity feed jar availability.

For bulk packaging, contact customer service for quantities and availability.

RED PLASTIC CONICAL ANCHORS (CONT.)

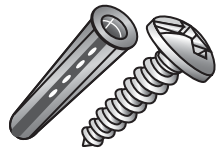

FASTENERS • ANCHORS

		Best Merchandising Option		
		Kits	Gravity Feed Jar	Job Jar
Description	Part #	Part #	Part #	
#10 Square Drive Pan Head Red Conical Anchor Kit Includes 1/4" Carbide Bit				
#10 x 1" Screws (100 Pieces)	39710	39711	39710-6	
#10-12 Anchors (100 Pieces)	(201 Piece Kit)	(201 Piece Kit)	(401 Piece Kit)	
#10 Slot/Phil Pan Head Red Conical Anchor Kit Includes 1/4" Carbide Bit				
#10 x 1" Screws (100 Pieces)	39820	39821	39820-6	
#10-12 Anchors (100 Pieces)	(201 Piece Kit)	(201 Piece Kit)	(401 Piece Kit)	
#10 Hex Washer Head Red Conical Anchor Kit Includes 1/4" Carbide Bit				
#10 x 1" Screws (100 Pieces)	39910	39911	39910-6	
#10-12 Anchors (100 Pieces)	(201 Piece Kit)	(201 Piece Kit)	(401 Piece Kit)	
#12 Slot/Phil Pan Head Red Conical Anchor Kit Includes 1/4" Carbide Bit				
#12 x 1" Screws (100 Pieces)	39822	39822J	—	
#10-12 Anchors (100 Pieces)	(201 Piece Kit)	(201 Piece Kit)		
#12 Hex Washer Head Red Conical Anchor Kit Includes 1/4" Carbide Bit				
#12 x 1" Screws (100 Pieces)	39912	▲	—	
#10-12 Anchors (100 Pieces)	(201 Piece Kit)			
#12 Square Drive Pan Head Red Conical Anchor Kit Includes 1/4" Carbide Bit				
#12 x 1" Screws (100 Pieces)	39712	▲	—	
#10-12 Anchors (100 Pieces)	(201 Piece Kit)			

▲ Contact customer service for gravity feed jar availability.

For bulk packaging, contact customer service for quantities and availability.

YELLOW WINGED ANCHORS • PLASTIC

		Best Merchandising Option					
		Plastic Box	Gravity Feed Jar	Job Jar			
Description	Drill Size	Part #	Box Qty/ Std Pk	Part #	Jar Qty/ Std Pk	Part #	Jar Qty
#4-6-8 Yellow Vinyl	3/16	59431 ★	100/500	59431J ★	100/600	—	—
#8-10-12 Yellow Vinyl	1/4	59432	50/250	59432J	100/600	—	—
#12-14-16 Yellow Vinyl	5/16	59433	*100	▲		—	—

★ Made in USA

		Best Merchandising Option		
		Kits	Gravity Feed Jar	Job Jar
Description	Part #	Part #	Part #	Part #
#8 Square Drive Pan Head Yellow Winged Anchor Kit – Includes 3/16" Carbide Bit				
#8 x 1" Screws (100 Pieces)	39717	39718	—	—
#4-6-8 Anchors (100 Pieces)	(201 Piece Kit)	(201 Piece Kit)		
#8 Hex Washer Head Yellow Winged Anchor Kit – Includes 3/16" Carbide Bit				
#8 x 1" Screws (100 Pieces)	39747	39748	—	—
#4-6-8 Anchors (100 Pieces)	(201 Piece Kit)	(201 Piece Kit)		
#8 Slot/Phil Pan Head Yellow Winged Anchor Kit – Includes 3/16" Carbide Bit				
#8 x 1" Screws (100 Pieces)	39756	39759	—	—
#4-6-8 Anchors (100 Pieces)	(201 Piece Kit)	(201 Piece Kit)		
#10 Square Drive Pan Head Yellow Winged Anchor Kit – Includes 1/4" Carbide Bit				
#10 x 1" Screws (100 Pieces)	39721	39723	39723-6	—
#8-10-12 Anchors (100 Pieces)	(201 Piece Kit)	(201 Piece Kit)	(201 Piece Kit)	
#10 Hex Washer Head Yellow Winged Anchor Kit – Includes 1/4" Carbide Bit				
#10 x 1" Screws (100 Pieces)	39751	39753	39753-6	—
#8-10-12 Anchors (100 Pieces)	(201 Piece Kit)	(201 Piece Kit)	(401 Piece Kit)	
#10 Slot/Phil Pan Head Yellow Winged Anchor Kit – Includes 1/4" Carbide Bit				
#10 x 1" Screws (100 Pieces)	39761	39763	39763-6	—
#8-10-12 Anchors (100 Pieces)	(201 Piece Kit)	(201 Piece Kit)	(401 Piece Kit)	
#12 Square Drive Pan Head Yellow Winged Anchor Kit – Includes 5/16" Carbide Bit				
#12 x 1 1/2" Screws (50 Pieces)	39722	39724	—	—
#12-14-16 Anchors (50 Pieces)	(101 Piece Kit)	(101 Piece Kit)		
#12 Hex Washer Head Yellow Winged Anchor Kit – Includes 5/16" Carbide Bit				
#12 x 1 1/2" Screws (50 Pieces)	39752	39754	—	—
#12-14-16 Anchors (50 Pieces)	(101 Piece Kit)	(101 Piece Kit)		
#12 Slot/Phil Pan Head Yellow Winged Anchor Kit – Includes 5/16" Carbide Bit				
#12 x 1 1/2" Screws (50 Pieces)	39762	39764	—	—
#12-14-16 Anchors (50 Pieces)	(101 Piece Kit)	(101 Piece Kit)		

▲ Contact customer service for gravity feed jar availability.

* These items are packaged in cardboard boxes.

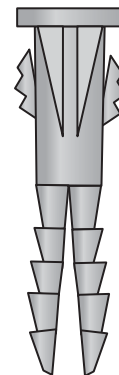

For bulk packaging, contact customer service for quantities and availability.

EXPANDER ANCHORS • PLASTIC

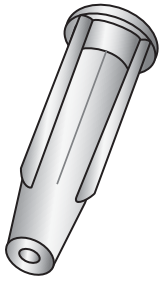

Description	Cardboard Box		Gravity Feed Jar		Job Jar	
	Part #	Box Qty	Part #	Jar Qty/ Std Pk	Part #	Jar Qty
#8-10 Expander Anchors	59440 ★	100	▲		—	

▲ Contact customer service for gravity feed jar availability.

★ Made in USA

For bulk packaging, contact customer service for quantities and availability.

Description	Best Merchandising Option	
	Part #	Jar Qty/ Std Pk
#8 Square Drive Pan Head Expander Anchor Kit Includes 1/4" Carbide Bit	Gravity Feed Jar	
#8 Expander Anchor (100 Pieces) 8 x 1 1/2" Screws (100 Pieces)	39727	(201 Piece Kit)
#10 Square Drive Pan Head Expander Anchor Kit Includes 1/4" Carbide Bit	Gravity Feed Jar	
#10 Expander Anchor (100 Pieces) 10 x 1 1/2" Screws (100 Pieces)	39728	(201 Piece Kit)
#8 Hex Washer Head Expander Anchor Kit Includes 1/4" Carbide Bit	Gravity Feed Jar	
#8 Expander Anchor (100 Pieces) 8 x 1 1/2" Screws (100 Pieces)	39757	(201 Piece Kit)
#10 Hex Washer Head Expander Anchor Kit Includes 1/4" Carbide Bit	Gravity Feed Jar	
#10 Expander Anchor (100 Pieces) 10 x 1 1/2" Screws (100 Pieces)	39758	(201 Piece Kit)
#8 Phillips/Slotted Pan Head Expander Anchor Kit Includes 1/4" Carbide Bit	Gravity Feed Jar	
#8 Expander Anchor (100 Pieces) 8 x 1 1/2" Screws (100 Pieces)	39767	(201 Piece Kit)
#10 Phillips/Slotted Pan Head Expander Anchor Kit Includes 1/4" Carbide Bit	Gravity Feed Jar	
#10 Expander Anchor (100 Pieces) 10 x 1 1/2" Screws (100 Pieces)	39768	(201 Piece Kit)

HANGERBOLTS • ZINC

- Bolt with threaded areas at both ends, lag screw thread at one end and unified thread at the other.
- Standard hanger bolts insert into a predrilled pilot hole.
- The end of the wood thread tapers is threaded all the way to its blunt tip.



		Best Merchandising Option					
		Cardboard Box		Gravity Feed Jar		Job Jar	
Size	Part #	Box Qty	Part #	Jar Qty/ Std Pk	Part #	Jar Qty	
¼ x 1½	66124	100	66124J	100/600	—	—	
¼ x 2	66132	100	66132J	100/600	—	—	
¼ x 2½	66140	100	▽		—	—	
¼ x 3	66148	100	66148J	100/600	—	—	
¼ x 4	66164	100	▽		—	—	
⅜ x 2½	66340	100	▽		—	—	
⅜ x 3	66348	50	66348J	50/300	—	—	
⅜ x 3½	66356	50	▽		—	—	
⅜ x 4	66364	50	▽		—	—	

▲ Contact customer service for gravity feed jar availability.

For bulk packaging, contact customer service for quantities and availability.

HANGERBOLT DRIVERS

- Driver has internal threads with an easy release ball bearing at the bottom to relax easily, saving time.

		Plastic Bag	
Size	Part #	Qty	
¼-20 x 2 ⁹ / ₁₆	39101	1	
5 ¹ / ₁₆ -18 x 2 ⁹ / ₁₆	39102	1	
3 ⁸ / ₁₆ -16 x 2 ⁹ / ₁₆	39103	1	



SAMMYS® FOR WOOD • VERTICAL MOUNTING

Application



Best Merchandising Option

Size	Model	Approvals	Rod Size	Nut Driver	Cardboard Box		Gravity Feed Jar		Job Jar	
					Part #	Box Qty/Case Qty	Part #	Jar Qty/Std Pk	Part #	Jar Qty
¼ x 1	GST 100	—	¼	61192	61144 ★	25/125	61144J ★	25/150	—	—
¼ x 2	GST 200	—	¼	61192	61145 ★	25/125	61145J ★	25/150	—	—
¼ x 1	GST 10	UL	⅜	61192	61147 ★	25/125	61147J ★	25/150	—	—
¼ x 2	GST 20	UL • FM	⅜	61192	61148 ★	25/125	61148J ★	25/150	—	—
¼ x 3	GST 30	UL • FM	⅜	61192	61150 ★	25/125	61150J ★	25/150	—	—
¼ x 2	GST 2	—	½	61193	61152 ★	25/125	61152J ★	25/150	—	—
⅜ x 2½	GST25-380	UL • FM	⅜	61192	61182 ★	25/125	61182J ★	25/150	—	—

★ Made in USA

Nut Drivers



#61192 (Black) #61193 (Red)

FASTENERS • HANGERS

SAMMYS® FOR WOOD • HORIZONTAL MOUNTING

Application



Best Merchandising Option

Size	Model	Approvals	Rod Size	Nut Driver	Cardboard Box		Gravity Feed Jar		Job Jar	
					Part #	Box Qty/Case Qty	Part #	Jar Qty/Std Pk	Part #	Jar Qty
¼ x 1	SWG 100	—	¼	61193	61154 ★	25/125	61154J ★	25/150	—	—
¼ x 1	SWG 10	UL	⅜	61193	61156 ★	25/125	61156J ★	25/150	—	—
¼ x 2	SWG 20	UL	⅜	61193	61157 ★	25/125	61157J ★	25/150	—	—
⅜ x 2½	SWG 25-380	UL	⅜	61193	61183 ★	25/125	61183J ★	25/150	—	—

★ Made in USA

SAMMYS® FOR STEEL • VERTICAL MOUNTING

					Best Merchandising Option					
					Cardboard Box	Gravity Feed Jar			Job Jar	
Size	Model	Approvals	Rod Size	Nut Driver	Part #	Box Qty/ Case Qty	Part #	Jar Qty/ Std Pk	Part #	Jar Qty
¼-20 x 1	DSTR 100	—	¼	61192	61160 ★	25/125	61160J ★	25/150	—	—
¼-14 x 2	DST 200	—	¼	61192	61162 ★	25/125	61162J ★	25/150	—	—
⅝-18 X 1¼	DSTR 516	UL • FM	⅜	61192	61166 ★	25/125	61166J ★	25/150	—	—
12-24 x 1½	DSTR 1½	UL • FM	⅜	61192	61168 ★	25/125	61168J ★	25/150	—	—
¼-20 x 1	DSTR 1	UL • FM	⅜	61192	61169 ★	25/125	61169J ★	25/150	—	—
¼-14 x 1	DST 10	—	⅜	61192	61170 ★	25/125	61170J ★	25/150	—	—
¼-14 x 2	DST 20	—	⅜	61192	61172 ★	25/125	61172J ★	25/150	—	—
12-24 x 1½	TEK 50	UL • FM	⅜	61192	61174 ★	25/125	61174J ★	25/150	—	—
¼-14 x 2	DST 2.0	—	½	61193	61164 ★	25/125	61164J ★	25/150	—	—
¼-20 x 1	DSTR 1.0	—	½	61193	61165 ★	25/125	61165J ★	25/150	—	—
12-24 x 1½	TEK 5.0	—	½	61193	61167 ★	25/125	61167J ★	25/150	—	—

★ Made in USA



Application

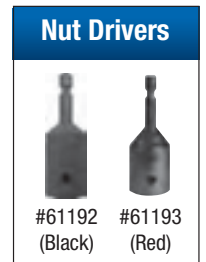

#61192 (Black) #61193 (Red)

FASTENERS • HANGERS

SAMMYS® FOR STEEL • HORIZONTAL MOUNTING

					Best Merchandising Option					
					Cardboard Box	Gravity Feed Jar			Job Jar	
Size	Model	Approvals	Rod Size	Nut Driver	Part #	Box Qty/ Case Qty	Part #	Jar Qty/ Std Pk	Part #	Jar Qty
¼-14 x 1	SWD 100	—	¼	61193	61175 ★	25/125	61175J ★	25/150	—	—
¼-20 x 1	SWDR 100	—	¼	61193	61176 ★	25/125	61176J ★	25/150	—	—
¼-14 x 1	SWD 10	—	⅜	61193	61177 ★	25/125	61177J ★	25/150	—	—
¼-14 x 2	SWD 20	—	⅜	61193	61179 ★	25/125	61179J ★	25/150	—	—
⅝-18 X 1¼	SWDR 516	—	⅜	61193	61180 ★	25/125	61180J ★	25/150	—	—
¼-20 x 1½	SWDR 1½	UL • FM	⅜	61193	61181 ★	25/125	61181J ★	25/150	—	—

★ Made in USA



Application



SAMMYS® FOR CONCRETE • VERTICAL MOUNTING

Application



					Best Merchandising Option					
					Cardboard Box	Gravity Feed Jar		Job Jar		
Size	Model	Approvals	Rod Size	Nut Driver	Part #	Box Qty/ Case Qty	Part #	Jar Qty/ Std Pk	Part #	Jar Qty
5/16 x 1 3/4	CST 200	—	1/4	61192	61185 ★	25/125	61185J ★	25/150	—	—
5/16 x 1 3/4	CST 20	FM	3/8	61192	61186 ★	25/125	61186J ★	25/150	—	—
5/16 x 1 3/4	CST 2	—	1/2	61193	61187 ★	25/125	61187J ★	25/150	—	—

★ Made in USA

SAMMYS® FOR CONCRETE • HORIZONTAL MOUNTING

Application



					Best Merchandising Option					
					Cardboard Box	Gravity Feed Jar		Job Jar		
Size	Model	Approvals	Rod Size	Nut Driver	Part #	Box Qty/ Case Qty	Part #	Jar Qty/ Std Pk	Part #	Jar Qty
5/16 x 1 3/4	SWC 20	—	3/8	61193	61188 ★	25/125	61188J ★	25/150	—	—

FASTENERS • HANGERS

Nut Drivers



#61192 (Black) #61193 (Red)

Kits



Part #	Description		
61190 ★	Concrete Installation Kit		
(7 Piece Kit)	#250 – Bit (1/4")	SDS 250 Bit (1/4")	7/32" Wood Bit
	Hex 250 – Bit Receiver (1/4")	#14 Nut Driver	#14 SW Nut Driver
	SL 250 – Sleeve		

★ Made in USA

SAMMY® X-PRESS • USE WITH ¼" OR ⅜" ROD



Application



U.S. Patent
No. 6,935,821

Sammy X-Press
(for vertical attachment)



Application



Sammy X-Press Sidewinder
(for horizontal attachment)
#61202



- Pipe Hanger for X-Treme Roof Pitches.
 - 89° in purlin
 - 45° in metal deck for 12/12 pitch
- Installs in seconds, saves time and installation costs.
- Use in applications where easy access to the back of the installed faster is prohibited.
- No retaining nut required.



Universal X-Press It®
Installation Tool
#61200

							Best Merchandising Option			
							Cardboard Box	Gravity Feed Jar		
Description	Model	Rod Size	Max Pipe Size	Steel Gauge	Approvals	Application	Part #	Box Qty/ Case Qty	Part #	Jar Qty/ Std Pk
Sammy X-Press 20	XP 20	⅜-16	4	12	FM	Metal Deck	61194 ★	25/125	61194J ★	25/150
Sammy X-Press 35	XP 35	⅜-16	4	12	FM	Purlin	61197 ★	25/125	61197J ★	25/150
Sidewinder X-Press 35	SWXP 35	⅜-16	3½	16-12	UL	Purlin	61202 ★	25/125	61202J ★	25/150
Swivel X-Press 20	SXP 20	⅜-16	2	22-20	UL	Metal Deck	61203 ★	25/125	61203J ★	25/150
Swivel X-Press 35	SXP 35	⅜-16	3½	16-12	UL	Purlin	61204 ★	25/125	61204J ★	25/150
Sammy X-Press 200	XP 200	¼-20	185 lbs*	—	UL	Metal Deck	61198 ★	25/125	61198J ★	25/150
Universal X-Press It Tool	UXPIT	—	—	—	—	—	61200 ★	1	▲	
Replacement Bit for 61200		—	—	—	—	—	61201 ★	1	▲	
Retro Socket	RXPIT	—	—	—	—	—	61195 ★	1	▲	

*Load Rating.

★ Made in USA

HANGERMATE® • METAL APPLICATIONS

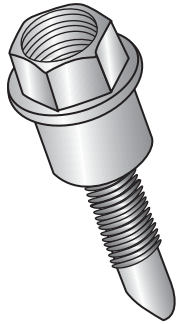

- Installs easily in metal up to 1/4" thick.
- Yellow dichromate finish provides outstanding corrosion protection.
- Requires no pre-drilling and is quick to install.

		Best Merchandising Option					
		Cardboard Box		Gravity Feed Jar		Job Jar	
Threaded Size	OAL	Part #	Box Qty	Part #	Jar Qty/ Std Pk	Part #	Jar Qty
1/4-20	1 7/8	59614 ★	50	59614J ★	50/300	—	—
3/8-16	1 7/8	59616 ★	50	59616J ★	50/300	—	—

★ Made in USA

Starter Kit

Part #	Description		
59643 ★ (21 Piece Kit)	Hangermate® Metal Drilling Kit		
	1/4" Self-Drilling Anchors (10 Pieces)	3/8" Self-Drilling Anchors (10 Pieces)	3/8" Recessed Drive Socket (1 Piece)

★ Made in USA

HANGERMATE® • WOOD APPLICATIONS

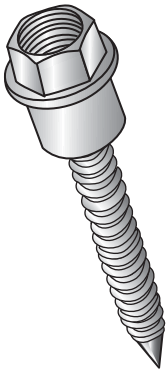

- Tapped to accept 1/4-20 and 3/8-16 threaded rod.
- Yellow dichromate finish for outstanding corrosion protection.
- Installs easily with insert socket.

		Best Merchandising Option					
		Cardboard Box		Gravity Feed Jar		Job Jar	
Threaded Size	OAL	Part #	Box Qty	Part #	Jar Qty/ Std Pk	Part #	Jar Qty
1/4-20	2 1/2	59615 ★	50	59615J ★	50/300	—	—
3/8-16	2 1/2	59617 ★	50	59617J ★	50/300	—	—

★ Made in USA

Starter Kit

Part #	Description		
59645 ★ (21 Piece Kit)	Hangermate® Wood Drilling Kit		
	1/4" Wood-Drilling Anchors (10 Pieces)	3/8" Wood-Drilling Anchors (10 Pieces)	3/8" Recessed Drive Socket (1 Piece)

★ Made in USA

HANGERMATE® BRUTES • SIDEMOUNT APPLICATIONS

- Tapped to accept 3/8"-16 threaded rod.
 - New sidemount configuration offers added convenience.
- Requirements:**
- Driver required. Order part #59620.

			Best Merchandising Option				
			Cardboard Box	Gravity Feed Jar	Job Jar		
Description	Application	OAL	Part #	Box Qty	Part #	Jar Qty/ Std Pk	Part # Jar Qty
3/8"-16 Brute Sidemount	Metal	2 3/4"	59613 ★	50	59613J ★	50/300	—
3/8"-16 Brute Sidemount	Wood	2 3/4"	59618 ★	50	▲		—

▲ Contact customer service for gravity feed jar availability. ★ Made in USA

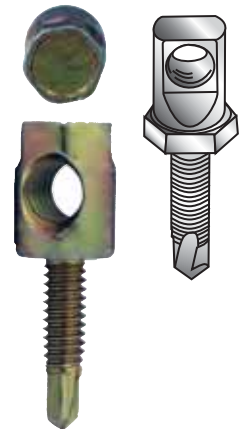

HANGERMATE® INSTALLATION TOOLS

Description	Part #	Qty
Hangermate® Driver (ZE 215)	59620 ★	1

★ Made in USA

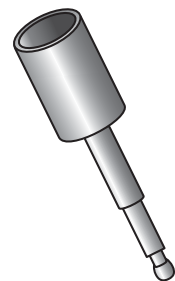

FASTENERS • HANGERS

THREADED ROD

Zinc		
Size	Part #	Tube Qty
1/4-20 x 3'	59703	50
3/8-16 x 3'	59702	25
1/4-20 x 6'	59704	50
5/16-18 x 6'	59705	35
3/8-16 x 6'	59706	25
1/2-13 x 6'	59708	12
5/8-11 x 6'	59710	5
1/4-20 x 10'	59804	50
5/16-18 x 10'	59805	35
3/8-16 x 10'	59806	25
1/2-13 x 10'	59808	12
5/8-11 x 10'	59810	5

Stainless Steel		
Size	Part #	Tube Qty
1/4-20 x 3'	71931 ♡	50
5/16-18 x 3'	71932 ♡	35
3/8-16 x 3'	71933 ♡	25
1/2-13 x 3'	71934 ♡	36
1/4-20 x 6'	71961 ♡	50
5/16-18 x 6'	71962 ♡	35
3/8-16 x 6'	71963 ♡	25
1/2-13 x 6'	71964 ♡	12
1/4-20 x 12'	71921 ♡	50
5/16-18 x 12'	71922 ♡	35
3/8-16 x 12'	71923 ♡	25
1/2-13 x 12'	71924 ♡	12

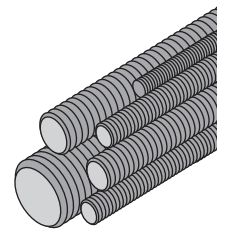

- When shipping an order including 10' lengths and over, minimum freight pre-pay is \$1,000.
- Rod is sold per piece, not per foot.

Dimension All Thread Rod (ATR)

- Dimensions taken from ANSI B1.1-1982 Unified Inch Screw Threads.
- All threads are UNCR series.
- Tabulated loads are based on an allowable tensile stress of 12000 psi (82.7 MPa) reduced by 25% resulting in 9000 psi (62 MPa). From ANSI/MSS SP-58, Table 3.

Nominal Size & Thread	Root Area		Design Load (SF=5)	
	in. ²	cm ²	lbs	kN
1/4 - 20	0.027	0.174	240	1.07
5/16 - 18	0.045	0.290	400	1.78
3/8 - 16	0.068	0.438	610	2.71

♡ Harsh Environment Product

HEX ROD & REDUCING COUPLINGS • ZINC

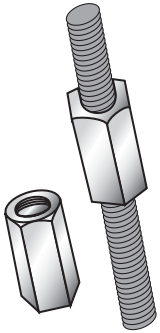

				Best Merchandising Option	
				Cardboard Box	Gravity Feed Jar
Size	Couplings	Part #	Box Qty	Part #	Jar Qty/ Std Pk
1/4-20 x 7/8	Hex Rod	59604	100	59604J	100/600
5/16-18 x 7/8	Hex Rod	59605	100	▲	
3/8-16 x 1-1/8	Hex Rod	59606	100	59606J	100/600
1/2-13 x 1 3/4	Hex Rod	59608	50	59608J	50/300
1/4-20 to 3/8-16	Reducing	59625	50	59625J	50/300
3/8-16 to 1/2-13	Reducing	59626	50	59626J	50/300

▲ Contact customer service for gravity feed jar availability.

For bulk packaging, contact customer service for quantities and availability.

FASTENERS • HANGERS

TIE WIRE



				Cardboard Box	
Description	Gauge	Length	Weight (lbs)	Part #	Box Qty
Tie Wire (Steel Black Annealed Coil)	#16	340'	3 1/2	71000	20 Coils
Tie Wire (Galvanized Coil)	#16-1/2	450'	4	71001	20 Coils
Ceiling Tie Wire (Galvanized Length)	#12,5	10'	—	69950 ★	100 Pcs/ Bundle

★ Made in USA

JACK CHAIN • ZINC PLATED

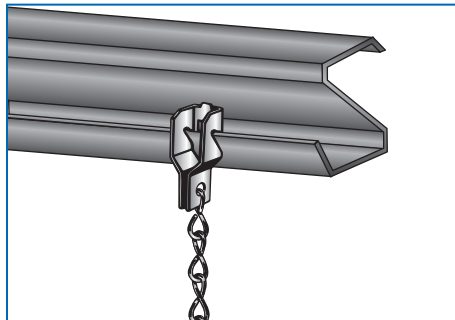

- For support of light fixtures and signs.
- Zinc plated steel.

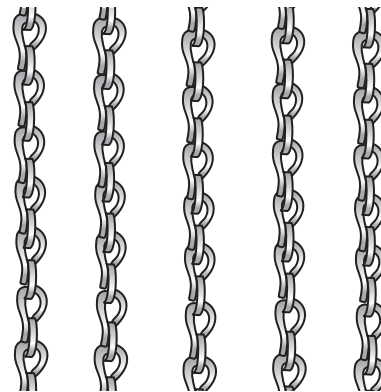

		Cardboard Box	Reel	Bucket			
Work Load Limit (lbs)	Gauge	Part #	Box Qty	Part #	Reel Qty	Part #	Bucket Qty
48	#10	72011 ★	100'	72010 ★	100'	72018 ★	300'
29	#12	72013 ★	100'	72012 ★	100'	72020 ★	300'
16	#14	72015 ★	100'	72014 ★	200'	—	—
11	#16	—	—	72016 ★	250'	—	—

★ Made in USA

JACK CHAIN • STAINLESS STEEL

		Cardboard Box	
Work Load Limit (lbs)	Gauge	Part #	Box Qty
43	#10	72010SS ★ ♠	100'
29	#12	72012SS ★ ♠	100'

★ Made in USA

♠ Harsh Environment Product

DOUBLE LOOP TENSO CHAIN • ZINC PLATED

			Reel	
Work Load Limit (lbs)	Gauge	Size	Part #	Box Qty
255	#10	2/0	74002 ★	175'
200	#10	1/0	74010 ★	100'
155	#12	1	74011 ★	200'
90	#14	3	74013 ★	200'
90	#14	3	74014 ★	100'

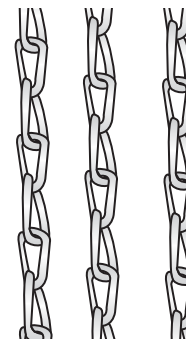

Sold by box/pkg (not by foot)

★ Made in USA

PLUMBER'S TAPE (PERFORATED STRAP IRON) • GALVANIZED & COPPER

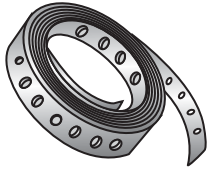

Gauge	Type	Width	Length	Part #	Unit	Std Pack
22	Galvanized	3/4"	10'	94422 ★	1	100 Rolls
24	Copper	3/4"	10'	94430 ★	1	100 Rolls
28	Galvanized	3/4"	10'	94428 ★	1	100 Rolls
26	Galvanized	3/4"	10'	94426 ★	1	100 Rolls

★ Made in USA

S-HOOKS • ZINC



- For hanging Jack Chain to various overhead hangers.
- Made from pre-galvanized steel.

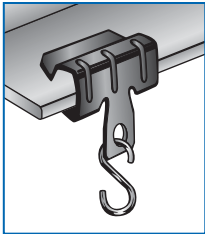



Size	Cardboard Box		Best Merchandising Option		Job Jar	
	Part #	Qty	Part #	Jar Qty/Std Pk	Part #	Jar Qty
3/4"	70012 ★	100	70012J ★	100/600	—	—
1"	70016 ★	100	70016J ★	100/600	—	—
1 1/4"	70020 ★	100	70020J ★	100/600	—	—
1 1/2"	70024 ★	100	70024J ★	100/600	—	—
2"	70032 ★	50	70032J ★	100/600	—	—
2 1/2"	70040 ★	50	70040J ★	100/600	—	—
3"	70048 ★	50	70048J ★	50/300	—	—

★ Made in USA

V-HOOKS • FLUORESCENT FIXTURE HANGERS • ZINC

- For use with fluorescent lighting fixtures holding 2, 3, or 4 bulbs.



Side Mount 			Top/End Mount 		
Size	Part #	Qty	Size	Part #	Qty
10 Gauge	70000 ★	50	10 Gauge	70002 ★	50

★ Made in USA

KRYLON® INDUSTRIAL QUIK-MARK™ INVERTED MARKING PAINT



- Make a mark fast in all types of wind and weather.
- A heavy-duty industrial paint.
- Fast drying, high solids formula that penetrates and adheres to hot and cold surfaces.
- Features exclusive Spray-Thru™ cap and non-clogging spray tip.
- Available in APWA colors (American Public Works Association) and fluorescent colors.
- VOC-compliant and lead free.
- Solvent-Based paints are the best choice for cool or damp conditions.
- Water-Based paints are best suited for hot and dry conditions.
- See the Color Selection Guide on page 112.



**Know what's below.
Call before you dig.**

Uses:

- Ground Surveying
- Construction Marking
- Excavation
- Utility

Description	Base Type	MSDS REF #	Part #	Can Size	Net Fill	Std Pk
Fluorescent Safety Red	Water-Based	S03610	37681 ★	20 oz	17 oz	12
Fluorescent Safety Green	Water-Based	S03630	37459 ★	20 oz	17 oz	12
Fluorescent Orange	Water-Based	S03700	37460 ★	20 oz	17 oz	12
Fluorescent Pink	Water-Based	S03612	37655 ★	20 oz	17 oz	12
Brilliant White APWA	Water-Based	S03901	37461 ★	20 oz	17 oz	12
Utility Yellow APWA	Water-Based	S03801	37462 ★	20 oz	17 oz	12
Fluorescent Red/Orange	Water-Based	S03650	37463 ★	20 oz	17 oz	12
Fluorescent Caution Blue	Water-Based	S03620	37465 ★	20 oz	17 oz	12
Clear	Water-Based	S03500	37466 ★	20 oz	17 oz	12
Red APWA	Solvent-Based	S03611	37455 ★	20 oz	17 oz	12
Hi-Vis Yellow APWA	Solvent-Based	S03821	37467 ★	20 oz	17 oz	12
Fluorescent Orange	Solvent-Based	S03702	37468 ★	20 oz	17 oz	12
Utility White APWA	Solvent-Based	S03900	37469 ★	20 oz	17 oz	12
Fluorescent Red/Orange	Solvent-Based	AT3701	37470 ★	20 oz	17 oz	12
Blue APWA	Solvent-Based	S03621	37471 ★	20 oz	17 oz	12
Green APWA	Solvent-Based	S03631	37472 ★	20 oz	17 oz	12
Fluorescent Hot Pink	Solvent-Based	S03622	37482 ★	20 oz	17 oz	12
Clear	Solvent-Based	S03600	37647 ★	20 oz	17 oz	12

★ Made in USA

You can find access to all current MSDS sheets on the Krylon Products Group website.

www.KPG-Industrial.com

COLOR SELECTION GUIDE • INVERTED MARKING PAINT

Application	Color	Water-Based Cully Part #	Solvent-Based Cully Part #
Electric Power Lines, Cables, Conduit and Lighting Cables	Fluorescent Red/Orange	37463 ★	37470 ★
	Red APWA	—	37455 ★
	Fluorescent Red	37681 ★	—
Gas, Oil, Steam, Petroleum or Gaseous Materials	Utility Yellow APWA	37462 ★	—
Communication, Alarm or Signal Lines, Cables or Conduit	Fluorescent Orange	37460 ★	37468 ★
Potable Water	Fluorescent Caution Blue	37465 ★	—
	Blue APWA	—	37471 ★
Sewers and Drain Lines	Fluorescent Safety Green	37459 ★	—
	Green APWA	—	37472 ★
Temporary Survey Markings	Fluorescent Hot Pink	37655 ★	37482 ★
Proposed Excavation	Brilliant White APWA	37461 ★	—
	Utility White APWA	—	37469 ★
General Purpose and Chalk Line Extender	Clear	37466 ★	37647 ★
Roads, Highway Pavement	Hi-Visibility Yellow APWA	—	37467 ★

★ Made in USA

PAINT ACCESSORIES

Description	Compatibility	MSDS Ref #	Part #	Unit
Wheeler Hand-Held Wand (34" Length)	Inverted Marking Paint (20 oz or 16 oz Cans)	K07096	37456 ★	1
Can Holster	Inverted Marking Paint (20 oz or 16 oz Cans)	K08000000	37457 ★	1
Snap & Spray™ Can Adapter	Aerosol Paint Cans	K07099	37458 ★	12

★ Made in USA

Marking Wand

37456 ★

- Constructed of durable, rugged plastic and lightweight steel.
- Comfortable pistol grip for easy handling and marking.
- Apply a uniform 1" to 1½" width of paint.
- Can Holster also available.

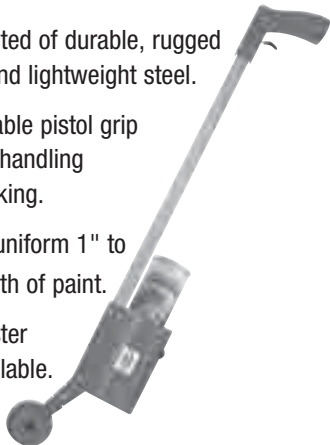

Can Holster

37457 ★

- Specially designed for holding inverted marking paint cans.
- Features rugged holster.
- Measures: 3½" diameter x 6½" high.

★ Made in USA



Can Adapter

37458 ★

- Transforms any standard spray can of paint, cleaner or lubricant into a spray gun.
- Snaps easily onto can rim.
- Eliminates finger fatigue.
- Trigger lock prevents accidental use.



KRYLON® INDUSTRIAL TOUGH COAT® ACRYLIC ENAMEL PAINT

Description	MSDS Ref #	Part #	Can Size	Net Fill	Std Pk
OSHA Safety Green	S01470	37473 ★	16 oz	12 oz	12
OSHA Black	S01770	37474 ★	16 oz	12 oz	12
OSHA White	S01800	37475 ★	16 oz	12 oz	12
OSHA Yellow	S01310	37476 ★	16 oz	12 oz	12
Semi-Flat Black	S03725	37477 ★	16 oz	12 oz	12
Max Flat Black	S03727	37478 ★	16 oz	12 oz	12
OSHA Red	S01110	37479 ★	16 oz	12 oz	12
OSHA Blue	S01510	37480 ★	16 oz	12 oz	12
OSHA Orange	S01210	37481 ★	16 oz	12 oz	12
Machinery Dark Gray (ASA-49)	S00325	37485 ★	16 oz	12 oz	12
Medium Gray	S01615	37486 ★	16 oz	12 oz	12
Industrial Gray	S01630	37487 ★	16 oz	12 oz	12
Light Gray	S01645	37488 ★	16 oz	12 oz	12
Blue/Gray	S01625	37489 ★	16 oz	12 oz	12
Machinery Gray	S01620	37490 ★	16 oz	12 oz	12
Machine Blue/Gray (ASA-24)	S00329	37491 ★	16 oz	12 oz	12
Machinery Light Gray (ASA-61)	S00326	37492 ★	16 oz	12 oz	12

★ Made in USA

- Features patented EZ Touch™ fan spray nozzle that requires 50% less finger pressure than most other paint valves.
- Ideal for light to heavy duty painting projects, both indoors and outdoors.
- Tough, protective coating resists chipping and peeling.
- Excellent hiding characteristics.
- Low odor and VOC-compliant
- Dries to the touch in 15 minutes.

Uses:

- Metal
- Motors
- Tools
- Machinery
- Railings & Electrical Equipment



You can find access to all current MSDS sheets on the Krylon Products Group website.

www.KPG-Industrial.com

CONTACT CLEANER SELECTION GUIDE

Chemical Properties

Product Description/ Part #	O.K. for These Substrates						Removes These Contaminants					Chemical Properties			
	Metals	Polycarb.	ABS	Nylon	Teflon	PVC	Light Oil	Flux	Solder	Rosin	Dust	Flash Point	Drying Time	Dielectric Strength	Plastic Safe
Electro Wizard 37680	X	X	X	X	X	X	B	A	A	A	B	None	Very Fast	12,500	Yes
Plastics Contact Cleaner 37504	X	X	X	X	X	X	B	C	—	C	B	None	Very Fast	19,000	Yes
Electronic Contact Cleaner 37506	X	X	X	X	X	X	A	A	A	A	A	None	Fast	N/A	Yes

A = Strong Cleaning Action

B = Good Cleaning Action

C = Moderate Cleaning Action

Is maximum solvency your main concern?

Yes, and I need a high Dielectric Strength as well.

**Plastics
Contact Cleaner**

37504

Yes, and I accept a lower Dielectric Strength if it costs less.

**3-2-1
Contact Cleaner**

37680

Do you require a non-chlorinated product?

Yes, and I'm not concerned with flammability.

**Environmental
Cleaner/Degreaser**

37501

Are you seeking an economical cleaner?

Yes, and I want a non-chlorinated product.

**Environmental
Contact Cleaner**

37506

Are you looking for the best Plastics Contact Cleaner?

Yes, and I'm not concerned about the price.

**Plastics
Contact Cleaner**

37504

Is High Dielectric Strength your main concern?

Yes, and I want no flash point.

**Plastics
Contact Cleaner**

37504

CONTACT CLEANER SELECTION GUIDE

Chemical Properties																
Product Description/ Part #	O.K. for These Substrates						Removes These Contaminants						Chemical Properties			
	Fiberglass	Plastic	Rubber	Teflon	Metal	Nylon	Tar/Asphalt	Grease	Ink	Wax	Adhesives	Carbon Dust	Flash Point	Drying Time	Dielectric Strength	Plastic Safe
Flash Free Safety Solvent 37497/37498	—	X	X	X	X	—	A	A	A	B	A	B	None	Fast	37,000	Yes
Electrical Cleaner & Lubricating Spray 37499	—	X	X	X	X	—	A	A	B	B	B	B	None	Fast	36,700	Yes
Environmental Cleaner/Degreaser 37501	—	X	X	X	X	X	B	A	A	B	A	B	-20	Very Fast	N/A	No
Electric Motor Degreaser/Safety Solvent 37502	—	—	X	X	X	—	A	A	A	B	A	A	None	Fast	39,500	No

A = Strong Cleaning Action

B = Good Cleaning Action

C = Moderate Cleaning Action

Is maximum solvency your main concern?	Yes, and I don't want to leave a residue film.	F.F. Safety Solvent/Degreaser 37498
	Yes, and I want a lubricating film.	Electrical Cleaner and Lube Spray 37499
Do you require a non-chlorinated product?	Yes, even if it has lower solvency and a lower flash point.	Environmental Cleaner/Degreaser 37501
Is very fast drying time your main concern?	Yes, and I want no CFC's.	Environmental Cleaner/Degreaser 37501
Is High Dielectric Strength your main concern?	Yes, and I want a good all-purpose cleaner.	F.F. Safety Solvent/Degreaser 37498
	Yes, and I need an economical product.	Electric Motor Degreaser/Safety Solvent 37502
Are you cleaning heavy residue from electric motors?	Yes, and I'm not working around plastics.	Electric Motor Degreaser/Safety Solvent 37502

SPRAYON® CONTACT CLEANERS

Description	MSDS Ref #	Part #	Can Size	Net Fill	Std Pk
Electro Wizard™ Electronic Contact Cleaner	S02206000	37680 ★	16 oz	10 oz	12
Plastics Contact Cleaner	S02020	37504 ★	16 oz	12 oz	12
Electronic Contact Cleaner	S02302	37506 ★	16 oz	11 oz	12
Flash Free Safety Solvent and Degreaser*	S20848	37498 ★	20 oz	17 oz	12

*Features High Delivery Nozzle.

★ Made in USA

Sprayon® Electro Wizard™ Electronic Contact Cleaner

37680

A new patent pending formula that instantly removes, dissolves and rinses away foreign contaminants from sensitive equipment and precision instruments. Instant evaporation eliminates trapping of airborne contaminants and allows parts to be handled immediately. Safe on most plastics. D.S. of 12.5 volts. K2 rated, NSF registered.

Sprayon® Plastics Contact Cleaner

37504

Versatile cleaning and degreasing agent that quickly removes light contaminants with no residue and no temperature control problems. Can be applied while equipment is operating because of instant evaporation. Safe on most plastics. D.S. of 19.0 volts. K2 rated, NSF registered.

Sprayon® Electronic Contact Cleaner

37506

Heavy-duty degreaser and quick-drying cleaner. Ideal for sensitive equipment and precision instruments. Fast-evaporating and leaves no residue. For use on non-energized equipment. Safe on most plastics. K2 rated, NSF registered.

Sprayon® Flash Free Safety Solvent

37498

Fast-acting solvent penetrates easily, evaporates quickly and leaves no residue. Excellent cleaning properties make it ideal for removing grease, dirt, wax and metallic particles prevalent in most industrial plants. Non-conductive and non-flammable. Includes extension tube and high delivery nozzle for flush-type applications. D.S. of 37.0 volts. K2 rated, NSF registered.

Uses:

Removes oil, grease, dirt and other contaminants from sensitive equipment, electrical contacts and precision instruments.



You can find access to all current MSDS sheets on the Krylon Products Group website.

www.KPG-Industrial.com

SPRAYON® ELECTRICAL & ELECTRONIC CLEANERS & DEGREASERS

Description	MSDS Ref #	Part #	Can Size	Net Fill	Std Pk
Flash Free Safety Solvent & Degreaser*	S00848	37497	16 oz	13 oz	12
Flash Free Safety Solvent & Degreaser†	S20848	37498 ★	20 oz	17 oz	12
Electrical Cleaner & Lubricating Spray	S02001	37499	16 oz	16 oz	12
Environmental Cleaner Degreaser	S00749	37501 ★	20 oz	15 oz	12
Electric Motor Degreaser/Safety Solvent	S00703	37502	20 oz	19.25 oz	12
Non-Chlorinated Electrical Degreaser	S02084600	37651	20 oz	18 oz	12

*Features Fine Mist Sprayer.

★ Made in USA

†Features High Flow Valve.

Sprayon® Flash Free Safety Solvent

37497/37498

Fast-acting solvent penetrates easily, evaporates quickly and leaves no residue. Excellent cleaning properties make it ideal for removing grease, dirt, wax and metallic particles prevalent in most industrial plants. Non-conductive and non-flammable. D.S. of 37,000 volts. K2 rated, NSF registered.

Sprayon® Electrical Cleaner & Lubricating Spray

37499

Makes high-precision electrical equipment perform like new. Cleans and penetrates surface pores and leaves a fine microscopic corrosion-proof film. Instant cleaning action cuts cost per application. D.S. of 36,700 volts. K2 rated, NSF registered.

Sprayon® Environmental Cleaner/Degreaser

37501

Designed for fast, effective removal of dirt, oil, grease, wax and tar on electrical equipment. For use on non-energized equipment. Leaves no residue — fast evaporating. K2 rated, NSF registered.

Sprayon® Electric Motor Degreaser

37502

A chlorinated solvent that penetrates quickly to easily lift dirt, grease and tars. Ideal for electrical equipment. Requires no washing or flushing—simply spray on and wipe off. Will not harm insulators or leave a residue. K2 rated, NSF registered.

Uses:

Removes grease, dirt, dust and oxidation residue from electric motors, gears, cables, generators, molds, chains and fuse holders. Some products also apply a corrosion proof film.



You can find access to all current MSDS sheets on the Krylon Products Group website.

www.KPG-Industrial.com

Sprayon® Non-Chlorinated Electrical Degreaser

37651

A non-chlorinated, non-flammable, fast-evaporating cleaner penetrates instantly to remove dirt, oil, grease and wax. Increases the life of electrical components by removing foreign materials that can cause costly downtime. Degreases more thoroughly and several times faster than alkaline cleaners. Excellent for degreasing aluminum, cleaning sheet and strip steel prior to galvanizing. D.S. of 15.0 volts. K2 rated, NSF registered.

SPRAYON® LUBRICANTS • SPECIALTY AND GENERAL PURPOSE

Description	MSDS Ref #	Part #	Can Size	Net Fill	Std Pk
711® Protector™ Lubricant (Aerosol)	S00711	37508 ★	16 oz	11 oz	12
Rust Breaker™ Penetrant	S00103	37509 ★	16 oz	12 oz	12
Premium Silicone Lube (6.6%)	S01324	37510 ★	16 oz	10 oz	12
H. D. Open Gear/Wire Rope Lube	S00201	37511 ★	16 oz	12 oz	12
Cutting Oil	S00208	37513 ★	16 oz	12 oz	12

★ Made in USA

Uses:

Reduces friction and stops squeaks and sticking by displacing moisture and repelling water from lugs, bolts, gears, cables, roller chains, machine tools, connectors, linkages and production equipment of all kinds.



Sprayon® Heavy Duty Open Gear/Wire Rope Lube

37511

Penetrates to core of wire rope, minimizing internal friction. “Travels” on metal surfaces, displacing water to provide excellent rust protection. Withstands extreme pressure with maximum adhesive and works from 0° to 250°F. Penetrates pores of surfaces without heating. H2 rated, NSF registered.

Sprayon® 711® Protector™ Lubricant

37508

Excellent choice to penetrate, lubricate, demoiseurize and inhibit corrosion. Ultra-thin, greaseless formulation. Does not attract contaminants. Safe on plastic surfaces. H2 rated, NSF registered. High D.S. 47,000 volts.

Sprayon® Rust Breaker™ Penetrant

37509

Transparent, non-staining oil loosens rust and releases frozen lugs, bolts and tight fitting parts. H2 rated, NSF registered. Won't harm painted surfaces. D.S. of 33,000 volts.

Sprayon® Premium Silicone Lube

37510

6.6% silicone formula stops squeaks and sticking, eliminates friction, repels water and prevents freezing. Does not harden or degrade from -40° to 400°F. Apply to wood, metal, fabric, rubber or leather. Keeps rubber soft and flexible.

Sprayon® Cutting Oil

37513

Extends tool life, reducing tool sharpening and downtime. Recommended for all metals, including stainless steel and soft metals such as aluminum, brass and copper. Clings to surface. Jet-spray allows precision applications. H2 rated, NSF registered.

You can find access to all current MSDS sheets on the Krylon Products Group website.

www.KPG-Industrial.com

SPRAYON® & KRYLON® INDUSTRIAL • CORROSION INHIBITORS & INSULATING VARNISHES

- Protects metal surfaces from the damaging effects of corrosive environments.

Description	MSDS Ref #	Part #	Can Size	Net Fill	Std Pk
Zinc Rich Cold Galvanizing Compound (Aerosol)	S00740	37518 ★	16 oz	14 oz	12
Clear Insulating Varnish	S00600	37520 ★	16 oz	14 oz	12
Red Insulating Varnish	S00601	37521 ★	20 oz	15.25 oz	12
Long Term Indoor Protectant and Lube	S00767	37528 ★	16 oz	11 oz	12
Red Oxide Rust Control Primer	S00339	37529 ★	16 oz	12 oz	12

★ Made in USA

Sprayon® Zinc Rich Cold Galvanizing Compound

37518

Fast-drying, high-solids, high-performance epoxy based coating. Provides maximum protection to steel exposed to severe corrosive environments. Fuses zinc to the metal substrates to protect against corrosion. Equal to or better than hot-dipped galvanizing. 97% pure zinc dust.

Sprayon® Insulating Varnish

37520/37521

Thoroughly penetrates old and new materials. Air-dries faster than most insulating aerosols. Provides high adhesion, high arc resistance and non-tracking properties. Resists abrasion and wear. D.S. up to 2,200 volts.

Sprayon® Long Term Indoor Protectant and Lube

37528

Penetrates thoroughly and forms a tough, flexible film. High arc resistance and non-tracking properties. Resists oil, water, acids and alkalis. Excellent adhesion.

Krylon® Industrial Tough Coat® Red Oxide Rust Control Primer

37529

Specially formulated for a variety of industrial applications. Ideal for light to heavy duty painting projects, both indoors and outdoors. Smooth, even coverage. Fast drying—dries to the touch in just 15 minutes.



You can find access to all current MSDS sheets on the Krylon Products Group website.

www.KPG-Industrial.com

SPRAYON® GENERAL PURPOSE & GLASS CLEANERS



Uses:

Removes grimy dirt, grease and oil from a wide variety of industrial surfaces.

Description	MSDS Ref #	Part #	Can Size	Net Fill	Std Pk
General Purpose Cleaner	S00880	37524 ★	20 oz	19 oz	12
Heavy Duty Glass Cleaner	S00888	37525 ★	20 oz	18 oz	12
Neutra-Force® Heavy Duty Foaming Degreaser	S1201S1219	37495 ★	20 oz	19 oz	12

★ Made in USA

Sprayon® General Purpose Cleaner

37524

All-purpose formula that cuts through dirt with ease. Effective and safe to use on metal, finished wood, porcelain, vinyl, leather, laminated surfaces and glass. Cleans spots on synthetic carpets. C1 rated, NSF registered.

Sprayon® Heavy Duty Glass Cleaner

37525

Removes soil, smoke haze, finger prints, road film and surface smears. Cleans any surface not normally harmed by water. Will not cloud plastic materials. Resists streaking—wipes clean. C1 rated, NSF registered.

Sprayon® Neutra-Force® Heavy Duty Foaming Degreaser

37495

A degreaser that delivers fast and effective cleaning on a variety of industrial soils. It contains no caustics, alkali, phosphates, or silicates. Powerful foaming action clings to surface and effectively breaks-down contaminants for effortless removal. Contains no fragrance or dyes and is acceptable as an A1 rated cleaner in food processing facilities.

You can find access to all current MSDS sheets on the Krylon Products Group website.

www.KPG-Industrial.com

PAINT & CHEMICALS

SPRAYON® INSECTICIDES & INSECT REPELLENTS • INDUSTRIAL GRADE

Description	MSDS Ref #	Part #	Can Size	Net Fill	Std Pk
Blast 'Em Wasp & Hornet Spray	S00857	37522 ★	16 oz	12 oz	12
Blast 'Em Wasp & Hornet Spray	S02085700	37725 ★	20 oz	14 oz	12
Insect Repellent II	S00856	37523 ★	8 oz	6 oz	12

★ Made in USA

Sprayon® Blast'Em Wasp & Hornet Spray

37522 & 37725

Contains a high amount of petroleum distillates for the best knockdown and kill rate. Residual deposit will kill returning wasps and hornets. Will not harm most plastics. 98% knockdown, 100% kill within 24 hours. D.S. of 33,000 volts. Sprays up to 20 feet. EPA registered.

Sprayon® Insect Repellent II

37523

Effectively repels mosquitoes, chiggers, ticks, deer flies, stable flies, black flies, gnats and fleas. Protects against Lyme disease. Can be applied to skin, clothing and anywhere that insects are a problem. Does not contain R-11. EPA registered.



Uses:
Jobsite protection.

You can find access to all current MSDS sheets on the Krylon Products Group website.
www.KPG-Industrial.com

LUMBER CRAYONS

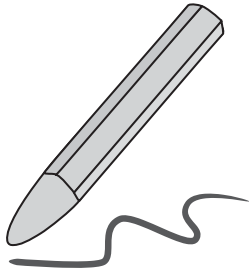

- Use to mark on a variety of surfaces – including metal, wood and plastic.
- Resists smearing and fading from exposure to water and sun.

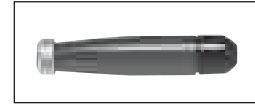

67410

Color	Part #	Unit	Std Pk
Red	67400 ★	12	144
Yellow	67402 ★	12	144
Blue	67404 ★	12	144
Black	67405 ★	12	144
Lumber Crayon Holder	67410 ★	12	12

★ Made in USA

DURA-INK® 15 BLACK MARKER.



This fine bullet tip marker produces accurate and easily readable, thin marks, making it ideal for everything from the shop floor to the shipping room, and parts identification to layout work.

- Black ink contain low halogens.
- Extra tough tip won't spread or mush.
- Smear-resistant, water-resistant, fast-drying.

Applications

- Marks on metal, wood, cardboard, paper, plastic, glass, etc.
- For identification of parts, layout work, and marking cartons and crates.
- Fine point for fine line marking.

Description	Part #	Std Pk
Dura-Ink® 15 Black Marker with Fine Bullet Tip	10030	1*

*48 Piece Canister

I, I, I Trichloroethane 224

Also called I, I, I trichlor. A chlorinated solvent now banned by the EPA. Sometimes confused with Trichloro-ETHYLENE, a permitted solvent.

Chlorinated Solvents (CFCs & HCFCs)

Common ozone-depleting solvents gradually being phased out by the EPA.

Date Code

Date of production, indicated by a 4-digit code on the bottom of the can. The first 3 digits indicated the numerical day of the year, the 4th digit indicates the year, For example 1818=181st day of 1998 (June 30, 1998). Most paints and chemicals have a shelf life of 3 years from date of manufacture.

Dielectric Strength

A measurement of how well a spray conducts electricity (in Kilovolts per millimeter). A high dielectric strength indicates that a spray is not a good conductor of electricity (which makes it a relatively safe choice for use around electrified equipment). Most low conductivity cleaners will have dielectric strengths ranging from 15,000 to 47,000 (safest).

Flammability

Flammability is rated on a 0 to 4 scale, with 0 being the safest and 4 being the most flammable. This information is printed on each MSDS sheet. When selecting a cleaner for degreaser, the first thing you may want to determine is whether the application requires a non-flammable product.

Flash Point

Lowest temperature at which vapors from an aerosol formula will ignite in air when exposed to a flame. When you see a product with a flash point of -20°F this means the most flammable component in the aerosol can ignite at -20°F. The actual aerosol spray, a mixture of a number of chemicals, will generally remain stable to a much higher temperature.

MSDS

These sheets list the individual ingredients contained in each product and identify the potential health, fire, explosion and reactivity risks. They also provide a list of precautions and remedies for most common problem situations. A number of government agencies require that these be supplied upon request. You can find access to all current MSDS sheets on the Krylon Products Group website, www.KPG-Industrial.com.

Net Weight

The amount of material that is evacuated or sprayed from the can. It is common in the chemical industry to promote full can weight (which includes propellant). When comparing Krylon Products Group products with those of other manufacturers, be sure to compare actual net weights.

Ozone Depleters

None of our products are class I ozone depleters (the most restricted). Only two are classified II depleters: Safety Cleaner and Degreaser II and Contact Tuner and Cleaner.

Plastic Safe

Some cleaners and degreasers work so well that they dissolve some plastic insulating materials. Plastic safe cleaners, on the other hand, are gentle enough to be applied directly to plastic surfaces.

Residue

This term has two meanings. Some aerosol sprays are designed to leave a fine lubricating film on the machine surface. In common vernacular, *residue* also refers to the sticky film left by a poor-performing product.

Solvency (KB Value)

A measure of how well an electronic cleaner dissolves impurities. The higher the number, the stronger the cleaner; the lower the number, the weaker the cleaning effect. It's important to keep in mind that "weaker" is not necessarily a bad thing. It just means the product is designed to be a more gentle cleaning agent.

Technical Support

If you have a specific application question or are looking for a Krylon Products Group cross-reference to a competitor's product, please call Krylon Products Group technical support 800-251-2486.

NSF Registration

Following the 1998 termination of the USDA authorization and listings program for propriety substances and non-food compounds, NSF International was requested to continue the program with advice from USDA. Certain lubricants and cleaners are registered by NSF for use in food manufacturing.

VOC (Volatile Organic Compounds)

These materials are a major contributor to urban smog and some regions have created laws to limit their use, especially in California and the OTC states in the northeastern U.S.

WHITE LIGHTNING® SILICONE SEALANT

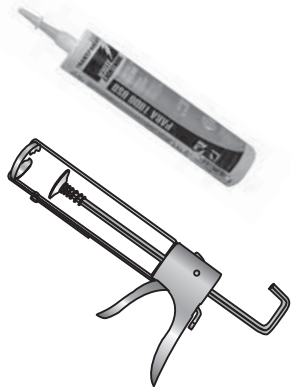

- Provides a watertight seal.
- Use for interior and exterior projects.
- Highly, permanently flexible.
- Will not crack, crumble or shrink.
- Resists moisture and mildew.
- Excellent adhesion to non-porous materials.
- Not paintable.
- NSF compliant.
- Complies with TT-S-00230C, TTS-001543A, ASTM C-920.

Description	MSDS Ref #	Part #	Can Size	Std Pk
100% RTV Silicone Sealant – Clear	WL9010	37530 ★	10 oz	12
100% RTV Silicone Sealant – White	WL9210	37531 ★	10 oz	12
EZ-Thrust Caulk Gun	—	96000 ★	—	1

★ Made in USA

SPRAYON® CLEAR SILICONE



- Chemically stable.
- Shows little change in physical properties after exposure to sunlight, rain, snow, ozone, temperature extremes and weathering.
- Mildew resistant.
- Long tooling time of 5–10 minutes.
- P1 rated, NSF registered.

Description	Part #	Net Fill	Std Pk
RTV Clear Silicone Sealant	96070 ★	7.25 oz	12

★ Made in USA

TRI-FLOW® LUBRICANTS WITH P.T.F.E.



- Lubricates with oils, additives and P.T.F.E. to reduce friction and increase part life.
- Penetrates inaccessible areas to displace contaminants.
- Rejects dirt, dust, and other abrasive particles.
- Effective from -60° to 475°F.
- H2 rated, NSF registered.
- Offers 10 times as much load capacity as WD-40 in a standard Falex-Load Text (ASTM D-3233b).

Uses:

- Machinery
- Conveyors
- Bearings
- Cables
- Gears

Description	Container	MSDS Ref #	Part #	Can Size	Net Fill
Industrial Lubricant	Aerosol Can	TF20025	37514 ★	12 oz	6 oz
Industrial Lubricant	Trigger Spray Bottle	TF29200	37515 ★	6 oz	18 oz
Industrial Lubricant	Non-Aerosol	TF21010	37516 ★	12 oz	2 oz

★ Made in USA

WHITE LIGHTNING® STOP GAP!™ • EXPANDING FOAM

- Dries tack free in less than 30 minutes.
- Cures in 8 hours.
- Cured product can be trimmed, shaped, sanded, painted or stained.
- Can be applied at temperatures between 60°F and 100°F.
- Great for use on corner and T-joints, exterior sheeting, openings and gaps at the plate line, masonry and concrete or wood walls.



Description	MSDS Ref #	Part #	Can Size	Net Fill	Std Pk
Triple Expanding Insulating Foam	WL3333300	96060 ★	16 oz	12 oz	8

★ Made in USA

WET PATCH ROOF CEMENT

- Asbestos free.
- Meets ASTM D4586, ASTM D2822 and Fed Spec SS-C-153C, Type 1.
- Black fibered asphalt mastic works to seal and stop leaks.
- Easy to spread with a small mason's trowel, putty knife or caulking gun.
- Apply at a thickness of ¼" to form a tight weatherproof seal – even sticks in the rain!

Size	MSDS Ref #	Part #	Unit	Std Pk
10.3 oz Tube	RC016	96010 ★	1	24
1 Gallon	RC016	96030 ★	1	4

★ Made in USA



E-6000® INDUSTRIAL ADHESIVE • ABRASION RESISTANT SEALANT

- Maintains its adhesion sealant properties even when submerged under water.
- Paintable with water or oil based paints.
- Exceptionally flexible-can stretch to 600% of its length.
- Cures in 8 hours as sealant; 24 hours as an adhesive at 70°.
- 5 year shelf life (unopened).

Uses:

- Sealing circuit boards.
- Sealing junction boxes.
- Insulating electrical connections.
- Re-coating insulating wiring and cables.
- Exceptional adhesion to metal, wood, concrete, glass, masonry, fiber glass and ceramics.
- Adheres to many plastics, leather, rubber and vinyl.



Description	Color	Part #	Tube Size	Box Qty
E-6000® Squeeze Tube	Clear	96040 ★	3.7 oz	12
E-6000® Caulk Tube	Clear	96050 ★	10.2 oz	12
UV-6800 Square Tube	Clear	96140* ★	3.7 oz	12
UV-6800 Caulk Tube	Clear	96150* ★	10.2 oz	12

*UV-6800 works the same as E-6000® but offers special resistance when full sunlight exposure is a concern.

★ Made in USA

DARK CUTTING OIL • FOR CUTTING FERROUS MATERIALS



- Developed for smooth, easy cutting of ferrous materials and ferrous alloys.
- Pleasant to work with. Easy to see with a mild odor.
- May stain non-ferrous materials.

Application	MSDA Ref #	Part #	Size	Case Qty
For Cutting Ferrous Materials	TCO 14	96035 ★	Gallon	4

★ Made in USA

DUCT SEAL COMPOUND • EASILY MOLDED • SEALS INSTANTLY



- Seals around conduit openings and junction boxes.
- Adheres to most clean surfaces (for indoor applications).
- Paintable and will not harden.
- Non-conducting, non-toxic, non-corrosive and non-staining.
- UL Listed.
- 1 year shelf life.
- Contact customer service for pallet quantities.

Size	Part #	Unit	Case Qty
1# Plug	14300 ★	1	50
5# Plug	14305 ★	1	10

★ Made in USA

PAINT & CHEMICALS

ALL PURPOSE RAGS • INDUSTRIAL WIPING CLOTHS

Description	Part #	Qty
New Bleached Knits	37580	1 lb Bag of Rags
New Bleached Knits	37582	5 lb Bag of Rags
New Bleached Knits	37584	25 lb Box of Rags
New Bleached Knits	37586	50 lb Box of Rags
Recycled White T-Shirts	37587	25 lb Box of Rags
Recycled White T-Shirts	37588	50 lb Box of Rags
Recycled Colored T-Shirts	37590	25 lb Box of Rags
Recycled Colored T-Shirts	37591	50 lb Box of Rags



SCRUBS-IN-A-BUCKET®

- Citrus-based formula works fast to loosen, dissolve and absorb dirt, grease and grime.
- Perforated high-strength absorbent cleaning towels leave no residue.
- Can be used anywhere on the toughest soils, greases, tar and even ink.
- Safe for use on painted surfaces, composites, tools, equipment, plastics, vinyl and hands.



Safely Removes:

- | | | | | |
|------------|------------|--------------|------------|-------------|
| • Dirt | • Adhesive | • Tar | • Epoxy | • Paint |
| • Sealants | • Oils | • Lubricants | • Urethane | • Ink & Dye |
| • Grease | • Caulk | | | |

Description	Part #	Wipes/Bucket	Std Pk
Scrubs-in-a-Bucket®	37440 ★	72	6

★ Made in USA



FIRESTOP PUTTY PAD



- One pad thickness (1/8") provides a 1 to 2 hour fire rating.
- Meets ASTM E814, UL1479 and ULC/CAN4-S115-M.
- Covers two gang boxes.

Description	Size-	MSDS REF #	Part #	Case Qty
Firestop Putty Pad	6" x 7" x 1/8" Thick	0216	96230 ★	20

★ Made in USA

LECTRA-STOP™



- One step, one component system.
- Expands to seal openings when exposed to fire.
- Sound rated 55 STC.ASTM E84, UL 723 Tunnel Test. Two hour rating.
- Applies to back of box.
- Intumescent.

Description	MSDS REF #	Part #	Case Qty
Lectra-Stop™ Single Gang	0480	96234 ★	50
Lectra-Stop™ Double Gang	0480	96236 ★	50

★ Made in USA

FIRESTOP GASKETS



- One step, one component system.
- Expands to seal opening when exposed to fire.
- UL 723 tunnel test. 1 to 2 hour rating.
- Applies between receptacle and cover.
- Intumescent.

Visit www.biofireshield.com for detailed information on fire stopping products.

Description	MSDS REF #	Part #	Case Qty
Firestop Gasket Single Receptacle	0591	96238 ★	50
Firestop Gasket Double Receptacle	0591	96240 ★	50
Firestop Gasket Single Switch	0591	96242 ★	50
Firestop Gasket Double Switch	0591	96244 ★	50

★ Made in USA

Intumescent

Firestop products referred to as "intumescent" expand at high temperatures to fill gaps and contain fire and smoke.

FIRESTOP PUTTY STICKS

- Seals around electrical cables, conduit and metal pipes.
- ASTM E814, UL1479 and ULC/CAN4-S115M.
- Two hour rating.



Description	MSDS REF #	Part #	Case Qty
Firestop Putty Sticks	0216	96232 ★	12

★ Made in USA

FIRESTOP CAULK

- Intumescent

Description	Rating Size	Case Hours	MSDS REF #	Part #	Case Qty
Firestop Caulk 150+	10.3 oz	1-2	0582	96062 ★	24
Firestop Caulk 150+ (Sausage Pack)	20.2 oz		0582	96064 ★	12
Firestop Caulk 150+	5 Gal		0582	96066 ★	1
Firestop Caulk 500+	10.3 oz	4	0200	96055 ★	24
Firestop Caulk 500+ (Sausage Pack)	20.2 oz		0200	96058 ★	12
Firestop Caulk 500+	5 Gal		0200	96059 ★	1
Caulking Gun for Sausage Pack			—	96002	1



★ Made in USA



FIRESTOP PILLOWS

- Designed for large openings with cables, cable trays, blank openings or multiple penetrating items.
- Three hour rating.
- Most economical firestop pillows available.
- Intumescent.

Size	Part #	Case Qty
2" x 9" x 6"	96246 ★	10
3" x 9" x 6"	96248 ★	10

★ Made in USA



Size	Blade	Handle	Grip	Weight (lbs)	Part #
Size 2 Round Point Shovel	Hollow Back 8 ⁷ / ₈ " x 11 ³ / ₄ "	47" Fiberglass	Double-Dip	5.00	37250
Size 2 Round Point Shovel	Hollow Back 8 ⁷ / ₈ " x 11 ³ / ₄ "	27" Fiberglass	D-Grip	4.50	37251
Size 2 Square Point Shovel	Hollow Back 8 ⁵ / ₈ " x 11 ¹ / ₄ "	47" Fiberglass	Double-Dip	4.75	37253
Size 2 Mud Round Point Shovel	Hollow Back 8 ³ / ₄ " x 11 ¹ / ₂ "	47" Fiberglass	Double-Dip	4.95	37160
Size 2 Mud Square Point Shovel	Hollow Back 8 ³ / ₄ " x 11 ¹ / ₄ "	47" Fiberglass	Double-Dip	4.95	37161
4" Classic Trench Shovel	Hollow Back 4" x 12"	489 Fiberglass	Double-Dip	3.50	37262
4" Step Trench Shovel	Steel, Forward Step 4" x 11"	47" Fiberglass	Double-Dip	4.00	37163
3" Step Trench Shovel	Steel, Forward Step 3" x 11"	47" Fiberglass	Double-Dip	4.00	37164
5" Step Trench Shovel	Steel, Forward Step 5" x 11"	47" Fiberglass	Double-Dip	4.75	37165
4" Trench Clean-Out Shovel	Steel 4" x 10"	60" Fiberglass	Vinyl	3.75	37267
Forged Head 16 Tine Bow Rake	16 ³ / ₄ " x 3" Curved Steel Tines	60" Fiberglass	Double-Dip	4.00	37166
Forged Level Head Rock Rake	16 ³ / ₄ " x 3" Straight Steel Tines	66" Fiberglass	Double-Dip	4.25	37167
Small-Head Irrigating/Floral	Hollow Back 6" x 8 ¹ / ₂ "	46" Fiberglass	Vinyl	2.75	37256
Small-Head Irrigating/Floral	Hollow Back 6" x 8 ¹ / ₂ "	22" Fiberglass	D-Grip	2.00	37257
Small-Head Irrigating/Floral	Hollow Back 6" x 8 ¹ / ₂ "	31" Fiberglass	Vinyl	2.50	37263
14" Drain Spade/Sharp Shooter	Hollow Back 5 ³ / ₄ " x 14"	48" Fiberglass	Double-Dip	5.00	37259
14" Drain Spade/Sharp Shooter	Hollow Back 5 ³ / ₄ " x 14"	30" Fiberglass	D-Grip	4.25	37162
Sledge Hammer	8 lb. Double-Faced Head	36" Fiberglass	None	10.00	37275
Sledge Hammer	10 lb. Double-Faced Head	36" Fiberglass	None	12.00	37277
Sledge Hammer	12 lb. Double-Faced Head	36" Fiberglass	None	14.00	37279
Pick Mattock	5 lbs. Head w/#6 Eye	36" Fiberglass	None	7.50	37273
48" Utility Probe	3/4" Steel Tip on 1/2" Fiberglass Rod	8 ¹ / ₄ " Fiberglass	Vinyl	1.50	37265
Post Hole Digger	Head 9 ¹ / ₂ " x 6 ¹ / ₂ " w/6 ¹ / ₄ " Spread	48" Fiberglass	Double-Dip	10.00	37269
All Purpose Bar w/Tamper	Forged Wedge 2" x 9"	1" x 48" Steel Pipe	2 ¹ / ₂ " Taper	7.50	37271

Our Handle on Quality



Hollow fiberglass handles may be fine for recreational use but if you must rely on your hand tools everyday, Cully's fiberglass handles have a legacy of premium performance. All Cully handles are produced from thousands of continuous strands of fiberglass saturated with thermosetting resins and non-fiberglass polyester veil impregnated on the surface. The veil gives the handle a smooth finish and keeps the fiberglass from splintering.

Benefits of Fiberglass

- Greater strength pound for point than steel.
- Will not transmit heat or cold, and will not conduct electricity.
- Will not absorb moisture or warp.
- Is non-corrosive and resistant to acids and other chemicals.
- Is highly resistant to temperature changes.
- Resists impact, is non-denting and difficult to damage.
- Minimizes handle breakage and saves on-the-job downtime.

1. Our signature fiberglass handle used on our digging tools feature a thick wall fiberglass tube, which is less flexible than poly-molded handles, and has a solid fiberglass inner core in the base followed by a hardwood core through the remaining portion of the handle. The solid fiberglass core extends the stress point above the critical neck or collar portion of the handle which increases its overall strength and durability.



2. All of our long handle digging tools feature our new 8-inch Tuffoam double-dip grips which have been designed for the toughest industrial applications. The grips feature a durable, vinyl inner liner and a comfortable, non-slip foam exterior that provides long life and helps prevent potential harmful hand fatigue.
3. On tools that require less strength, such as rakes, we use a fiberglass handle with a honeycomb plastic core.
4. Our D-Grips, used on short and midlength handled tools, are made of one-piece high-density nylon.

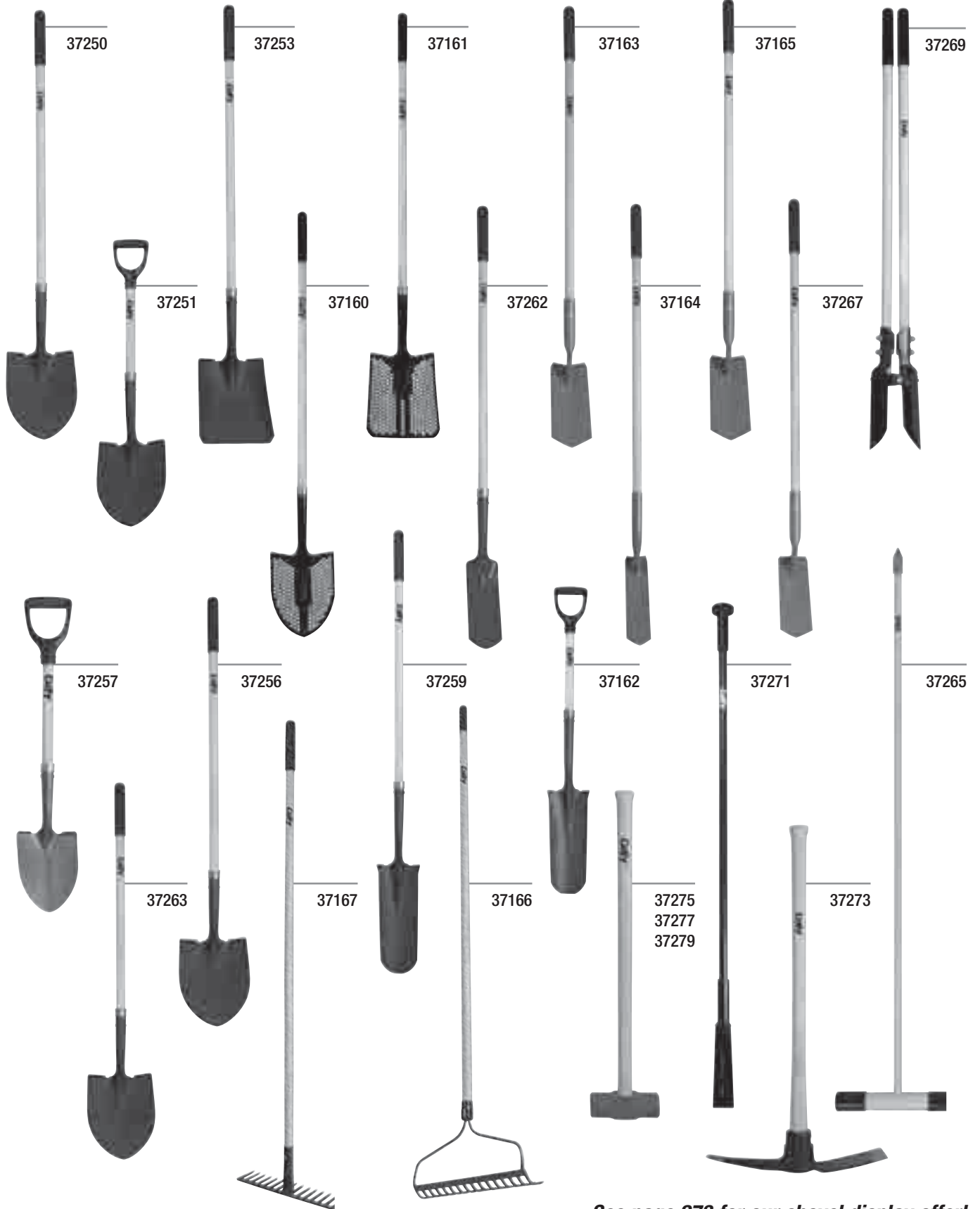

TOOLS

See page 273 for our shovel display offer!

ELECTRICIAN COMFORT COMBOS



Metal Buckle



Quick Release Buckle

Description	Buckle	Size	Color	MFG #	Part #
Ultimate Electrician Comfort Combo	Metal	Sm 28" – 32"	R. Blue	ULT104RYS	39340 ★
Ultimate Electrician Comfort Combo	Metal	Med 32" – 36"	R. Blue	ULT104RYM	39342 ★
Ultimate Electrician Comfort Combo	Metal	Lg 36" – 40"	R. Blue	ULT104RYL	39344 ★
Ultimate Electrician Comfort Combo	Metal	XL 40" – 44"	R. Blue	ULT104RYXL	39346 ★
Ultimate Electrician Comfort Combo	Metal	Lg 36" – 40"	Black	ULT104BKL	39343 ★
Electrician Comfort Combo	Metal	Med 32" – 36"	Black	104BKM	39370 ★
Electrician Comfort Combo	Metal	Lg 36" – 40"	Black	104BKL	39373 ★
Electrician Comfort Combo	Quick Release	Sm 28" – 32"	R. Blue	100RYS	39348 ★
Electrician Comfort Combo	Quick Release	Med 32" – 36"	R. Blue	100RYM	39350 ★
Electrician Comfort Combo	Quick Release	Lg 36" – 40"	R. Blue	100RYL	39352 ★
Electrician Comfort Combo	Quick Release	XL 40" – 44"	R. Blue	100RYXL	39354 ★

★ Made in USA

POUCHES & BAGS

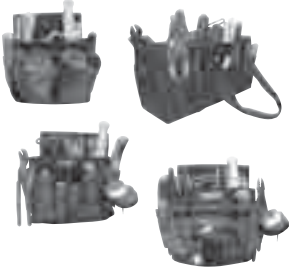

- The entire Boulder Bag line is available. Contact customer service for quantities and availability.

Description	Color	MFG #	Part #
Ultimate Connect-a-Pouch	Blue	Ult110RY	39336 ★
Ultimate Electrician Tool Pouch	Blue	Ult120RY	39338 ★
7 Pocket Pouch	Blue	110RY	39358 ★
Electrician Tool Pouch	Blue	120RY	39360 ★
Carry-All Bag		830	39368 ★

★ Made in USA

BELTS & SUSPENDERS



Description	Buckle	Size	Color	MFG #	Part #
Comfort Belt	Quick Release	Med 32" – 36"	Black	500M	39318 ★
Comfort Belt	Quick Release	Lg 36" – 40"	Black	500L	39320 ★
Comfort Belt	Quick Release	XL 40" – 44"	Black	500XL	39319 ★
Comfort Belt	Metal	Med 32" – 36"	Black	504M	39322 ★
Comfort Belt	Metal	Lg 36" – 40"	Black	504L	39324 ★
Comfort Belt	Metal	XL 40" – 44"	Black	504XL	39325 ★
Padded Suspenders			Black	527BK	39335 ★

★ Made in USA

ACCESSORIES



Description	Size	Color	MFG #	Part #
Small Meter Pouch	6"H x 2¾"W x 1½"D	Black	141BK	39314 ★
Drill Pouch	10"H x 6"W x 1½"D	Black	440BK	39316 ★
Hammer Holder	—	Black	530BK	39328 ★
Tape Clip	—	Black	545	39356 ★
Phone Case	4"H x 2"W x 1"D	Black	617	39364 ★

★ Made in USA

Electrician Comfort Combo

39348–39354

- Tape Clip (39356)
- 7 Pocket Pouch (39358)
- Hammer Holder (39328)
- Electrician Tool Pouch (39360)
- Comfort Belt with Quick Release Buckle (39318/39320)
- 11 Slots, 14 Pockets
- Quick Release Belt



Ultimate Electrician Comfort Combo

39340–39346

- Ultimate Connect-A-Pouch (39336)
- Hammer Holder (39328)
- Ultimate Electrician Tool Pouch (39338)
- Comfort Belt with Metal Buckle (39322/39324)
- 13 Slots, 19 Pockets
- Metal Buckle



Ultimate Connect-A-Pouch

39336

- Divided Main Compartment
- Large Divided Exterior Pocket
- Interior Pocket
- 2 Connect-A-Pouch Loops
- Upper Velcro Pocket with 4 Elastic Slots



Ultimate Electrician Tool Pouch

39338

- Main Compartment
- 3 Exterior Pockets
- 4 Exterior Slots
- Exterior Tape Pocket
- Interior Utility Knife Pocket
- 6 Interior Pockets
- 3 Interior Slots



7 Pocket Pouch

39358

- Main Compartment
- 2 Interior Pockets
- 2 Large Exterior Pockets
- 2 Exterior Side Pockets



Electrician Tool Pouch

39360

- Divided Main Compartment
- Interior Utility Knife Pocket
- 2 Exterior Pockets
- 6 Exterior Slots
- Interior Pencil Pocket
- Interior Large Pocket
- 5 Interior Slots
- Tape Chain
- Tool Clip

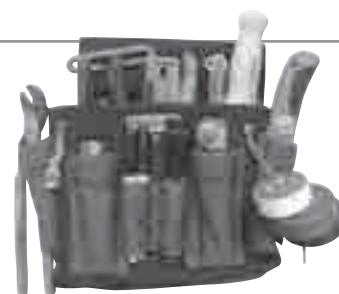

Carry-All-Bag

39368

- 20 Outside Pockets
- 14 Inside Pockets
- Semi-Rigid Construction

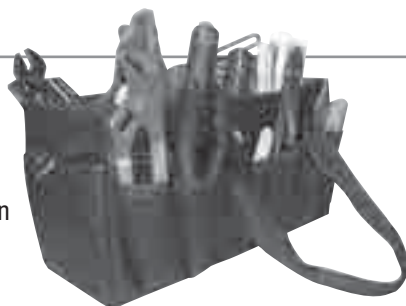

MEGAPRO+ 15-IN-1 SCREWDRIVER

Fully Loaded Driver

Description	Part #	Qty
Cully Blue	37200*	1

*Replaces part numbers: 37291, 37292, 37293, 37294, 37295.

Bit Load

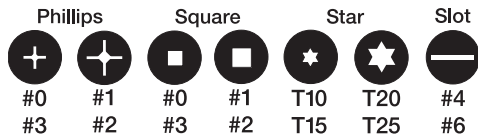

Replacement Bits

Description	Part #	Qty
T10-T15 Star Bit*	40021	1
T20-T25 Star Bit*	40022	1
#0 & #3 Phillips*	40003	1
#1 & #2 Phillips*	40004	1
#0 & #3 Square Drive*	40005	1
#1 & #2 Square Drive*	40006	1
#4 & #6 Slotted Drive*	40007	1
¼ Mag Nut Setter	40008	1
⅝ Mag Nut Setter	40009	1

*Driver comes packed with bits.

TOOLS



Seven double-ended bits give you the 14 most popular screwdriver tips!

MEGAPRO+ 15-IN-1 SCREWDRIVER • STAINLESS STEEL

- Nickel plated bits and stainless steel shaft for a maximum corrosion resistance.
- Great for marine applications, high humidity environments and outdoors.

Fully Loaded Driver

Description	Part #	Qty
Stainless Steel	37285	1

Replacement Bits

Description	Part #	Qty
T10-T15 Star Bit*	40021NP	1
T20-T25 Star Bit*	40022NP	1
#0 & #3 Phillips*	40003NP	1
#1 & #2 Phillips*	40004NP	1
#0 & #3 Square Drive*	40005NP	1
#1 & #2 Square Drive*	40006NP	1
#4 & #6 Slotted Drive*	40007NP	1

*Driver comes packed with bits.

MEGAPRO+ QUICK CHANGE SCREWDRIVER

Description	Part #	Qty
Orange Driver Fully Loaded	37150	1
#0 & #3 Square Drive*	40012	1
#1 & #2 Square Drive*	40013	1
#0 & #3 Phillips*	40014	1
#1 & #2 Phillips*	40015	1
#4 & #6 Slot*	40016	1
T10 & T15 Star*	40017	1
T20 & T25 Star*	40018	1
6" Driver Extension	40019	1
¼" Socket Adapter	40020	1
6-32 Hex Shank Power Tap**	68036 ★	1
8-32 Hex Shank Power Tap**	68038 ★	1
10-24 Hex Shank Power Tap**	68040 ★	1
10-32 Hex Shank Power Tap**	68044 ★	1
¼-20 Hex Shank Power Tap**	68046 ★	1
Hex Shank Power Tap Kit (6-32, 8-32, 10-24, 10-32, ¼-20)**	68096 ★	1

Bit Load						
Phillips		Square		Star		Slot
#0	#1	#0	#1	T10	T20	#4
#3	#2	#3	#2	T15	T25	#6

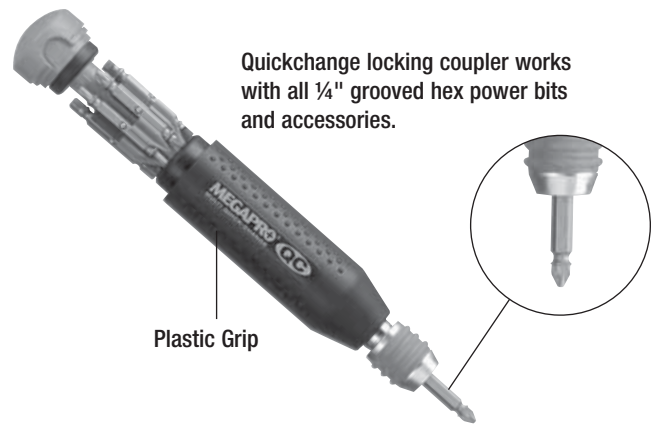

*Driver comes packed with bits.

**Hex Shank Taps are not warranted against breakage.

★ Made in USA

TOOLS

MEGAPRO+ 16-IN-1 SCREWDRIVER • TAMPERPROOF

- Professional grade double-ended ¼" bits. Hardened to a 59 Rockwell.
- Spring-loaded, ball bearing bit assembly grasps bit snugly every time.
- Solid steel shaft runs the full length of the driver for balance and strength.
- Palm saving rotating cap covers easy access bit compartment.

Fully Loaded Driver		
Description	Part #	Qty
Grey	37011	1

Replacement Bits		
Description*	Part #	Qty
T10H-T15H Star Pin	69001	1
T20H-T25H Star Pin	69002	1
T27H-T30H Star Pin	69003	1
⅛-⅝ Socket Pin	69004	1
⅝-⅞ Socket Pin	69005	1
#6 & #8 Spanner	69006	1
#10 & #12 Spanner	69007	1
#1 & #2 Square Drive	40006	1

Bit Load								
Spanner		Square	Socket Pin		Star			
#6	#10	#1	1/8	5/32	T10H	T20H	T27H	
#8	#12	#2	9/64	3/16	T15H	T25H	T30H	

Don't forget Tamperproof Screws. See pages 46-49 for a complete guide.

See page 138 for our 29-in-1 Tamperproof Driver Bit Kit.

*Driver comes packed with bits.



6-IN-1 ECONOMY SCREWDRIVER • QUICK CHANGE



- Quick change bit system with double-ended shaft and bits.
- Ends of shaft serve as two hex drivers.
- Ergonomic handle is comfortable and provides a good gripping surface.

Free Counter Display with 18 Unit Minimum Purchase!

Bit Load	Color	Part #	Box Qty
Phillips: #1, #2 Slotted: ¼", ⅜" Hex: ¼", ⅝"	Orange	37014	18
Phillips: #2 Slotted: ¼" Hex: ¼", ⅝" Square Drive: #1, #2	Red	37016	18

TOOLS

13-IN-1 RATCHETING SCREWDRIVER



- Cushion grip
- Retractable bit cartridge
- Palm saver cap

Bit Load	Color	Part #	Qty
Phillips: #0, #1, #2, #3 Slotted: #4, #6 Square Drive: #1, #2 TORX: #10, #15, #20, #25	Red and Black	37020	1

14-IN-1 HVAC SCREWDRIVER



- Plastic grip
- Alloy Steel Shaft
- Palm saver cap
- Easy guide collar
- Retractable bit cartridge

Bit Load	Color	Part #	Qty
Phillips: #0, #1, #2, #3 Slotted: #3, #4, #5, #5.5, #6 Square Awl: Valve Stem	Blue	37021	1

15-IN-1 TAMPERPROOF 2 SCREWDRIVER



- Plastic grip
- Alloy Steel Shaft
- Palm saver cap
- Easy guide collar
- Retractable bit cartridge

Bit Load	Color	Part #	Qty
Tri-Wing: #2, #3, #4, #5 TORX-Plus TR: #10, #15, #20, #25, #27, #30 TORX-Set: #4, #6, #8, #10	Red	37022	1

15-IN-1 SHAFTLOK 2 SCREWDRIVER

- Plastic grip
- Easy guide collar
- Palm saver cap
- Retractable bit cartridge

Bit Load	Color	Part #	Qty
Phillips: #0, #3 Slotted: #4, #6 Square Drive: #0, #1, #2, #3 TORX: #10, #15, #20, #25	Yellow	37023	1



SPANNER DRIVE & UN-DO-IT TOOL

Description	Size	Part #	Unit	Std Pk
Spanner (Snake Eyes) Screwdriver, Plastic Grip	#6	30006TP ★	1	10
Spanner (Snake Eyes) Screwdriver, Plastic Grip	#8	30008TP ★	1	10
Spanner (Snake Eyes) Screwdriver, Plastic Grip	#10	30010TP ★	1	10
Spanner (Snake Eyes) Screwdriver, Plastic Grip	#12	30012TP ★	1	10
Spanner (Snake Eyes) Screwdriver, Plastic Grip	#14	30014TP ★	1	10
One Way Un-Do-It Tool	#6-8	31206 ★	1	10
One Way Un-Do-It Tool	#10-12	31210 ★	1	10
One Way Un-Do-It Tool	#14	31214	1	10

★ Made in USA

See Tamperproof Screws
pages 46-49



TOOLS

SQUARE DRIVE SCREWDRIVERS

Description	Overall Length	Size	Screw Size	Color	Part #	Unit
Stubby, Plastic Grip	3"	#2	8, 9, 10	Red	30002	1
Stubby, Plastic Grip	3"	#3	12, 14	Black	30003	1
Midget, Plastic Grip	6½"	#0	3, 4	Yellow	31000	1
Rubber Cushion Grip, Short	7½"	#1	5, 6, 7	Green	35001	1
Rubber Cushion Grip, Short	7½"	#2	8, 9, 10	Red	35002	1
Rubber Cushion Grip, Short	7½"	#3	12, 14	Black	35003	1
Rubber Cushion Grip, Long	10"	#1	5, 6, 7	Green	34001	1
Rubber Cushion Grip, Long	10"	#2	8, 9, 10	Red	34002	1
Rubber Cushion Grip, Long	10"	#3	12, 14	Black	34003	1



TAMPERPROOF KIT • 29-IN-1 DRIVER KIT

- 29 piece assortment of security bits includes star pin, socket pin, tri-wing, torq-set bit, square drive and spanner bit.
- Features a magnetic hand driver with storage case.
- Includes a magnetic holder for power driving!

This is one of the most complete tamperproof screwdriver kits available anywhere with all of the most common and many of the rarest bits.

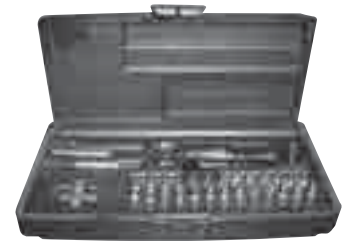

37009

Description	Size	Part #	Qty
29-In-1 Driver TamperProof Kit	—	37009	1
Socket Adapter	1"	92600 ★	1
Magnetic Bit Holder	3"	92602 ★	1

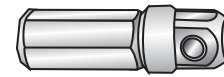



92600





92602

TOOLS

Spanner Bit 	
Size	Part #
#6	31106 ★
#8	31108 ★
#10	31110 ★

Star Pin 	
Size	Part #
T-8H	38983 ★
T-9H	38984 ★
T-10H	38985 ★
T-15H	38988 ★
T-20H	38990 ★
T-25H	38992 ★
T-27H	38994 ★
T-30H	38996 ★
T-40H	38998 ★

Tri-Wing 	
Size	Part #
#1	38705 ★

Pozi Drive 	
Size	Part #
#1	92500 ★

Socket Pin 	
Size	Part #
1/8"	92706 ★
9/64"	92707 ★
5/32"	92709 ★
3/16"	92710 ★
7/32"	92711 ★
1/4"	92718 ★
5/16"	92720 ★

★ Made in USA

**Don't forget
Tamperproof Screws.
See pages 46-49.
See page 135 for our 16-in-1
Tamperproof Screwdriver.**

DIAL-A-BIT KIT • SLOTTED, PHILLIPS & SQUARE DRIVE





- Includes a magnetic bit holder for power driving.

- Magnetic bit holder inserts into star hole at top of the bit case to become a screwdriver handle.

Description	Part #	Qty
10 Piece Kit	39917 ★	1

Description	Part #
¼" Magnetic Bit Holder	92602 ★

Slotted 	
Size	Part #
#6	38648
#8	38561 ★
#10	38661 ★

Phillips 	
Size	Part #
#1	38401
#2	38501
#3	38601 ★

Square 	
Size	Part #
#1	38101
#2	38201
#3	38301

★ Made in USA

DRIVER BIT ACCESSORIES



Description	Overall Length	Part #	Unit
Magnetic Bit Holder	¼" x 3"	39018	1



Description	Part #	Unit
Double Ended Power Bit: #2 Square Drive, #2 Phillips	38215	1
Double Ended Power Bit: Bucket O' Bits	38222	125



Description	Part #	Unit
Magnetizer/Demagnetizer	40010	1

QUICK CHANGE DRILL ADAPTER

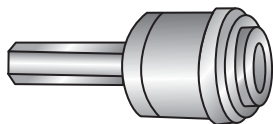

- Turns a standard drill into a keyless chuck for 2"+ longer power bits.

- Can also be used with hex shank drill bits (page 154).

Description	Part #	Unit
Quick Change Drill Adapter	39020 ★	1

★ Made in USA

SQUARE DRIVE HEX POWER BITS • 1/4" HEX SHANK

Size	Length	Screw Size	Plastic Bag		5 Pk Clamshell		Bucket O' Bits	
			Part #	Qty	Part #	Qty	Part #	Jar Qty
#0	1	#4	38001	1	—	—	—	—
	2		38002	1	—	—	—	—
	3		38003	1	—	—	—	—
#1	1	#5-6	38101	1	—	—	—	—
	2		38102	1	—	—	—	—
	3		38103	1	▲	—	—	—
	4		38104	1	▲	—	—	—
	6		38106	1	▲	—	—	—
	12		38112	1	▲	—	—	—
#2	1	#8-10	38201	1	38201-5	5	38200	250
	2		38202	1	38202-5	5	38220	125
	3		38203	1	38203-5	5	—	—
	4		38204	1	▲	—	—	—
	6		38206	1	▲	—	—	—
	10		38210	1	▲	—	—	—
	12		38212	1	▲	—	—	—
	12		38212	1	▲	—	—	—
#3	1	#12-14	38301	1	38301-5	5	—	—
	2		38302	1	38302-5	5	—	—
	3		38303	1	▲	—	—	—
	4		38304	1	▲	—	—	—
	6		38306	1	▲	—	—	—
	8		38308	1	▲	—	—	—

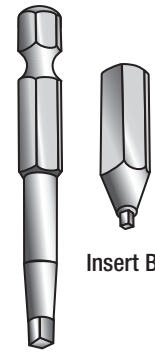

Hex Power Bit

Insert Bit

- All bits 1" length are insert bits. All bits over 1" length are sold as hex power bits.

TOOLS

PHILLIPS HEX POWER BITS • 1/4" HEX SHANK

Size	Length	Plastic Bag		5 Pk Clamshell		Bucket O' Bits	
		Part #	Qty	Part #	Qty	Part #	Jar Qty
#1	1	38401	1	▲	—	—	—
	2	38402	1	▲	—	—	—
	3	38403	1	▲	—	—	—
	4	38404	1	▲	—	—	—
	6	38406	1	▲	—	—	—
	12	38412	1	▲	—	—	—
#2	1	38501	1	38501-5	5	38500	250
	2	38502	1	38502-5	5	38520	125
	3	38503	1	38503-5	5	—	—
	4	38504	1	▲	—	—	—
	6	38506	1	▲	—	—	—
	12	38512	1	▲	—	—	—
#3	1	38601 ★	1	▲	—	—	—
	2	38602	1	38602-5	5	—	—
	3	38603 ★	1	▲	—	—	—
	4	38604 ★	1	▲	—	—	—
	6	38606 ★	1	▲	—	—	—
	12	38612	1	▲	—	—	—

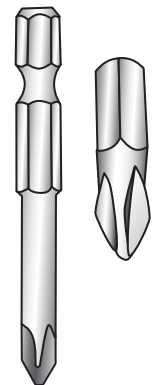

▲ Contact customer service for gravity feed jar availability.

★ Made in USA

SLOTTED HEX POWER BITS • 1/4" HEX SHANK



		Plastic Bag	
Size	Length	Part #	Qty
#6-7	2	38642 ★	1
#8-10	1	38561 ★	1
	2	38562	1
	3	38563	1
	4	38564	1
#10-12	1	38661 ★	1
	2	38662	1

★ Made in USA

HEX DRIVER BITS • MAGNETIC

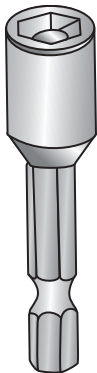

			Plastic Bag		3 Pk Clamshell		Bucket O' Bits	
Size	Length	Screw Size	Part #	Qty	Part #	Part #	Jar Qty	
1/4	1 3/4	#6-8	39004	1	39004-5	39104	50	
	3		39014	1	39014-5	39114	25	
	4		39024 ★	1	▲	—	—	
	6		39034 ★	1	▲	—	—	
5/16	1 3/4	#10-12	39005	1	39005-5	39105	50	
	2 -9/16		39015	1	39015-5	39115	25	
	4		39025 ★	1	▲	—	—	
	6		39035 ★	1	▲	—	—	
3/8	1 3/4	#14	39006	1	▲	39106	50	
	3		39016	1	▲	—	—	
	4		39026 ★	1	▲	—	—	
	6		39036 ★	1	▲	—	—	

★ Made in USA

TAMPERPROOF INSERT BITS • STAR, SPANNER & SOCKET PIN



Star Pin

Size	Shank Size	Part #	Qty
T-8H	¼ Hex	38983 ★	1
T-9H	¼ Hex	38984 ★	1
T-10H	¼ Hex	38985 ★	1
T-15H	¼ Hex	38988 ★	1
T-20H	¼ Hex	38990 ★	1
T-25H	¼ Hex	38992 ★	1
T-27H	¼ Hex	38994 ★	1
T-30H	¼ Hex	38996 ★	1
T-40H	¼ Hex	38998 ★	1
T-50H	¼ Hex	38999	1

Tri-Wing Bits

Size	Length	Shank Size	Part #	Qty
#4	1	¼ Hex	38704 ★	1
#5	1	¼ Hex	38705 ★	1

See Tamperproof Screws
pages 46-49



Spanner Head

Size	Length	Shank Size	Part #	Qty
#6	1	¼ Hex	31106 ★	1
#8	1	¼ Hex	31108 ★	1
#10	1	¼ Hex	31110 ★	1
#12	1	⅝ Hex	31112 ★	1
#14	1	⅝ Hex	31114	1



Socket Pin

Size	Shank Size	Part #	Qty
⅛	¼ Hex	92706 ★	1
⅙	¼ Hex	92707 ★	1
⅕	¼ Hex	92709 ★	1
⅜	¼ Hex	92710 ★	1
⅜	¼ Hex	92711 ★	1
½	¼ Hex	92718 ★	1
⅝	¼ Hex	92720 ★	1

★ Made in USA

HIGH SPEED JOBBER DRILLS • 118° POINT • STEEL



- Made from high speed tool steel.
- Polished flute for fast chip removal.
- 118° point, the economical choice.

Size	Part #	Pkg Qty
1/64	91597	12
1/32	91599 ★	12
3/64	91600 ★	12
1/16	91601 *	12
5/64	91602 *	12
3/32	91603 *	12
7/64	91604 *	12
1/8	91605 *	12
9/64	91606 *	12
5/32	91607 *	12
11/64	91608 *	12
3/16	91609 *	12
13/64	91610 *	12
7/32	91611 *	12
15/64	91612 *	12
1/4	91613 *	12
17/64	91614 *	12
9/32	91615 *	12

Size	Part #	Pkg Qty
19/64	91616	6
5/16	91617 *	6
21/64	91618 *	6
11/32	91619 *	6
23/64	91620 *	6
3/8	91621 *	6
25/64	91622 *	6
13/32	91623 *	6
27/64	91624 *	6
7/16	91625 *	6
29/64	91626 *	6
15/32	91627 *	6
31/64	91628 *	6
1/2	91629 *	6
#7	91707 ★	12
#21	91721 ★	12
#25	91725 ★	12
#29	91729 ★	12

★ Made in USA

*To set up display order one package of each asterisked item.

118° Metal Index Set			
Size	Part #	Number of Pieces	Pkg Qty
1/16-1/4 x 64ths	91801	13	1
1/16-1/2 x 64ths	91806	29	1

HIGH SPEED JOBBER DRILLS • 135° POINT • STEEL

- 135° split point is self-centering, reducing thrust.
- Better performance for just a few cents more than a 118° point.



TOOLS

Size	Part #	Pkg Qty
1/16	91901	12
5/64	91902	12
3/32	91903	12
7/64	91904	12
1/8	91905	12
9/64	91906	12
5/32	91907	12
11/64	91908	12
3/16	91909	12
13/64	91910	12
7/32	91911	12
15/64	91912	12
1/4	91913	12
17/64	91914	12
9/32	91915	12

Size	Part #	Pkg Qty
19/64	91916	6
5/16	91917	6
21/64	91918	6
11/32	91919	6
23/64	91920	6
3/8	91921	6
25/64	91922	6
13/32	91923	6
27/64	91924	6
7/16	91925	6
29/64	91926	6
15/32	91927	6
31/64	91928	6
1/2	91929	6

135° Metal Index Set			
Size	Part #	Number of Pieces	Pkg Qty
1/16–3/8 x 32nds	91802	15	1
1/16–1/4 x 64ths	91945	13	1
1/16–1/2 x 64ths	91949	29	1

TRINADO HEAVY-DUTY DRILLS • 135° POINT



Size	Description	Part #	Qty
1/16	Straight Shank	33304 ★	12
5/64	Straight Shank	33305 ★	12
3/32	Straight Shank	33306 ★	12
7/64	Straight Shank	33307 ★	12
1/8	Straight Shank	33308 ★	12
9/64	Straight Shank	33309 ★	12
5/32	Straight Shank	33310 ★	12
11/64	Straight Shank	33311 ★	12
3/16	Straight Shank	33312 ★	12

★ Made in USA

Size	Description	Part #	Qty
13/64	3 Flat Shank	33313 ★	12
7/32	3 Flat Shank	33314 ★	12
15/64	3 Flat Shank	33315 ★	12
1/4	3 Flat Shank	33316 ★	12
17/64	3 Flat Shank	33317 ★	12
9/32	3 Flat Shank	33318 ★	12
19/64	3 Flat Shank	33319 ★	12
5/16	3 Flat Shank	33320 ★	6
21/64	3 Flat Shank	33321 ★	6
11/32	3 Flat Shank	33322 ★	6
23/64	3 Flat Shank	33323 ★	6
3/8	3 Flat Shank	33324 ★	6
25/64	3 Flat Shank	33325 ★	6
13/32	3 Flat Shank	33326 ★	6
27/64	3 Flat Shank	92627 ★	6
7/16	3 Flat Shank	92628 ★	6
29/64	3 Flat Shank	92629 ★	6
15/32	3 Flat Shank	92630 ★	6
31/64	3 Flat Shank	92631 ★	6
1/2	3 Flat Shank	92632 ★	6

TRINADO HEAVY-DUTY DRILLS • METAL INDEX SET



- Black and bronze oxide surface treatments reduce friction.
- M7 industrial steel withstands high temperatures, maintains sharpness.
- Excellent for drilling in stainless and high carbon steels.

Size Range	No. Pcs	Part #	Qty
1/16–1/4 x 32nds	13	33333 ★	1
1/16–3/8 x 64ths	21	33335 ★	1
1/16–1/2 x 64ths	29	33336 ★	1

★ Made in USA

HEX DRILL SET • 135° SPLIT POINTS WITH HEX SHANKS • 7 PIECES

- Use a Quick-Change Drill Adapter (#39020) with hex shank drills to speed up interchange without needing to use drill chuck.

Size Range	No. Pcs	Part #	Qty
$\frac{1}{16}$ – $\frac{3}{32}$ – $\frac{1}{8}$ – $\frac{5}{32}$ – $\frac{3}{16}$ – $\frac{7}{32}$ – $\frac{1}{4}$	7	45432 ★	1

★ Made in USA

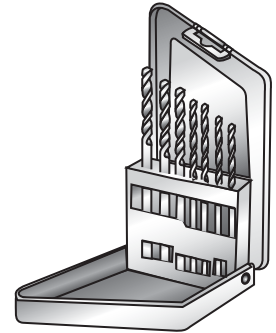

SPECIAL DRILL SETS • COBALT & TITANIUM DRILLS

Description	No. Pcs	Part #	Qty
Cobalt Drill Set (Gold) $\frac{1}{16}$ – $\frac{1}{4}$ x 64ths	13	91805	1
Titanium Drill Set (Yellow) $\frac{1}{16}$ – $\frac{1}{4}$ x 64ths	13	91807	1

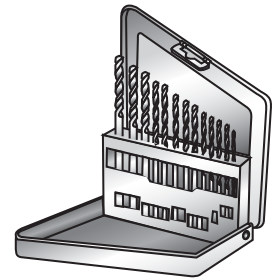

STRAIGHT SHANK CARBIDE DRILL BITS • ROTARY ONLY



- Straight shank design. Our most economical carbide bits.
- Fits any portable rotary drill or drill press – up to 1000 RPM.
- The right solution for drilling holes in tile, brick, block or cement.

★ Made in USA

Hole Size	Length	Part #	Pkg Qty
3/16	4	59904 ★	1
1/4	4	59906 ★	1
1/4	6	59908	1
5/16	4	59910	1
5/16	6	59912	1
3/8	4	59914	1
3/8	6	59916	1
1/2	4	59918	1
1/2	6	59920	1
5/8	6	59922	1

ROTARY/PERCUSSION CARBIDE DRILL BITS • RELTON™ QUALITY



- Highest quality tungsten carbide tips.
- Packaged in high-visibility plastic tubes.
- Exclusive RamTip™ design for a secure fit in rotary and percusion drills.
- Uniform cutting angles provide sharp, clean holes in concrete, brick or block.

★ Made in USA

Hole Size	Length	Part #	Pkg Qty
1/8	3	59720 ★	1
3/16	4	59722* ★	1
1/4	4	59724* ★	1
1/4	6	59726 ★	1
5/16	4	59728* ★	1
5/16	6	59730 ★	1
3/8	4	59732 ★	1
3/8	6	59734* ★	1
1/2	6	59736* ★	1
5/8	6	59738 ★	1
3/4	6	59740 ★	1

SDS ROTARY/HAMMER CARBIDE DRILL BITS • RELTON™ QUALITY

*See display offer on page 273



Hole Size	Length	Part #	Pkg Qty
3/16	4 1/2	59980 ★	1
1/4	4	59984 ★	1
1/4	6	59986* ★	1
1/4	14	59996 ★	1
5/16	6	59987 ★	1
3/8	6	59988* ★	1
3/8	14	59998 ★	1
1/2	6	59990* ★	1
1/2	14	59991 ★	1
5/8	8	59992* ★	1
3/4	8	59994 ★	1

*See display offer on page 273

★ Made in USA

BELL HANGER BITS • WIRING INSTALLATIONS • HIGH SPEED

		 Plastic Bag		
Hole Size	Length	Part #	Pkg Qty	
1/4	12	82204	1	
5/16	12	82205	1	
3/8	12	82206	1	
7/16	12	82207	1	
1/2	12	82208	1	
3/16	18	82303	1	
1/4	18	82304	1	
5/16	18	82305	1	
3/8	18	82306	1	
7/16	18	82307	1	
1/2	18	82308	1	
1/4	24	82404	1	
5/16	24	82405	1	
3/8	24	82406	1	
1/2	24	82408	1	

- Heat treated steel bits for maximum strength and durability.
- Perfect for boring through wood, metal, plaster and particle board.
- Hole in head of bit for easy pulling of wire.



Installation

- Drill a hole through walls, ceiling or floor.
- Attach wire through the hole at the end of the bell hanger.
- Withdraw drill and pull wire through.

FLEX SHANK DRILL BITS (FISH BITS) • SELF-FEED SCREW POINT

		 Plastic Bag		
Hole Size	Length	Part #	Pkg Qty	
3/8	54	92050	1	
1/2	54	92052	1	
9/16	54	92054	1	
3/4	54	92056	1	
3/8	72	92051	1	
1/2	72	92053	1	
9/16	72	92055	1	
3/4	72	92057	1	
Fish Bit Steering Guide		92058	1	

- Self-feeding screw point is brazed to a flexible spring steel shaft.
- Perfect for drilling holes and pulling wires and cables through walls, ceilings and floors.
- Steering guide bends and directs the fish bit in the right position.

Display:

- Free wall-mounted display with first time order of 8 bits. Please ask for part #95330 when placing order.

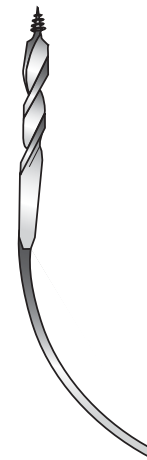

ELECTRICIAN'S POWER BITS • SELF-FEEDING SCREW POINT

			 Plastic Bag		
Hole Size	Length	Hex Shank	Part #	Pkg Qty	
5/8	8 1/2	5/16	80910	1	
1 1/16	8 1/2	5/16	80911	1	
3/4	8 1/2	5/16	80912	1	
13/16	8 1/2	5/16	80913	1	
7/8	8 1/2	5/16	80914	1	
1	8 1/2	5/16	80916	1	
1 1/8	8 1/2	5/16	80918	1	
1 1/4	8 1/2	5/16	80920	1	

- Single spur double twist drill with self-feeding screw point.

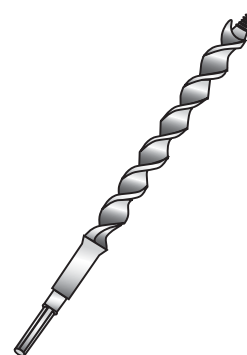

8" SHIP AUGER BITS • HEX SHANK • HEAT TREATED STEEL



- Single twist with self-feeding screw point cuts smoothly through wood.
- Super strong heat treated steel cuts through nails and other materials.
- Hollow center designed for fast flow of chips.
- Can be sharpened with a Cully auger bit sharpening file (Part #09382).

Hole Size	Length	Hex Shank	Part #	Pkg Qty
1/2	8	5/16	80608	1
9/16	8	7/16	80609	1
5/8	8	7/16	80610	1
3/4	8	7/16	80612	1
13/16	8	7/16	80613	1
7/8	8	7/16	80614	1
15/16	8	7/16	80615	1
1	8	7/16	80616	1
1 1/8	8	7/16	80618	1
1 1/4	8	7/16	80620	1
1 3/8	8	7/16	80622	1
1 1/2	8	7/16	80624	1

17" SHIP AUGER BITS • HEX SHANK • HEAT TREATED STEEL

Same as Bell Hanger packaging.



Hole Size	Length	Hex Shank	Part #	Pkg Qty
3/8	17	5/16	81806	1
7/16	17	5/16	81807	1
1/2	17	5/16	81808	1
9/16	17	5/16	81809	1
5/8	17	5/16	81810	1
11/16	17	7/16	81811	1
3/4	17	7/16	81812	1
13/16	17	7/16	81813	1
7/8	17	7/16	81814	1
15/16	17	7/16	81815	1
1	17	7/16	81816	1
1 1/16	17	7/16	81817	1
1 1/8	17	7/16	81818	1
1 1/4	17	7/16	81820	1
1 3/8	17	7/16	81822	1
1 1/2	17	7/16	81824	1

AUGER BIT EXTENSIONS & SHARPENING FILE

Same as Bell Hanger packaging.

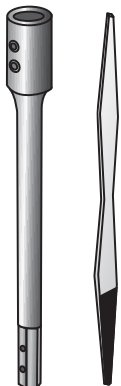

- Heavy duty, features a double-set screw lock, adds 9 1/2" to 24" to your bits.

Description	Length	Hex Shank	Part #	Pkg Qty
Auger Bit Extension	9 1/2	7/16	82009	1
Auger Bit Extension	12	7/16	82012	1
Auger Bit Extension	18	7/16	82018	1
Auger Bit Extension	24	7/16	82024	1
Auger Sharpening File	7	—	09382	1

Same as Bell Hanger packaging.

SAWTOOTH SELF-FEEDING BITS • THREE MILLED FLATS

Hole Size	Length	Part #	Pkg Qty
1 3/8	5	86922 ★	1
1 1/2	5	86924 ★	1
1 3/4	5	86928 ★	1
2 1/8	5	86934 ★	1
2 9/16	5	86941 ★	1
3 1/8	5	86958 ★	1

★ Made in USA

- Open design whisks away wood chips.
- Fine thread screw point provides excellent control.
- Tapered for easy removal.

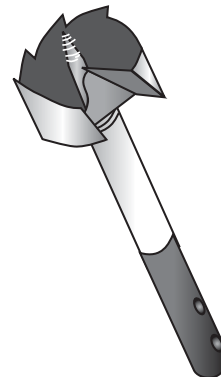

SPEEDBOR 2000™ WOOD BITS • IRWIN 2000

Hole Size	Length	Part #	Pkg Qty
1/4	6	85004 ★	1
5/16	6	85005 ★	1
3/8	6	85006 ★	1
7/16	6	85007 ★	1
1/2	6	85008 ★	1
9/16	6	85009 ★	1
5/8	6	85010 ★	1
11/16	6	85011 ★	1
3/4	6	85012 ★	1
13/16	6	85013 ★	1
7/8	6	85014 ★	1
15/16	6	85015 ★	1
1	6	85016 ★	1
1 1/8	6	85018 ★	1
1 1/4	6	85020 ★	1
1 3/8	6	85022 ★	1
1 1/2	6	85024 ★	1
12" Extension		88602 ★	1
6" Extension		88703 ★	1

★ Made in USA

- Extended spurs scribe the hole for faster chip clearance.
- Precision-ground shanks run true with no run-out or wobble.
- Fits 1/4" and larger power drives.
- Micro-groove point moves quickly through hardwood, softwood, plywood and drywall.

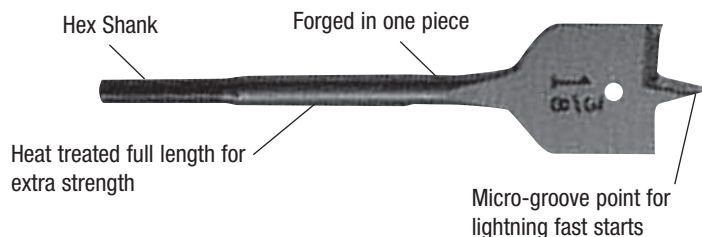

STEP DRILLS • 2-FLUTE SPLIT TIP DESIGN • HIGH SPEED STEEL

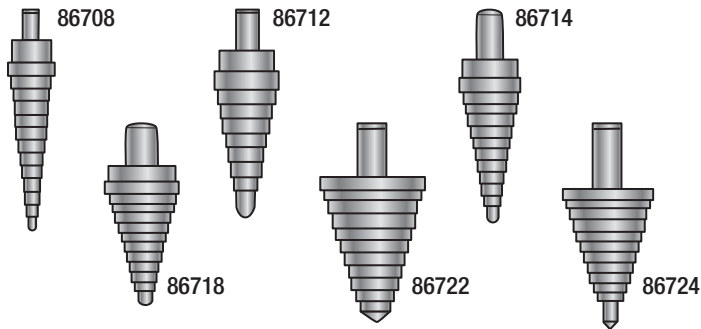

- Will drill through 10 gauge mild steel or stainless steel.
- Three flats shank for non-slip grip.
- Self-drilling. Requires no pre-punching.

Applications		
• Metal Studs	• Switchboxes	• Junction Boxes
• Lighting	• Fixtures	

Hole Size Range	Increments	Number of Steps	Shank Size	Step Thickness	Part #	Pkg Qty
1/8–1/2	1/32	13	1/4	1/8	86708	1
1/4–3/4	1/16	9	3/8	1/8	86712	1
3/16–7/8	1/16	12	3/8	1/8	86714	1
7/16–1 1/8	1/16	12	3/8	1/8	86718	1
3/4–1 3/8	1/16	11	3/8	1/8	86722	1
1/4–1 1/2	1/16	11	3/8	1/8	86724	1

TOOLS

CONE BITS • 2-FLUTE DESIGN • 3 FLATS SHANK

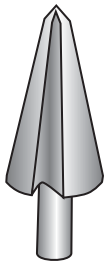

- Quickly creates a pilot hole for knockout applications.
- Three flats shank fits securely in chuck for a sure grip.
- Double fluted cone cuts clean, concentric holes.

Hole Size Range	Part #	Pkg Qty
3/8–7/8	86814	1

HOLE SAW ARBORS & PILOT DRILLS

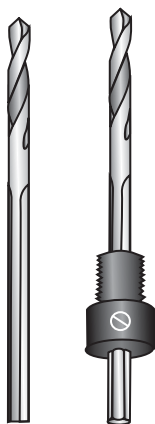

Description	Shank Size	Thread Size	Drill #	Chuck Size	Arbor Ext.	MFG #	Part #	Qty
Arbors	1/4 Round	1/2-20	MPD4	1/4	—	M24K	86540* ★	1
Arbors	1/4 Hex	1/2-20	MPD4S	1/4	—	M24	86544* ★	1
Arbors	3/8 Hex	1/2-20	MPD4S	3/8	—	M34	86554* ★	1
Arbors	7/16 Hex	1/2-20	MPD4	1/2	ME12	M44K	86556* ★	1
Arbors	7/16 Hex	1/2-20	MPD4	1/2	ME12	M44	86558* ★	1
Arbors	7/16 Hex	5/8-18	MPD4	1/2	ME12	M45P	86545* ★	1
Arbors	3/8 Hex	5/8-18	MPD4S	3/8	—	M35PS	86560* ★	1
Arbors	5/8 Hex	5/8-18	MPD4	3/4	—	M55P	86566* ★	1
1/4 x 4 1/2 Pilot Drill	—	—	—	—	—	MPD4	86511 ★	1
1/4 x 2 3/4 (M24) Pilot Drill	—	—	—	—	—	MPD4S	86514 ★	1
12" Arbor Extension	—	—	—	—	—	ME12	86512 ★	1

*Includes a 1/4" pilot drill.

★ Made in USA

VARIABLE PITCH HOLE SAWS • BI-METAL • 4-6 PITCH

- Variable pitch (4 and 6 teeth per inch). Cuts 45% faster than a conventional 6-pitch saw.
- 1½" cutting depth – Designed for use in wood, plastic, steel, tin, aluminum and fiberglass.

Hole Size	Arbor #	MFG #	Part #	Qty
9/16	M24	AV09	86209 ★	1
3/4		AV12	86212 ★	1
7/8		AV14	86214 ★	1
1	M24K	AV16	86216 ★	1
1 1/16	M44	AV17	86217 ★	1
1 1/8	M44K	AV18	86218 ★	1
1 3/16		AV19	86219 ★	1
1 1/4	M35PS	AV20	86220 ★	1
1 3/8		AV22	86222 ★	1
1 1/2		AV24	86224 ★	1
1 5/8	M45	AV26	86226 ★	1
1 3/4	M45P	AV28	86228 ★	1
2	M55	AV32	86232 ★	1
2 1/8		AV34	86234 ★	1
2 1/4	M44K	AV36	86236 ★	1
2 3/8		AV38	86238 ★	1

Hole Size	Arbor #	MFG #	Part #	Qty
2 1/2	M45P M55P M44K	AV40	86240 ★	1
2 5/8		AV42	86242 ★	1
2 3/4		AV44	86244 ★	1
2 7/8		AV46	86246 ★	1
3		AV48	86248 ★	1
3 1/4		AV52	86252 ★	1
3 3/8		AV54	86254 ★	1
3 1/2		AV56	86256 ★	1
3 5/8		AV58	86258 ★	1
3 3/4		AV60	86260 ★	1
4		AV64	86264 ★	1
4 1/8		AV66	86266 ★	1
4 1/4		AV68	86268 ★	1
4 3/8		AV70	86270 ★	1
4 1/2		AV72	86272 ★	1
4 3/4		AV76	86276 ★	1
5		AV80	86280 ★	1
5 1/4		AV84	86284 ★	1
5 1/2	AV88	86288 ★	1	
5 3/4	AV92	86292 ★	1	
6	AV96	86296 ★	1	
6 5/8	AV98	86298 ★	1	



Premium Morse Real McCoy (TA) Hole Saws with built-in arbors available by special order.

See display offer on page 273

★ Made in USA

ELECTRICIAN'S HOLE SAW KIT

- Kit contains 6 of the most popular variable pitch hole saws.
- Packaged in a durable plastic carrying case.



Kits	
Part #	Description
86522 ★ (8 Piece Kit)	Pipe Entrance Kit (AV02E) For Pipe 1/2"–2"
	7/8" Hole Saw 1 3/8" Hole Saw 2" Hole Saw M44 Arbor 1 1/8" Hole Saw 1 3/4" Hole Saw 2 1/2" Hole Saw M45P Arbor

★ Made in USA

MASTER ELECTRICIAN'S HOLE SAW KIT



- Kit contains 10 of the most popular variable pitch hole saws.
- Includes two 7/16" hex arbors – 1/2"-20 and 5/8"-18 and a 1/4 round 1/2"-20 arbor.

Kits				
Part #	Description			
Pipe Entrance Kit (AV08E) – For Pipe 1/2"–4"				
86528 ★ (13 Piece Kit)	7/8" Hole Saw	2" Hole Saw	4 1/8" Hole Saw	M45P Arbor
	1 1/8" Hole Saw	2 1/2" Hole Saw	4 1/2" Hole Saw	
	1 3/8" Hole Saw	3" Hole Saw	M24K Arbor	
	1 3/4" Hole Saw	3 5/8" Hole Saw	M44 Arbor	

★ Made in USA

MAINTENANCE HOLE SAW KIT • PLUMBERS & ELECTRICIANS



- Kit contains 9 plumbing and electrical sizes.
- Includes 12" arbor extension.
- The most versatile choice for electricians and plumbers working with 1/2" to 2" pipe and conduit.

Kits				
Part #	Description			
Pipe Entrance Kit (AV100) For Pipe 1/2"–2"				
86530 ★ (13 Piece Kit)	3/4" Hole Saw	1 1/2" Hole Saw	2 1/2" Hole Saw	ME12 Ext
	7/8" Hole Saw	1 3/4" Hole Saw	M24K Arbor	
	1 1/8" Hole Saw	2" Hole Saw	M44 Arbor	
	1 3/8" Hole Saw	2 1/4" Hole Saw	M45P Arbor	

★ Made in USA

CARBIDE GRIT HOLE SAWS



- The perfect choice for installing recessed lighting. Carbide cuts through ceiling tiles without catching.
- Outstanding for cutting through steel, copper and aluminum.
- Gulleted edge with 1 3/8" cutting depth (86302, 86303 and 86304 do not have a gulleted edge).
- Requires separate arbor (see below).

Hole Diameter	For Installing These Light Fixtures	Arbor #	MFG #	Part #
7/8"	—	86545 ★ or 86556 ★	ATCG14	86314 ★
1 1/8"	—		ATCG18	86322 ★
1 3/8"	—		ATCG22	86328 ★
1 3/4"	—		ATCG28	86338 ★
3 5/8"	3-0 Outlet Boxes	86545 ★ or 86556 ★	ATCG58	86305 ★
4 1/8"	Capri, 4-0 Outlet Boxes		ATCG66	86306 ★
4 3/8"	Capri, Halo, Juno, Marco		ATCG70	86301 ★
6 3/8"	Capri, Halo		ATCG104	86302 ★
6 5/8"	Juno, Progress		ATCG106	86303 ★
6 7/8"	Capri, Lightolier, Lithonia, Progress, Prescolite, Marco		ATCG110	86304 ★

Great For

- Cement Board
- Plaster • Drywall
- Stucco • Plywood
- Ceiling Tiles
- Acoustical Tiles

CARBON STEEL TAPS • PLUG STYLE

- High speed steel stays sharp even after tapping hardened alloys.
- All taps are national coarse except 10-32 National Fine.

Carbon Steel Tap			Corresponding Drill		
Description	Part #	Pkg Qty	Drill Size	Part #	Qty
6-32	68037	5	#36	91736	12
8-32	68039	5	#29	91729	12
10-24	68041	5	#25	91725	12
10-32	68042	5	#21	91721	12
¼-20	68047	5	#7	91707	12
⅝-18	68049	5	"F"	9170F	12
⅜-16	68080	5	⅝" 11	91617	6
½-13	68084	5	⅔" 11	91624	12



CARBON STEEL TAP WRENCHES • PLUG STYLE

Description	Part #	Qty
Tap Handle for 6-32 to ¼-20	69902	1
Tap Handle for ¼-20 to ½-13	69904	1

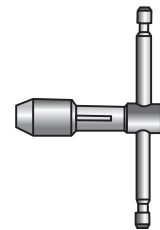

CARBON STEEL TAPS & DRILL SET

- Essential kit for every electrical contractor.
- Contains the 6 most popular tap sizes with corresponding twist drills and universal T-Handle.

Part #	Description
	 Kits
	Tap & Drill Bit Set
96042 ★ (13 Piece Kit)	Carbon Plug Taps: 4-40, 6-32, 8-32, 10-24, 10-32, ¼-20 (6 Pieces) High Speed Twist Drills: #43, #36, #29, #25, #21, #7 (6 Pieces) T-Handled Wrench (1 Piece)



HEX SHANK TAPS

★ Made in USA

- Specially designed for the Quick Change Drill Adapter (page 140).
- Fits all hex shank power and hand tools.

Description	Part #	Qty
6-32 Hex Shank Power Tap	68036 ★	5
8-32 Hex Shank Power Tap	68038 ★	5
10-24 Hex Shank Power Tap	68040 ★	5
10-32 Hex Shank Power Tap	68044 ★	5
¼-20 Hex Shank Power Tap	68046 ★	5
Hex Shank Power Tap Kit (Includes 6-32, 8-32, 10-24, 10-32, ¼-20)	68096 ★	1



★ Made in USA

SCREW EXTRACTOR & DRILL BIT SET

- Removes broken screws and bolts.
- Insert into pre-drilled hole and back out with a wrench. Broken part will dislodge.



 Kits	
Part #	Description
96046 ★ (10 Piece Kit)	Screw Extractor Kit Screw Extractors: #1, #2, #3, #4, #5 (5 Pieces) Twist Drills: 5/64, 7/64, 5/32, 1/4, 17/64 (5 Pieces)

★ Made in USA

DAMAGED SCREW REMOVAL SET



- For phillips, slotted, star and square screws.
- Hardened steel bits for secure bit.
- 1/4" hex shank fits drills, sockets and screwdrivers.
- Sizes #1, #2 and #3 screw removers in handy storage case.

Description	Part #	Qty
3 Piece Damaged Screw Removal Set	96047	1

DRYWALL JAB SAW



- Extra rigid 6" carbon steel blade.
- Sharp point for easy penetration.
- Ergonomic no slip handle.

Description	Part #	Qty
6" Drywall Jab Saw	37450	10

HACKSAW BLADES • BI-METAL CONSTRUCTION

- Cuts wood, plastic or any machinable metal, including conduit, stainless steel tubing, angle iron and copper tubing.
- Tooth hardness RC 65-67.
- Outperforms leading hacksaw brands.

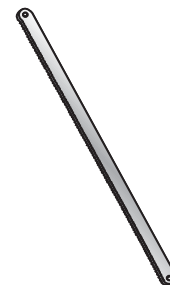

Description	Teeth/Inch	Part #	Pkg
12" x 1/2" W x .025"	18	86618 ★	10
12" x 1/2" W x .025"	24	86624 ★	10
12" x 1/2" W x .025"	32	86632 ★	10

★ Made in USA

HACKSAW FRAME • LIGHT WEIGHT • HIGH TENSION

- Locking screw design with multiple pin locations and tensioning handle.
- Standard or angled blade mounting.
- Stores blade or secures blade for job sawing.

Description	Part #	Qty
High-Tension Hacksaw Frame	86640 ★	1

★ Made in USA



RECIPROCATING SAW BLADES • BI-METAL • 1/2" SHANK

Length	Teeth/Inch	Use	Application	Part #	Pkg
4	14	Metal	1/8" Thick and Above	86633 ★	5
6	14	Metal	1/8" Thick and Above	86634 ★	5
4	18	Metal	18 Gauge to 1/8"	86637 ★	5
6	18	Metal	18 Gauge to 1/8"	86638 ★	5
4	24	Metal	18 Gauge and Under	86641 ★	5
6	24	Metal	18 Gauge and Under	86644 ★	5
8	10	Wood/Metal	All Woods, Plastic, Alum	86650 ★	5
3 1/2	17	Wood/Metal	Scroll Cuts Wood, Alum	86655 ★	5
6	5-7	Wood	Plaster w/Metal Lath	86660 ★	5
12	5-7	Wood	Plasterboard	86665 ★	5
6	6	Plaster	Sheetrock	86670 ★	5

★ Made in USA

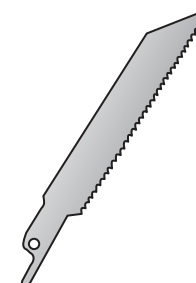

PVC CABLE SAW

- Flexible handles allow cutting in hard to reach situations.
- Economy priced.

Description	Part #	Unit	Qty
PVC Cable Saw	96260 ★	1	24

★ Made in USA

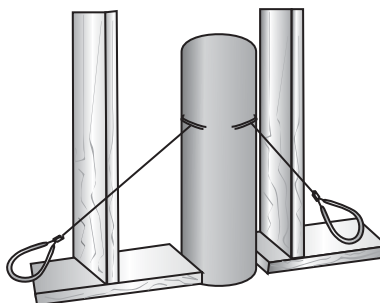

ACCUSHARP® KNIFE SHARPENER



- Fast, effective results with twin blades set at optimal 21° cutting angle.
- Form fitted handle fits either hand safely and securely.
- Safe and easy to use with durable full sized knuckle guard.
- Tungsten carbide blades. Diamond-honed and precision formed with an RC of 97.
- Great for sharpening knives, shovels, garden tools and axes.
- See page 272 for display details.

Description	Part #	Case Qty
Accusharp® Knife Sharpener	37400 ★	12
Accusharp® Knife Sharpener Camo	37400C ★	12
Replacement Blades (Set of 2)	37404 ★	12

Can be ordered individually.

★ Made in USA

QUICKBLADE™ • ERGONOMIC UTILITY KNIFE



- Spring loaded hinge.
- Packed with a straight blade.
- Locking knob is flush with knife handle and stays attached to knife.
- Counter display available at no additional charge with orders of 18.

Description	Part #	Qty
Autoload Utility Knife	90214	1
Ergonomic Utility Knife	90215	1
Straight Edge Blades	90228 ★	5 Pk
Straight Edge Blades	90229 ★	100 Pk

★ Made in USA

TITAN™ FOLDING POCKET UTILITY KNIFE



- Change blade with the push of a button, no tools necessary.
- Folds compact for easy storage and portability.
- Blade locks in open position for safety.
- Uses standard utility blades.
- Belt clip included.

Description	Part #	Qty
Titan™ Folding Pocket Utility Knife	37975	1



BONUS!
5 FREE blades in a handy dispenser!



Folds compact for safety

URASEAL SPLICE KITS

TOOLS



ES137S ★

Smaller butt and branch splice applications.



ES200S ★

Butt and branch splice applications.



ES200SV ★

Perfect for small hard-to-reach areas. The closure snaps into place over the splice. Can be used for butt, branch or through splice applications.



ES1150 ★

For a range of cable sizes from 8-4/0 and 250 mcm single service conductors.

Wire Type	Butt Splice Configuration			Through Splice Configuration	
	ES137S	ES200S	ES200SV	ES200SV	ES1150
	Number of Conductors (Max.)			Number of Conductors (Max.)	
18-16	Up to 10	Up to 20	Up to 14	Up to 14	—
14-12	6	12	9	9	—
10	4	8	6	6	—
8	3	6	4	4	4
6	2	2	2	2	3
4	2	2	2	2	2
3	2	2	2	2	2
2	1	2	2	2	2
1	1	2	2	2	2
1/0	—	—	—	—	2
2/0	—	—	—	—	2
3/0	—	—	—	—	2
4/0	—	—	—	—	2
250 mcm	—	—	—	—	2

★ Made in USA

ABSOLUTE PROTECTION FOR ANY SPLICE IN A WET OR DAMP ENVIRONMENT

Fix any broken cable using Uruseal's Shake N' Seal splice protection system. Developed specifically for the electrical market, this new splicing system provides a permanent seal that is 100% water tight.



This proven technology has been used in similar sealing applications for over 30 years without failure!

Replaces the sheath integrity with an absolute seal around the splice or damaged cable. Add a length of wire to a run, or build a branch splice. Safe and easy to use. No need for a torch or open flame.

Easy as...



Features

- Submersible in water
- No mess
- Immediate burial
- Safe, no torch
- Permanent Seal
- Set-up less than 2 minutes!



TAPE MEASURE



- Tough, impact resistant plastic case.
- Comfortable sleeve for better grip.
- Hands-free blade lock.



Description	Part #	Qty
Tape Measure 25" x 1"	86980	1

QUICKIE TIE-DOWN STRAPS



- Patented, self-locking rope pulley.
- The quickest, easiest tie-down on the market.
- Comes with 8 feet of high quality rope to fasten a variety of loads.
- Carries a one year warranty on manufactured parts, so you can be assured of quality.
- 1/4" – 150 lb (Safe Working Load)
- 3/8" – 400 lb (Safe Working Load)

Description	Part #	Unit	Qty
1/4" Quickie Tie Down Strap	37216	1	12
3/8" Quickie Tie Down Strap	37218	1	12

TARP STRAPS



- Exceptional performance even under the harshest conditions.
- Features pre-inserted "S" hooks.

Description	Part #	Qty
9" Rubber Tarp Strap	37204 ★	1
15" Rubber Tarp Strap	37205 ★	1
20" Rubber Tarp Strap	37206 ★	1
24" Rubber Tarp Strap	37207 ★	1
31" Rubber Tarp Strap	37208 ★	1
41" Rubber Tarp Strap	37209 ★	1

★ Made in USA

YELLOW POLYPROPYLENE PULL ROPE

Rope Diameter	Length (ft)	Work Load (lbs)	Break Point (lbs)	Part #
3/16	250	72	800	67800
3/16	600	72	800	67802
3/16	1000	72	800	67804
3/16	1200	72	800	67806
1/4	250	113	1250	67812
1/4	600	113	1250	67814
1/4	1000	113	1250	67816
1/4	1200	113	1250	67818
1/4	2400	113	1250	67820
1/4	4000	113	1250	67822
1/4	5000	113	1250	67824
3/8	300	243	2700	67826
3/8	600	243	2700	67828
3/8	1200	243	2700	67830
3/8	2400	243	2700	67832
3/8	3600	243	2700	67834
1/2	300	378	4200	67836
1/2	600	378	4200	67838
1/2	1200	378	4200	67840
5/8	600	558	6200	67842
5/8	1200	558	6200	67844
3/4	600	756	8500	67846
1	600	1260	14000	67848



- Safety yellow
- Light weight
- Strong
- Rot Proof
- Water, oil and gas resistant
- Available in all popular sizes
- Longer lengths available

TOOLS

POLYESTER PULLING TAPE/MULE TAPE

- Durable foot markings for accurate measurements.
- Flat construction and lubricants work to minimize friction and duct cutting.
- Soft construction for easy handling.

Width	Length (ft)	Tensile (lbs)	Part #	MFG #
1/2	500	1250	67680 ★	P1250W
1/2	1500	1250	67682 ★	P1250W
1/2	3000	1250	67684 ★	P1250W
5/8	500	1800	67686 ★	P1800W
5/8	1500	1800	67688 ★	P1800W
5/8	3000	1800	67690 ★	P1800W
3/4	500	2500	67692 ★	P2500W
3/4	1500	2500	67694 ★	P2500W
3/4	3000	2500	67696 ★	P2500W



★ Made in USA

POLYESTER CONDUIT MEASURING TAPE



- Durable foot markings for accurate measurements.
- Low elongation polyester.

Length (ft)	Tensile (lbs)	Part #	MFG #	Unit	Case Qty
3000	140	67700 ★	P160S	1	8

★ Made in USA

POLYPROPYLENE BLOW TWINE



- Lightweight construction.
- Blows easily into conduit.

Description	Length (ft)	Tensile (lbs)	Part #	MFG #	Unit
Two Ply (Pail)	6500	200	67699 ★	BL200BKT	1

★ Made in USA

LINE PACKAGES



- 1/2" red, 3/4" yellow, 1" white.
- Line packages combine piston and string into a single package. With a portable blower you can blow or vacuum the nylon line and pull a rope through.
- Nylon Fishline features center feed for fast payout.

Nylon Fishline			
Size	Strength	Part #	No./Pkg
2150'	85# Tensile	67730 ★	1 Spool

★ Made in USA

Size	Part #	No./Pkg
1/2 x 75'	67710 ★	10
1/2 x 150'	67712 ★	10
3/4 x 75'	67714 ★	10
3/4 x 200'	67716 ★	5
3/4 x 300'	67718 ★	5
3/4 x 450'	67720 ★	5
1 x 75'	67722 ★	10
1 x 200'	67724 ★	5
1 x 300'	67726 ★	5
1 x 450'	67728 ★	5

FOAM CONDUIT PISTONS

Size	Part #	No./Pkg
1/2	67740 ★	5
3/4	67742 ★	5
1	67744 ★	5
1 1/4	67746 ★	2
1 1/2	67748 ★	1
2	67750 ★	1
2 1/2	67752 ★	1
3	67754 ★	1
3 1/2	67756 ★	1
4	67758 ★	1
5	67760 ★	1
6	67762 ★	1

- Power fishing pistons are used with a vacuum or blower to pull line through a conduit run.
- Fits most conduits 1/2" through 6".
- Eyes or hooks at both ends.
- Tough foam piston cleans its own path and provides an air tight seal.



★ Made in USA

RECEPTICAL SHIM

Gravity Feed Jar		
Description	Part #	Jar Qty/Std Pk
25 Strips of 8 Shims per Jar	CPRS25J ★	25/200

- Each strip has 8 foldable (tear off) segments.
- Each segment provides 1/8" spacing.
- No need to remove screw.
- Low density polyethylene; non-conductive.

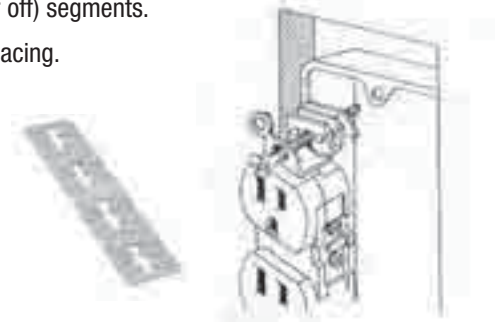

★ Made in USA

NON-METALLIC SHEATHED CABLE CONNECTORS

- Industry leading 60lb wire pull-out vs. 25lb of several competitors.
- Long body with rounded edges = easier and safer installations.
- Capacities:
RC50 One Cable: 14/2, 12/2, 10/2, 14/3, 12/3, 10/3
Two cable: 14/2, 12/2, 14/3
RC75 One Cable: 8/3 – 6/3
- CSA approved.
- VO fire rated.

RC50 Common Uses:

- Load Centers
- Down Lights (i.e. Cans)
- Strip Lights, Exhaust Fans
- Any 1/2" K/O where non-metallic cable is allowed.

RC75 Common Uses:

- Load Centers
- Sub Feeds
- Electric Ranges
- Electric Ovens
- A/C Units
- Any 3/4" K/O where non-metallic cable is allowed.



Description	Hang Tag Bag		5x11 Plastic Jar	
	Part #	Std Pkg	Part #	Std Pkg
1/2" Non-Metallic Sheathed Connector	RC50	100	RC50J	275
3/4" Non-Metallic Sheathed Connector	RC75	50	RC75J	165

PLASTIC STEEL STUD BUSHINGS



- Patented one piece design means no mating of pieces and only one piece to keep track of.
- Easy and quick installation and removal.
- UL and CSA approved.
- VO fire rated.

	Hang Tag Bag	5x11 Plastic Jar		
Description	Part #	Std Pkg	Part #	Std Pkg
Round Steel Stud Bushing	RSS	100	RSSJ	200
Square Steel Stud Bushing	SSS	100	SSSJ	125

ANTI-SHORT BUSHINGS



- Prevents damage to wire installation.
- Constructed of thermoplastic material.

Description	Fits Cable	Part #	Jar Qty/ Std Pk
Size 0 Anti-Short Bushing	14/2, 14/3, 12/2, 12/3	67420J	50/600
Size 1 Anti-Short Bushing	14/4, 6/1, 4/1	67421J	50/600
Size 2 Anti-Short Bushing	12/4, 10/2, 10/3, 2/1	67422J	50/300
Size 3 Anti-Short Bushing	10/4, 8/2, 8/3, 1/1	67423J	25/150
Size 4 Anti-Short Bushing	8/4, 6/2, 6/3, 6/4, 4/2, 4/3	67424J	25/150

KNOCK-OUT BUSHINGS



- Converts raw-edged holes to smooth, neat, insulated holes.
- Locking fingers snap into holes with fingertip pressure.
- Withstands a push back force of 35 lbs.
- Insulates and mechanically protects electrical and telecommunication cables, tubing, hose, rope and utility lines.

Description	Part #	Box Qty
½" Knock Out Bushing	95090	100
¾" Knock Out Bushing	95092	100
1" Knock Out Bushing	95094	50
1¼" Knock Out Bushing	95096	25
1½" Knock Out Bushing	95098	10
2" Nylon Knock Out Bushing	95100	10
2½" Nylon Knock Out Bushing	95102	10

COLOR-CODED PVC ELECTRICAL TAPE • “PHASE TAPE”

- 7mil tape features excellent insulation and anti-corrosion qualities. UL-Listed.
- An economical tape that remains flexible even in extreme temperatures. Can be applied from 40°F to 176°F.
- Cellophane wrapped in sleeves of 10.

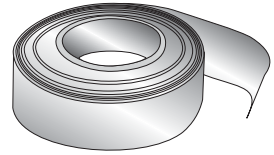

Size	Color	Part #	Unit	Sleeve Qty
¾ x 60'	Brown	94361	1 Roll	10
¾ x 60'	Red	94362	1 Roll	10
¾ x 60'	Orange	94363	1 Roll	10
¾ x 60'	Yellow	94364	1 Roll	10
¾ x 60'	Green	94365	1 Roll	10
¾ x 60'	Blue	94366	1 Roll	10
¾ x 60'	Grey	94368	1 Roll	10
¾ x 60'	White	94369	1 Roll	10

TOOLS

BLACK PVC ELECTRICAL TAPE • PREMIUM & ECONOMY

- Both tapes feature UL-Listed 7 mil PVC with excellent insulation and anti-corrosion qualities.
- Premium tape offers greater adhesion and elasticity, especially in cold in weather environments.

Size	Color	Part #	Sleeve Qty
¾ x 60'	Black Economy	94315	10
¾ x 60'	Black Premium	94317	10

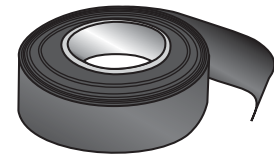

RUBBER TAPE • BLACK

- Rubber tape has low adhesive quality, designed to be used as a surface covering with friction tape or vinyl tape.
- 30mil UL-Listed tape suitable for use up to 176°F.

Size	Color	Part #	Unit	Sleeve Qty
¾ x 22'	Black	94325	1 Roll	10



FRICION TAPE • CONTRACTOR GRADE

- Strong adhesive quality often used for wrapping low-voltage splices.

Size	Color	Part #	Unit
¾ x 60'	Black	94320	1 Roll



DUCT TAPE • INDUSTRIAL GRADE • CLOTH LAMINATE

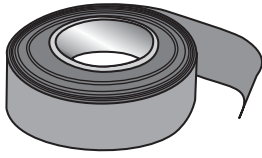

- 11 mil industrial grade tape is coated with rubber base adhesive for extra adhesion.
- Economy tape is 8 mil.

Size	Description	Part #	Unit	Pkg Qty
2" x 60 Yards	Premium	94357	1 Roll	24
2" x 60 Yards	Standard	94396 ★	1 Roll	24
2" x 60 Yards	Economy	94394 ★	1 Roll	24

★ Made in USA

CARTON SEALING TAPE • GENERAL PURPOSE TAPE

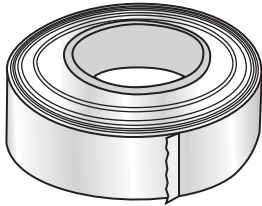

- Good all-purpose tape for packaging, mailing and for quick fix solutions.
- Will fit most standard hand-held packaging tape dispensers.

Size	Description	Part #	Unit	Pkg Qty
2" x 110' Yards	Clear	94330 ★	1 Roll	6

★ Made in USA

STRAPPING TAPE • GLASS FILAMENT • NON-TEARING

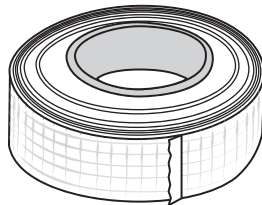

- Excellent choice for bundling lumber and pipes.
- Fits most hand-held strapping tape dispensers.
- Abrasion-resistant tape is reinforced with glass yard filaments for maximum strength.

Size	Part #	Unit	Pkg Qty
¾" x 60 Yards	94340 ★	1 Roll	12

Tensile Strength = 100lbs/inch

★ Made in USA

PIPE WRAP



- Protects overhead and buried pipe joints, conduit and couplings.
- Resistant to oil, water, sun and corrosive materials.
- Universal Plumbing Code approved.

Description	Part #	Unit	Std Pack
1" x 100' 10 mil UPC Approved Pipe Wrap	94433	1 Roll	12
2" x 100' 10 mil UPC Approved Pipe Wrap	94434	1 Roll	6
4" x 100' 10 mil UPC Approved Pipe Wrap	94435	1 Roll	3
2" x 100' 20 mil UPC Approved Pipe Wrap	94436	1 Roll	6

BARRICADE & CAUTION TAPE

Size	Legend	Color	Part #	Unit	Std Pack
3" x 1000'	"Gas Line Below"	Yellow	94607	1 Roll	8
6" x 1000'	"Gas Line Below"	Yellow	94614	1 Roll	4
3" x 1000'	"Caution-Caution-Caution"	Yellow	94625	1 Roll	8
6" x 1000'	"Caution High Voltage"	Yellow	94628	1 Roll	8



Other messages available.

UNDERGROUND BURIAL TAPE • 4 MIL CONTINUOUS REPEAT WARNINGS

Size	Legend	Color	Part #	Unit	Std Pack
3" x 1000'	"Buried Electrical Line"	Red	94605	1 Roll	8
3" x 1000'	"Buried Electrical Line"	Yellow	94606	1 Roll	8
6" x 1000'	"Buried Electrical Line"	Red	94615	1 Roll	4
6" x 1000'	"Buried Electrical Line"	Yellow	94616	1 Roll	4
3" x 1000'	"Buried Telephone Line"	Orange	94617	1 Roll	8
6" x 1000'	"Buried Telephone Line"	Orange	94618	1 Roll	4



Other messages available.

UNDERGROUND DETECTABLE TAPE • 5 MIL FOIL BONDED POLYETHYLENE

Size	Legend	Color	Part #	Unit	Std Pack
3" x 1000'	"Buried Electrical Line"	Silver w/Red Stripes	94635	1 Roll	8
6" x 1000'	"Buried Electrical Line"	Silver w/Red Stripes	94636	1 Roll	4
3" x 1000'	"Buried Water Line Below"	Silver w/Blue Stripes	94638	1 Roll	8
6" x 1000'	"Buried Water Line Below"	Silver w/Blue Stripes	94639	1 Roll	4
3" x 1000'	"Buried Telephone Line Below"	Silver w/Orange Stripes	94640	1 Roll	8
6" x 1000'	"Buried Telephone Line Below"	Silver w/Orange Stripes	94641	1 Roll	4



Other messages available.

SAFETY



INFINITY PROTECTIVE EYEWEAR

Attractive and comfortable, these glasses are appealing to the eye and face while serving as a tough optical shield of protection.

- High-grade Polycarbonate construction.
- Meets and exceeds ANSI Z87+ high-impact specifications.
- Lenses provide 99.9% protection from harmful UVA/UVB rays.
- Comfort fit rubber nosepiece.
- Nonslip rubber temple ends.
- Ultralight frame design for comfortable fit.

Part #	Crossfire® Model #	Description
19100	241	Black Frame w/Smoke Lens
19101	263	Black Frame w/Silver Mirror Lens
19102	2117	Brown Frame w/HD Brown Mirror Lens
19103	2812	Black & Orange Frame w/Gold Mirror Lens



SNIPER PROTECTIVE EYEWEAR

Designed for tactical vision, these glasses serve as a stylish option for the sniper who seeks long lasting eye protection.

- TR-90 ultraflex, ultralight frame technology.
- Meets and exceeds ANSI Z87+ high-impact specifications.
- Lenses provide 99.9% protection from harmful UVA/UVB rays.
- Comfort fit Rubber nosepiece.
- Soft, nonslip Rubber temple ends.

Part #	Crossfire® Model #	Description
19105	9117	Brown Frame w/Brown Mirror Lens
19106	9141	Brown/Camo Frame w/Smoke Lens



ES4 SAFETY GLASSES

Crossfire® ES4 Safety Glasses are designed for all environments and features an adjustable nose piece, ultralight frame and 100% visually correct lenses.

- Half frame

Part #	Crossfire® Model #	Description
19135	2141	Black Frame w/Smoke Lens
19136	2169	Black Frame w/HD Red Mirror Lens
19137	211125	Brown Frame w/HD Brown Mirror Lens



ES5 SAFETY GLASSES

Crossfire® ES5 Safety Glasses are designed for outdoor sports and features a polished look with a light weight fit. The sleek framework provides substantial

- coverage for a variety of environments.
- Half frame

Part #	Crossfire® Model #	Description
19125	2961	Pearl Black Frame w/Smoke Lens
19126	29117	Brown Frame w/HD Brown Mirror Lens
19127	29215	Black Frame w/Indoor/Outdoor Lens

SAFETY



COBRA PROTECTIVE EYEWEAR

Protect your eyes while on patrol in Crossfire® Cobra Protective Eyewear. Exceeding high-impact standards, these glasses boast tough durability and comfort for the law professional on-the-go.

- High-grade Polycarbonate construction.
- Meets and exceeds ANSI Z87+ high-impact specifications.
- Lenses provide 99.9% protection from harmful UVA/UVB rays.
- Comfort fit rubber nosepiece.
- Soft, nonslip rubber temple ends.
- Ultralight frame design for comfortable fit.



Part #	Crossfire® Model #	Description
19110	1541	Black Frame w/Smoke Lens

CORE PROTECTIVE EYEWEAR

Designed with the law professional in mind, these glasses are extremely durable and lightweight.

- Meets and exceeds ANSI Z87.1-2003 high impact standards.
- 99.9% protection from harmful UVA and UVB rays.
- 100% visually correct decentered lenses.
- Rubber nose pads.
- Temple grips.



Part #	Crossfire® Model #	Description
19115	18146	Woodland Brown/Camo Frame w/ HD Brown Mirror Lens

KP6 SAFETY SUNGLASSES

Crossfire® KP6 Safety Sunglasses are stylish enough to wear on or off the job.

- Polycarbonate ¾-frame



Part #	Crossfire® Model #	Description
19130	3441	Black Frame w/Smoke Lens
19131	3469	Black Frame w/Red Mirror Lens
19132	34257	Brown Frame w/Brown Mirror Lens

RPG SAFETY SUNGLASSES

The newly redesigned full frame Crossfire® RPG Safety Glasses make the list once again as one of Crossfire's best selling styles. Fitting a wide range of users,

it is offered in various lens selections for application in diverse environments.

- Full frame



Part #	Crossfire® Model #	Description
19120	23233	Black/Red Frame w/Silver Mirror Lens

Nemesis™

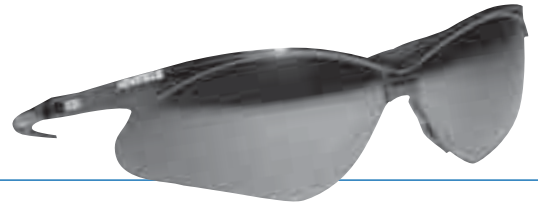

Sleek, sporty style!

Nemesis safety glasses meet ANSI Z87.1+ impact standards and provide 99.9% protection from harmful UV rays.

FogGard® Plus is a permanent lens coating proven to eliminate lens fogging in 99% of workplace applications.

FREE
eyewear cord
included with
every pair!

Part #	Description
19804	Black Frame w/Clear Lens
19805	Black Frame w/Clear FogGard™ Lens
19806	Black Frame w/Smoke Mirror Lens
19807	Black Frame w/Indoor/Outdoor Lens
19808	Black Frame w/Blue Mirror Lens
19809	Black Frame w/Amber Lens
19810	Blue Frame w/Light Blue Lens
19811	Camo Frame w/Bronze Lens
19812	Camo Frame w/Clear Anti-Fog Lens
19814	Camo Frame w/Amber Anti-Fog Lens

Nemesis-VL™



- Frameless ultra-lightweight design, 33% lighter weight than Nemesis.
- No-brow design increases upward and peripheral vision.
- Slip-stop temples designed to prevent slipping and sliding when hot.

Part #	Description
19840	Metal Frame w/Clear Lens
19843	Metal Frame w/Indoor/Outdoor Lens
19844	Metal Frame w/Blue Mirror Lens
19880	Camo Frame w/Copper Lens

Nemesis Rx™



- “Cheaters” style with integral adapters for vision assistance.
- Larger lens for more complete wrap around protection.
- Precise placement of inserts allows for distortion-free forward vision and increased safety when wearing.
- Enhanced nose piece design with integrated ridges to channel away sweat.
- Meets CSA.

Part #	Description
19831	Black Frame w/Clear Readers (1.5)
19832	Black Frame w/Clear Readers (2.0)



Smith & Wesson®

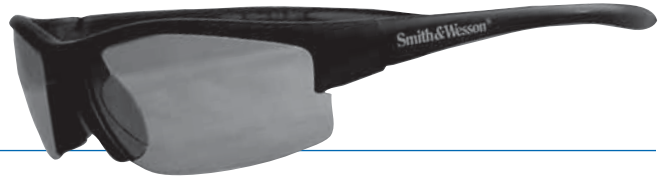

- Soft rubber nose pads for superior comfort and fit.
- Sport grip temples eliminates slippage.
- Wrap-around protection.
- Lens options include anti-scratch or anti-fog coating.
- Complete with micro-fiber carry pouch that doubles as a cleaning cloth.

Part #	Description
19850	Metal Frame w/Smoke Anti-Fog Lens
19852	Blue Frame w/Blue Mirror Lens



- Steamlined, sunglass styling.
- High performance polycarbonate lens.
- Extreme lightweight design.
- Flex point temples for comfort and stability.

Part #	Description
19860	Black Frame w/Smoke Mirror Lens
19862	Black Frame w/Blue Mirror Lens

OTG – OVER THE GLASSES



- Side shields provide added protection.
- Fits over most prescription glasses.
- Comfortable fit for extended wear.

Part #	Description
19870	Black Frame w/Clear FogGard™ Lens
19872	Black Frame w/Smoke Mirror FogGard™ Lens
19874	Black Frame w/Indoor/Outdoor

DISPOSABLE DUST MASKS • GENERAL PURPOSE



Deluxe N95 Respirator

- Meets NIOSH 42 CFR 84 standards at 95% efficiency.
- Valve reduces hot air build up.
- Collapse resistant shell last longer.

Standard Disposable Respirator

- 100% PVC-Free. Dura-Mesh® shell resists collapsing in heat and humidity.
- Molded nose bridge seals easily without a metal noseband.
- Meets heat and flame resistant in accordance with ANSI/ISEA 110-2003 Section 7.11.1



Size	Application Environment	Part #	Pkg Qty
Economy N95 Respirator with Adjustable Metal Nose Piece	Dusty	19602	5
Respirator with Exhale Valve	Hot, Humid, Dusty	19604	10
Respirator with Molded Nose Bridge	Hot, Humid, Dusty	19608	50

“SPARK PLUGS” HEARING PROTECTION • LOW PRESSURE FOAM



- Extra soft, low pressure foam for extra comfort.
- Noise reduction rating (NRR): 31.
- **OSHA Approval Rules:** OSHA approves hearing protection only in accordance with the noise level where it is used.

Description	Part #	Unit Pair/Bag	Box Qty
Uncorded “Spark Plugs”	19610	1	200
Corded “Spark Plugs”	19612	1	100

SAFETY VESTS



- Conforms to MUTCD
- Bound in black cotton binding with elastic side straps and hook and loop front closure.

Description	Part #
Orange Reflective Safety Vest	32065
Dayglow Orange Safety Vest	32066
Class 2 Vest, Med-LG	32067
Class 2 Vest, XL-2X	32068

CHARGER™ HARD HAT • OSHA COMPLIANT HARD HATS

Description	Part #	Unit
White	29430 ★	1
Yellow	29432 ★	1
Blue	29434 ★	1
Green	29436 ★	1
Red	29438 ★	1
Gray	29440 ★	1
Orange	29442 ★	1
Hi Viz Orange	29444 ★	1

- Meets ANSI Z89.1 for impact protection.
- Contoured dome for sleek profile.
- Short cap bill for greater upward vision.
- Antiglare Griptech™ bill limits glare and improves bill grip.
- Constructed for the addition of a 4-point chin strap.
- Lightweight design.



★ Made in USA

BLOCKHEAD HARD HATS

Description	Part #	Unit
White	29410 ★	1
Yellow	29412 ★	1
Red	29418 ★	1
Hi Viz Orange	29424 ★	1

- Meets ANSI Z89.1 + 2003 standards.
- Anti-glare finish under the brim.
- Coolmax® terrycloth sweatband for comfort and easy cleaning.
- Increased thickness on the front and back brim.
- Unique smooth dome design with wide brim.



★ Made in USA

HARD HAT LINERS

Description	Part #	Unit
Full Hard Hat Liner	22329	1
Hard Hat Liner w/Wrap Around Collar	22337	1

- Attaches securely to most popular hard hats.
- Constructed with durable, flame resistant Proban and Nomex.



25 PERSON FIRST AID KIT • MEETS OSHA AND ANSI STANDARDS



- ANSZIZ308.1-2015, OSHA: OSHA 1910.151(B), and Class A-Series 25
- 25 person kit features exclusive compartmental design that holds packets firmly in place.
- Customized to meet the needs of electrical contractor.
- All the benefits of a wall mounted system in a portable box.

Description	Part #	Unit
25 Person Kit	23300	1



10 PERSON FIRST AID KIT • MEETS OSHA AND ANSI STANDARDS



- ANSZIZ308.1-2015, OSHA: OSHA 1910.151(B), and Class A-Series 25
- Compact kit is great for service trucks.

Description	Part #	Unit
10 Person Kit	23298	1





Split Leather Work Glove

Select shoulder split leather. Wing thumb. Rubberized safety cuff.

Size	Part #
L	67600
XL	67601



Unlined Deerskin Drivers Glove

Super soft grain deerskin. Shirred elastic wrist, keystone thumb.

Size	Part #
M	67630
L	67632
XL	67634



Split Leather Drivers Glove

Russet split leather, shirred elastic wrist, keystone thumb.

Size	Part #
M	67609
L	67611
XL	67612



Unlined Grain Pigskin Drivers Glove

Grain pigskin with split pigskin back. Shirred elastic wrist, keystone thumb.

Size	Part #
M	67613
L	67618
XL	67622



Grain Leather Drivers Glove

Top grade grain cowhide leather. Shirred elastic wrist, keystone thumb.

Size	Part #
M	67636
L	67638
XL	67640



1927® Cold Weather Grain Pigskin Glove

Grain pigskin palm, wing thumb, safety cuff. Heatkeep® thermal lining. The same lining used in ski and snowmobile gloves. Pigskin dries soft after getting wet.

Size	Part #
M	67602
L	67604
XL	67608



Lined Brown Jersey Glove

9 oz. brown cotton jersey. Red fleece lining, straight thumb, shirred elastic back.

Size	Part #
L	67648



Unlined Brown Jersey Glove

8 oz. brown cotton jersey. Unlined, knit wrist, straight thumb.

Size	Part #
L	67642



Latex Coated Knit Glove

Gray knitted shell with super gripping blue latex coating.

Size	Part #
M	67650
L	67652
XL	67654



Warm Grip Latex Work Glove

Natural rubber coating for optimal abrasion resistance. Black Mesh. Gray. Form fitted for ergonomic comfort.

Size	Part #
M	67671
L	67672



Frostbreaker® Thermal Latex Gripping Glove

Black acrylic knit shell, knit wrist, dipped gray color latex palm and fingers.

Size	Part #
M	67663
L	67664
XL	67665



White String Knit Glove

Medium weight polyester/cotton knit with elasticized wrist.

Size	Part #
L	67658



Nitrile Palm Coated Glove

Navy blue nylon knit shell, gray color smooth finish nitrile coated palm and fingers.

Size	Part #
S	67509
M	67510
L	67511
XL	67512



Fingerless Ragg Wool Glove

85% Wool/15% Nylon Ragg Wool for maximum warmth. Fingerless for dexterity on intricate jobs.

Size	Part #
L	67595



Kevlar® Lined Glove

Kevlar® lined, cut-resistant, durable, non-slip reinforcement palm. Black Mesh. Gray.

Size	Part #
M	67624
L	67625
XL	67626



White Canvas Glove

8 oz. white canvas. Knit wrist for snug fit.

Size	Part #
L	67661



PVC Dipped Glove

Black PVC over cotton lining. Suggested for most oils, acids, caustics, alcohols and solvents. Use with care. 12" long.

Size	Part #
L	67662

See page 273 for our Glove Display offers!



Pro-Grip Full Finger Glove

PVC Reinforced palm, thick stretch nylon between fingers. Full finger for extra protection. Black.

Size	Part #
M	67561
L	67563
XL	67565



Pro-Grip Half Finger Glove

PVC reinforced palm, thick stretch nylon between fingers. Gray Mesh. Half fingered for extra dexterity. Black.

Size	Part #
M	67551
L	67553
XL	67555



Pro-Grip Winter Plus Glove

100% waterproof and windproof. Triple layer insulating system. Keeps hands warm and dry. Black.

Size	Part #
M	67579
L	67581
XL	67583
XXL	67584
M	67579CAMO
L	67581CAMO
XL	67583CAMO



Pro-Grip Mechanic's Plus Glove

Water and oil resistant synthetic suede palm. Incredible dexterity. Internal knuckle protection. Terry cloth brow wipe on thumb. Blue.

Size	Part #
M	67567
L	67569
XL	67571



Pro-Grip Mesh General Utility Glove

Designed for warm temperatures. Breathable gray mesh. Non-slip reinforced palm, finger and thumb. Black.

Size	Part #
M	67573
L	67575
XL	67577

ROOF JACKS (FLASHINGS)

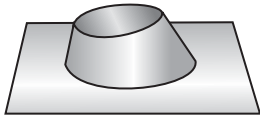

Description	Part #	Unit	Std Pack
1/2" Standard Roof Jacks	95000	1	12
3/4" Standard Roof Jacks	95002	1	12
1" Standard Roof Jacks	95004	1	12
1 1/4" Standard Roof Jacks	95006	1	24
1 1/2" Standard Roof Jacks	95008	1	24
2" Standard Roof Jacks	95010	1	24
3" Standard Roof Jacks Bath Vent	95012	1	12
4" Standard Roof Jacks Bath Vent	95014	1	12

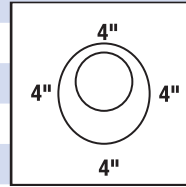

Save 10% for ordering standard pack.

SERVICE ENTRANCE CAPS



- Clamp-on
- Aluminum
- For Rigid, IMC, and EMT

Description	Part #	Std Pack
1/2" Service Entrance Cap	95120	10
3/4" Service Entrance Cap	95122	5
1" Service Entrance Cap	95124	5
1 1/4" Service Entrance Cap	95126	5
1 1/2" Service Entrance Cap	95128	5
2" Service Entrance Cap	95130	1
2 1/2" Service Entrance Cap	95132	1
3" Service Entrance Cap	95134	1
3 1/2" Service Entrance Cap	95136	1
4" Service Entrance Cap	95138	1

MISCELLANEOUS

PRE-KUTS PLASTIC SLEEPERS



- Plastic Pre-Kuts will outlast any wood or foam sleeper.
- Lightweight, easier to haul than wood sleepers.
- No special clamps needed.
- Most economical solution for this application.
- 4 1/4" x 9" x 1 1/2"
- Clamshell.

Description	Part #	Pkg Qty
Pre-Kuts	96160 ★	10

★ Made in USA

See Minerallac pages 196-199 for One Hole Straps.

CABLE TENSIONING TOOL & CABLE TIE KITS

- Black cable ties are UV rated.

Description	Part #
Cable Tie Tensioning Tool	22298 ★



Kits

Part #	Description
22290 ★ (400 Piece Kit)	Natural 4"–18lb (200 Pieces) 7"–50lb (100 Pieces) 11"–50lb (100 Pieces)
22292 ★ (400 Piece Kit)	Black 4"–18lb (200 Pieces) 7"–50lb (100 Pieces) 11"–50lb (100 Pieces)
22294 ★ (401 Piece Kit)	Natural 4"–18lb (200 Pieces) 7"–50lb (100 Pieces) 11"–50lb (100 Pieces) Includes Tensioning Tool Part #22298
22296 ★ (401 Piece Kit)	Black 4"–18lb (200 Pieces) 7"–50lb (100 Pieces) 11"–50lb (100 Pieces) Includes Tensioning Tool Part #22298

★ Made in USA

MOUNTING BASES • ADHESIVE-BACKED/PUNCH-OUT SCREW HOLE

- Four-sided design, adhesive backing and punch-through screw hole provide virtually unlimited

options for attaching and holding.

- Black mounting bases are UV rated.



Length	Color	Part #	Bag Qty
3/4	Natural	22280 ★	100
3/4	Black	22282 ★	100
1	Natural	22284 ★	100
1	Black	22286 ★	100

★ Made in USA

PLASTIC CABLE TIE FASTENER

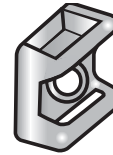

PCTF

- For securing data/com cables.
- Supports cable ties up to 5/16" in width.
- Secures directly to wall.

Part #	Std Qty
PCTF ★	100

★ Made in USA

CABLE TIES



- Tensile strength exceeds industry standards to give you the holding power you need.
- Black cable ties are UV rated.

Length	Color	Tensile Strength (lbs)	Min/Max Bundle Diameter	Part #	Bag Qty
4	Natural	18	1/16-1/8	22200 ★	100
4	Black	18	1/16-1/8	22202 ★	100
5	Natural	40	1/16-1 7/16	22204 ★	100
5	Black	40	1/16-1 7/16	22206 ★	100
7	Natural	50	1/16-1 7/8	22208 ★	100
7	Black	50	1/16-1 7/8	22210 ★	100
8	Natural	40	1/16-2 3/8	22212 ★	100
8	Black	40	1/16-2 3/8	22214 ★	100
11	Natural	50	1/16-3 1/16	22216 ★	100
11	Black	50	1/16-3 1/16	22218 ★	100
14	Natural	50	1/16-4 1/8	22220 ★	100
14	Black	50	1/16-4 1/8	22222 ★	100
14	Natural	120	3/16-4 1/16	22224 ★	100
14	Black	120	3/16-4 1/16	22226 ★	100
36	Natural	175	3/16-11	22228 ★	50
36	Black	175	3/16-11	22230 ★	50

★ Made in USA

MOUNTING TIES



- Screws into wood or metal for simple, secure cable bundling.
- Black mounting ties are UV rated.

Length	Color	Tensile Strength (lbs)	Min/Max Bundle Diameter	Part #	Bag Qty
7	Natural	50	1/16-1 3/4	22240 ★	100
7	Black	50	1/16-1 3/4	22244 ★	100
11	Natural	50	1/16-3 1/16	22254 ★	100
11	Black	50	1/16-3 1/16	22256 ★	100
14	Natural	50	1/16-4	22258 ★	100
14	Black	50	1/16-4	22260 ★	100
14	Natural	120	3/16-4	22262 ★	100
14	Black	120	3/16-4	22264 ★	100

★ Made in USA

WALL PLATE INSULATING GASKETS • FOAM THERMAL BARRIER

- Universal design fits all standard and decora-style toggle/duplex receptacles.
- Excellent thermal barrier prevents heat loss and reduces drafts through outlets and switches.
- Foam is rated #94HF1.

Description	Part #	Box Qty
Insulating Gasket	80014 ★	100

★ Made in USA

Installation: Insert one foam gasket in each outlet or switch box on perimeter walls.

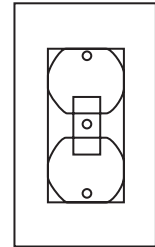

REDUCING WASHERS • ZINC PLATED

Size	Part #	Qty
3/4 x 1/2	33400	100
1 x 1/2	33402	100
1 x 3/4	33404	100
1 1/4 x 1/2	33406	50
1 1/4 x 3/4	33408	50
1 1/4 x 1	33410	50
1 1/2 x 1/2	33412	50
1 1/2 x 3/4	33414	50
1 1/2 x 1	33416	50
1 1/2 x 1 1/4	33418	50
2 x 1/2	33420	25
2 x 3/4	33422	25
2 x 1	33424	25
2 x 1 1/4	33426	25
2 x 1 1/2	33428	25

Size	Part #	Qty
2 1/2 x 1	33430	25
2 1/2 x 1 1/4	33432	25
2 1/2 x 1 1/2	33434	25
2 1/2 x 2	33436	25
3 x 1	33438	10
3 x 1 1/4	33439	10
3 x 1 1/2	33440	10
3 x 2	33441	10
3 x 2 1/2	33443	10
3 1/2 x 1 1/2	33442	10
3 1/2 x 2	33444	10
3 1/2 x 2 1/2	33446	10
3 1/2 x 3	33448	10
4 x 2	33450	10
4 x 2 1/2	33452	10
4 x 3	33454	10
4 x 3 1/2	33456	10

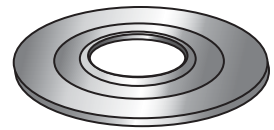

REDUCING BUSHINGS • ZINC PLATED

Size	Part #	Qty
1/2 x 3/8	67450	100
3/4 x 1/2	67452	100
1 x 1/2	67454	50
1 x 3/4	67456	50
1 1/4 x 1/2	67458	25
1 1/4 x 3/4	67460	25
1 1/4 x 1	67462	25
1 1/2 x 1/2	67464	25
1 1/2 x 3/4	67466	25
1 1/2 x 1	67468	25
1 1/2 x 1 1/4	67470	25

Size	Part #	Qty
2 x 1/2	67472	10
2 x 3/4	67474	10
2 x 1	67476	10
2 x 1 1/4	67478	10
2 x 1 1/2	67480	10
3 x 2	67484	1
3 x 2 1/2	67486	1
3 1/2 x 2	67488	1
3 1/2 x 2 1/2	67490	1
3 1/2 x 3	67492	1
4 x 2	67494	1
4 x 2 1/2	67496	1
4 x 3	67498	1
4 x 3 1/2	67499	1

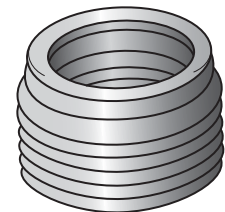

MISCELLANEOUS

CEILING COVER PLATE • ADJUSTABLE

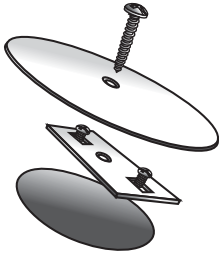

- Includes canopy, adjustable strap and machine screws.
- White metal plate adjusts to fit 3" and 4" outlet boxes.
- Useful for temporary and permanent applications.

Description	Part #	Std Pkg
5¼" White Canopy	90010	1/25

SNAP-IN KNOCK-OUT SEALS • ZINC-PLATED

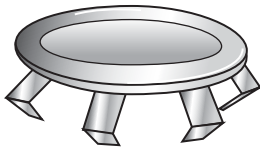

- Snap-in design for quick and easy installation.

Size	Part #	Box Qty
½	90020	100
¾	90024	100
1	90028	100

Size	Part #	Box Qty
1¼	90032	50
1½	90036	50
2	90040	25

3-PIECE KNOCK-OUT SEALS • ZINC-PLATED/GALVANIZED

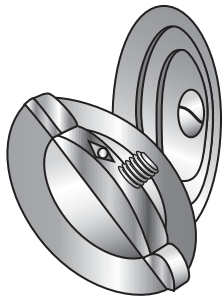

- Size is stamped on seal.

Size	Part #	Box Qty
½	90050*	100
¾	90052*	50
1	90054*	25
1¼	90056*	25
1½	90058*	10
2	90060*	10
2½	90062*	10

Size	Part #	Box Qty
3	90064*	10
3½	90066	10
4	90068	10
5	90072	10
6	90074	10

*Comes assembled.

NON-METALLIC KNOCK-OUT SEALS



- Easy Snap in installation – No Conductivity possible.
- Tight tolerances = snug fit in different panels/boxes.
- Fits all metallic and non-metallic material from ½" to 1⅛".
- Easy installation in tight space areas.
- UL and CSA approved.
- VO fire rated.

Description	Hang Tag Bag	
	Part #	Std Pkg
½" Knock Out Non-Metallic	K050	50
¾" Knock Out Non-Metallic	K075	50
1" Knock Out Non-Metallic	K0100	25
1¼" Knock Out Non-Metallic	K0125	25
1½" Knock Out Non-Metallic	K0150	25
2" Knock Out Non-Metallic	K0200	25
Assortment Knock Out Non-Metallic	KOSORT	1

WIRE & CABLE MARKER BOOKS

Cully Wire and Cable Marker Books are manufactured with high quality vinyl cloth, but are finished with an economical flat stitch for users who don't require removable pages. The book system is convenient and fits into your pocket for travel to the job.

They are mounted on 90# super release lay flat liner. The slick surface protects the adhesive until used. This assures full bonding power when applied to a wire.

Each book contains 450 wire markers and 450 matching terminal strips. Wire and cable markers are printed on impregnated cloth, the proven general purpose material for maintenance, construction and product identification.



MISCELLANEOUS

		 Hang Tag Bag
Markers	Legend	Part # Qty
Wire & Cable	0 (45 each) 1-45 (10 each)	CULWM045 ★ 1
Wire & Cable	0-9 (45 each)	CULWM09 ★ 1
Wire & Cable	0-9 (45 each) L1, L2, L3, T1, T2, T3 (15 each)	CULWM09LT ★ 1
Wire & Cable	1, 2, 3 (150 each)	CULWM123 ★ 1
Wire & Cable	1-30 (15 each)	CULWM130 ★ 1
Wire & Cable	1-90 (5 each)	CULWM190 ★ 1
Wire & Cable	-, /, +, A-Z (2 each) 0-15 (6 each) 16-90 (4 each)	CULWM190AZ ★ 1
Wire & Cable	46-90 (10 each)	CULWM4690 ★ 1
Wire & Cable	A, B, C (150 each)	CULWMABC ★ 1
Wire & Cable	- (7 each) + (8 each) A-Z (15 each) BLANK (21 each)	CULWMAZ ★ 1
Wire & Cable	-, /, +, 0-15, A-Z (10 each)	CULWMAZ015 ★ 1
Wire & Cable	1, 2, 3, A, B, C (45 each) L1, L2, L3, T1, T2, T3 (30 each)	CULWMINST ★ 1
Wire & Cable	L1, L2, L3 (150 each)	CULWML1 ★ 1
Wire & Cable	T1, T2, T3 (150 each)	CULWMT1 ★ 1

★ Made in USA

Continued on next page.

WIRE & CABLE MARKER BOOKS (CONT.)

		Hang Tag Bag	
Markers	Legend	Part #	Qty
Wire & Cable	10 NEMA Colors (45 each)	CULWMNEMA ★	1
Wire & Cable	Air Cond 1, Air Cond 2, Compactor, Dishwasher, Disposal, Driveway Lights, Dryer, Entertainment Center, Entry Lights, Freezer, Heating 1, Heating 2, Main, Outside Lights, Pool, Pool Heater, Range, Refrigerator, Security System, Shed, Sump Pump, Vent System, Washer, Water Heater 1, Water Heater 2, Water Pump, Whirlpool, Whirlpool Heater (5 each) Attic, Basement, Bath 1, Bath 2, Bedroom 1, Bedroom 2, Bedroom 3, Bedroom 4, Blank, Den, Dining Room, Family Room, Garage, Living Room, Master Bath, Patio, Rec Room, Smoke Detector, Sunroom, Utility Room (10 each) Kitchen, Master Bedroom (15 each) GFCI (20 each) Lights, Outlets (30 each)	CULWMRC ★	1
Wire & Cable	BLANK, NEUT, SPARE (21 each) GND, NEG, POS (33 each) -, +, AC, DC (45 each)	CULWMVOLT ★	1
Burglar/Security	1-30 (3 each) 1-45 (1 each) AC AC/AC AC (6 each) Annunciator, BA/BA, Feed/Feed, Fire/Fire, Ground, Phone Feed, Phone Return, Return/Return, Siren/Bell, Smoke Detector, Temperir Tamper, Thermostat (9 each) +Circuit+, -Circuit- (12 each) GB/GB, Keypads, PIR/PIR (15 each) AC Transformer (27 each) Blank (45 each) Zone/Zone (60 each)	CULWMBA ★	1
Fire/Security	1-15, 16-30 (3 each) 1-45 (1 each) AC AC/AC AC (6 each) Annunciator, Siren/Bell, Tamper (9 each) +Circuit+, -Circuit- (12 each) GB/GB, Keypads, PIR/PIR (15 each) Duct Detector, Heat Detector, Horn/Horn, Horn/Strobe, Smoke Detector, Strobe/Strobe (18 each) BLANK (45 each) Zone/Zone (60 each)	CULWMFA ★	1

MISCELLANEOUS

★ Made in USA



Minerallac[®]
Traditional

Black Claw[™]

IMPACT[®]
STAPLES

REDMORE[®]

PICTORIAL INDEX

LOAD RATING

Minerallac fasteners are designed with two load limits:

Static Load Limit is a rated stationary load limit. The listed static load limit has a safety factor of three.

Ultimate Static Load Limit is the rated stationary load limit which, if exceeded, may cause failure of the fastener.

Load limits are for loads applied VERTICALLY except as may be diagrammed otherwise. The load capacity of a fastener having more than one component is equal to the load capacity of the lowest rated component.

MATERIALS

Steel

We specify commercial quality (CQ) hot rolled pickled and oil (HRPO) or cold rolled (CR) steel for our parts where a specific material specification is not needed.

Spring Steel

We specify a high carbon, cold rolled, annealed, spring steel for all Black Claw™ products.

Stainless Steel

We specify 304 stainless steel for all our stocked products. However, other grades are available but minimum quantities may apply.

Aluminum

We specify 3003-H14 on all aluminum products unless otherwise specified.

Brass

We specify a 70/30 brass C260 1/4 hard material for all our stock products. Formerly named as Everdur® in past catalogs.

COATINGS

Pre-Galvanized Zinc

This coating of zinc is applied directly at the mills by rolling the material through molten zinc. Parts fabricated from this material have exposed edges where the material has been cut; but the zinc near the uncoated metal becomes a sacrificial anode to protect the bare areas for a short period of time. These parts are recommended for indoor use in dry areas.

Zinc Plated or Electro-Galvanized

We have our parts plated after fabrication to commercial quality standards, and recommend them for indoor, relatively dry environments. Zinc plating is the process by which a coating of zinc is deposited on the steel by electrolysis from a bath of zinc salts. The zinc coating thickness for commercial quality is approximately 0.00015–0.00020 inches.

Hot Dipped Galvanized

We submerge our parts after fabrication into a molten bath of zinc thus coating all the edges of the parts. Hot Dipped Galvanized to ASTM A123 specifications. Parts are recommended for indoor/outdoor use and mildly corrosive environments.

Zinc Phosphate and Oil

We have most of our high carbon spring steel parts (Black Claw™) coated with this process after fabrication and heat-treating. The process applies a base of crystalline zinc phosphate of 1000 milligrams a square foot and then a synthetic organic corrosion inhibitor with a particular affinity for zinc compounds. These parts are recommended for indoor, non-corrosive environments.

Copper Plated

We specify a commercial grade finish on all stock copper plated parts.

WARRANTY

Minerallac warrants all products sold to be free and clear of all liens and encumbrances and to be free from defects in material and workmanship. In the event that any product fails to conform to such warranty, Minerallac's liability is limited solely to replacing such product without charge.

The warranties set forth above are exclusive and are in lieu of all other warranties whether statutory, expressed, or implied including warranties of merchantability and fitness for a

particular purpose, and warranties arising from course of dealing or usage of trade. The above provides remedy of replacement will be the sole and exclusive remedy of any purchaser of a product for any failure by Minerallac to comply with the warranty provision, whether claims by purchaser are based on contract or in tort including negligence, and in no event shall Minerallac be liable for loss of profits, indirect, special, consequential and other similar damages, and any economic loss resulting from any such failures.

Contact Customer Service for Minerallac Terms and Conditions of Sale, return policy and freight allowance.

CONDUIT/CABLE/WIRE



Conduit Hangers
pages 193–194



One-Hole Straps • Jiffy Clip®
pages 195–198



One-Hole Duplex • Jiffy Clip®
page 199



Slotted Duplex • Jiffy Clip®
page 199



Conduit Strap • Two-Hole Metal
pages 200–201



Multi-Use Two-Hole Plastic Straps
page 201



Multi-Purpose Closed Clip
page 201



Service Entrance Straps • One-Hole
page 202



Service Entrance Straps • Two-Hole
page 203

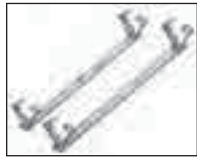

Conduit & Box Support Fasteners
page 204



Conduit & Box Support Assembly
page 205



Ground Wire Clip
page 206

PICTORIAL INDEX

NAIL STRAPS

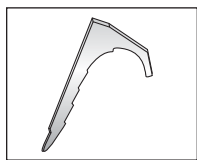

Nail Straps
page 207

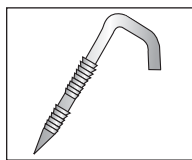

Round Nail Straps
page 207

BEAMS



Beam Clamps • Universal
page 208



Beam Clamps • Malleable
page 208



Beam Clamp Assemblies
page 209



Flange/T-Bar Clip
page 209



Beam Mount Conduit & Box Support Assembly
page 210

METAL STUD & DRYWALL



Box Mounting Bracket
page 211



Box to Bar Fastener
page 211



Outlet Retainer
page 212



Box Mounting Bracket
page 212



Box Stabilizer Support
page 213



Box Supports • Screwless Design
page 213

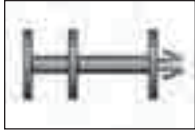

Plastic Far Side Box Support
page 214

ACOUSTICAL



Box to T-Bar Fastener
page 214



Lighting Support Assembly
page 214



T-Bar Hanger
page 215



T-Bar Scissor Clips
page 215



T-Bar Drop Wire Clip
page 215

VOICE/DATA & LOW VOLTAGE



Cable Support • J Hooks
page 216



Cable Support • Bridle Rings
pages 217–218



Universal Metal Stud Grommet
page 218



Cable Protection • Nail Plates
page 219



Cable Support • D-Rings
page 220



Low Voltage Mounting Bracket
page 220

HARDWARE/ACCESSORIES



Stove Bolt with Nut
page 221



Wing Nut Washer
page 221



Perforated Strapping
page 222



Stud Clip Adapter
page 222



Brackets
page 223



Bar Joist Washers
page 223

CONDUIT CABLE



Conduit Clip
page 225



Conduit to Conduit Trapeze Assembly
page 226



Cable Clip
page 227



Conduit Clip
page 227



Multi-Function Clip
page 228



Multi-Function Clip Assemblies
page 228



Flexible Conduit/ Cable Clip
page 229



Flange Mount Conduit Clip Assembly
pages 230–231

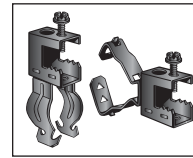

Beam Clamp to Conduit Hanger Assemblies
page 236

HANGERS



Rod/Wire • Bracket Support
page 232



Rod/Wire Beam Assemblies
page 233



Threaded Rod to Beam Assemblies
page 233



Strap Hangers
page 234

BEAM/PURLIN



Beam Clamps
page 235



Flange Beam Clamp
page 237



Z Purlin Hanger
page 237

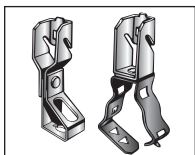

Z Purlin Hanger Assemblies
pages 238–239



Z Purlin Flange Hanger
page 239



Flange Hanger
page 240

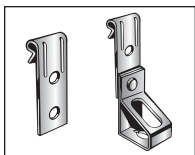

Rod to Flange Hanger
page 240

METAL STUD



Conduit/Cable Support
page 241

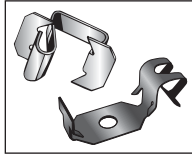

Flexible Conduit/Cable Fastener
page 241



Conduit to Stud Support
page 242



Box To Stud Fastener
page 242



Box To Stud Support
page 243



Conduit to Stud Fastener
page 244

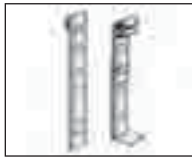

Far Side Box Support
page 244

ACOUSTICAL



Lighting • Troffer Fastener
page 245



Twist on T-Bar Hanger
page 245



T-Bar Fasteners
pages 246–247

VOICE/DATA & LOW VOLTAGE

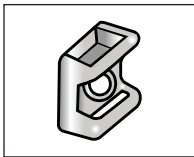

Plastic Cable Tie Fastener
pages 179 & 248

HARDWARE/ACCESSORIES



Box To Bar Fastener
page 249



Rod Hangers
page 249

NON-INSULATED METAL STAPLES

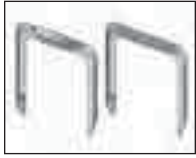

Cable Staples
page 254

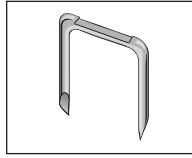

Service Entrance Staples
page 254

INSULATED METAL STAPLES



Plastic Insulator Cable Staples
page 255



PVC Dipped Cable Staples
page 255

INSULATED PLASTIC STAPLES



Plastic Cable Staples
page 256



Stacking Cable Staples
page 256



Service Entrance Staples • Style SER
page 257



Service Entrance Staples • Style SEU
page 257



Bell & Thermostat Staples
page 257



Non-Metallic Sheathed Cable Staples
page 257

DIAMOND POINT STAPLES

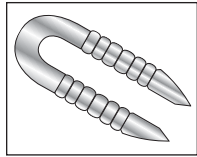

Square Wire Barbed Staples
page 260

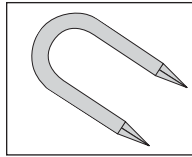

Bright Wire Diamond Point Staples
pages 261–262

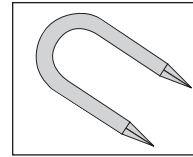

Electro-Zinc Diamond Point Staples
page 262

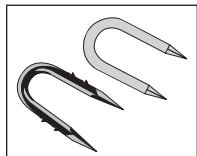

Galvanized Diamond Point Staples
page 263

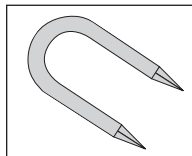

Copperclad Diamond Point Staples
page 263



Drive Stop® Diamond Point Staples
page 264

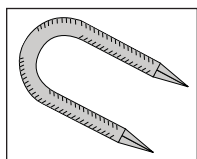

Serrated Electro-Zinc Diamond Point Staples
page 264

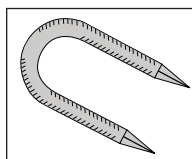

Serrated Galvanized Diamond Point Staples
page 264

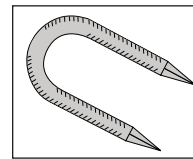

Electro-Zinc Flat Top Diamond Point Staples
page 264

CUT POINT STAPLES



Pre-Galvanized Cut Point Staples
page 265



Galvanized Cut Point Staples
page 266



Copperclad Cut Point Staples
page 266

NAILS



Galvanized Roofing Nails
page 267



Galvanized Marking Nails
page 267



Galvanized & Copperclad Common Nails
pages 267–268

Minerallac[®]

Traditional

Quality That Saves You Time

For over a hundred years, Minerallac has provided the electrical contractor with time-saving and innovative fasteners. Our "Traditional" line has expanded from the conduit hanger and one-hole "Min-E"® strap, invented and patented by Minerallac, to well over a thousand different sizes, styles and finishes of electrical fasteners from which to choose. We're sure to have the fastener, style, finish and quality you require. That's the Minerallac Advantage!

193-206 Conduit/Cable/Wire

207 Nail Straps

208-210 Beams

211-214 Metal Stud & Drywall

214-215 Acoustical

216-220 Voice/Data & Low Voltage

221-223 Hardware/Accessories



CONDUIT HANGERS

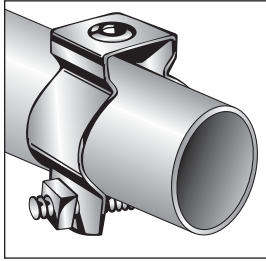

9SB



OB

- Our standard conduit hangers come zinc-plated or made from 304 stainless steel.
- Available with or without bolt and nut attached.
- The original conduit hanger available for 1/2" through 5" conduit.

Available made from aluminum, brass or steel that has been hot dip galvanized or copper-plated. Call customer service for pricing and minimum order quantities.

See page 74 or 213 to order bolts and nuts separately.

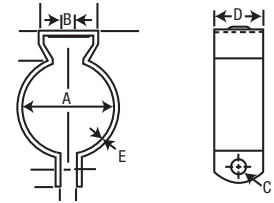

Fits Rigid/IMC	Fits EMT	Nom. Pipe O.D. A	B	C	D	E	W/O Bolt Attached Part #	With Bolt Attached Part #	Std Pkg
Zinc Plated									
3/8-1/2	1/2	0.675-0.840	1/4	1/4	.750	.050	0 ★	0B*	100
3/4	3/4	0.922-1.050	1/4	1/4	.875	.050	1 ★	1B*	100
1	1	1.163-1.315	1/4	1/4	.875	.050	2 ★	2B*	100
—	1 1/4	1.510	1/4	1/4	.875	.050	2 1/2 ★	2 1/2 B*	100
1 1/4	1 1/2	1.660-1.740	1/4	1/4	.875	.050	3 ★	3B*	100
1 1/2	—	1.883-1.900	5/16	1/4	1.000	.060	4 ★	4B*	100
2	2	2.197-2.375	5/16	1/4	1.250	.060	5 ★	5B*	50
2 1/2	2 1/2	2.857-2.875	5/16	1/4	1.250	.060	6 ★	6B*	50
3	3	3.476-3.500	5/16	5/16	1.250	.060	7 ★	7B*	25
3 1/2	3 1/2	3.971-4.000	5/16	5/16	1.250	.060	8 ★	8B*	25
4	4	4.466-4.500	1/2	1/2	1.750	.080	9 ★	9B*	10
5	—	5.563	1/2	1/2	1.750	.080	10 ★	10B*	10

* Made in USA per Federal Trade Commission 1998

★ Made in USA

CONDUIT HANGERS (CONT.)

Fits Rigid/IMC	Fits EMT	Nom. Pipe O.D. A	B	C	D	E	W/O Bolt Attached Part #	With Bolt Attached Part #	Std Pkg
Stainless Steel (Type 304)									
3/8-1/2	1/2	0.675-0.840	1/4	1/4	.750	.050	0S ★ ♡	0SB* ♡	100
3/4	3/4	0.922-1.050	1/4	1/4	.875	.050	1S ★ ♡	1SB* ♡	100
1	1	1.163-1.315	1/4	1/4	.875	.050	2S ★ ♡	2SB* ♡	100
—	1 1/4	1.510	1/4	1/4	.875	.050	2 1/2S ★ ♡	2 1/2SB* ♡	100
1 1/4	1 1/2	1.660-1.740	1/4	1/4	.875	.050	3S ★ ♡	3SB* ♡	100
1 1/2	—	1.883-1.900	5/16	1/4	1.000	.060	4S ★ ♡	4SB* ♡	100
2	2	2.197-2.375	5/16	1/4	1.250	.060	5S ★ ♡	5SB* ♡	50
2 1/2	2 1/2	2.857-2.875	5/16	1/4	1.250	.060	6S ★ ♡	6SB* ♡	50
3	3	3.476-3.500	5/16	5/16	1.250	.060	7S ★ ♡	7SB* ♡	25
3 1/2	3 1/2	3.971-4.000	5/16	5/16	1.250	.060	8S ★ ♡	8SB* ♡	25
4	4	4.466-4.500	1/2	1/2	1.750	.080	9S ★ ♡	9SB* ♡	10

* Made in USA per Federal Trade Commission 1998

★ Made in USA

♡ Harsh Environment Product

- Modeled after Minerallac's Standard Conduit Hangers, the K Series incorporates value and ease of use.
- Parts come with bolts only. Keyhole design eliminates need for nut.
- Made from pre-galvanized steel.

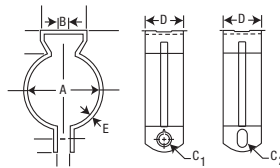

Our Most Economical Conduit Hanger - NO NUT NEEDED!

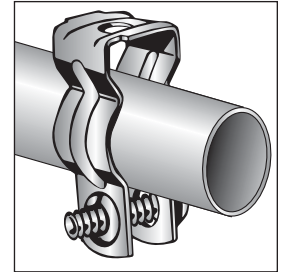

Fits Rigid/IMC	Fits EMT	Thread Imp					Part #	Std Pkg
		A	B	C ₁	C ₂	D		
Pre-Galvanized								
3/8-1/2	1/2	0.675-0.840	1/4	1/4-20	1/4 X 3/8	.625	.040	K0B ★ 100
3/4	3/4	0.922-1.050	1/4	1/4-20	1/4 X 3/8	.750	.040	K1B ★ 100
1	1	1.163-1.315	1/4	1/4-20	1/4 X 3/8	.750	.040	K2B ★ 100

* Made in USA per Federal Trade Commission 1998



MINERALLAC TRADITIONAL

ONE-HOLE STRAP • JIFFY CLIP®

Minerallac has the widest variety of one-hole straps in the industry. If you can't find it at Minerallac, it probably doesn't exist.

Minerallac manufactures five grades of one-hole straps to fit any budget, any application. And many of our one-hole straps are available in other materials, and finishes—stainless steel, brass, copper-plated steel or hot dip galvanized steel.

From our most economical K-series one-hole straps to our best quality heavy-duty one-hole straps, you can't find a wider selection or better value anywhere.

THE ORIGINAL JIFFY CLIP®!

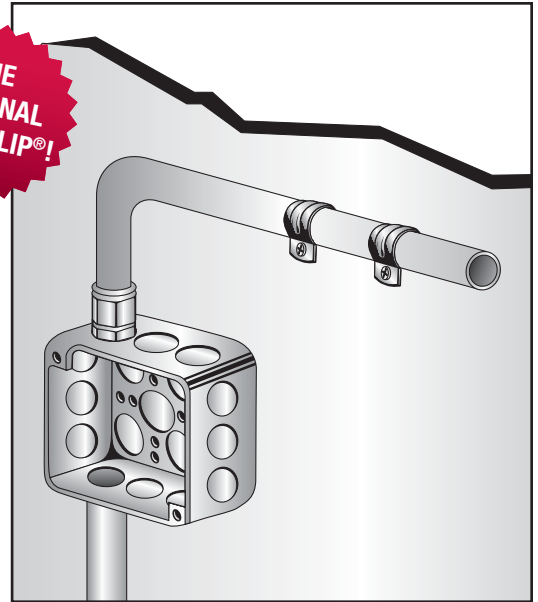

One-Hole Jiffy Clips® in Five Grades

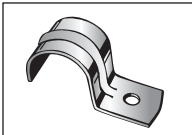

K-Series
Most Economical



"Standard" Series
The "original" Jiffy Clip®

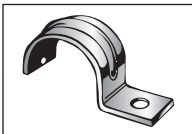

"Min-E" Series
Most Value



"Medium" Series
Most Popular



"Heavy Duty" Series
Strongest

K-Series

- Precision made one-hole pipe straps with snap-on feature.
- Pre-galvanized steel.



Our most economical Jiffy Clip®!

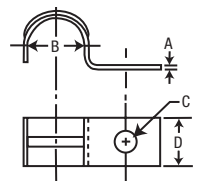

Fits EMT	Nom. Pipe O.D.				Part #	Std Pkg
	A	B	C	D		
Pre-Galvanized						
½	.050	0.706	¼	0.625	K30 ★	100
¾	.050	0.922	¼	0.625	K45 ★	100
1	.050	1.163	¼	0.875	K55 ★	100

★ Made in USA

ONE-HOLE STRAP • JIFFY CLIP®

STANDARD Series

- These one-hole pipe straps are ideal for hanging tubing, pipe, conduit and BX cable.
- Pre-galvanized steel, except for items 135, 165, 160, and 170 which are zinc plated.
- Parts also available in copper plated or made from brass. Call customer service for pricing and minimum order quantities.

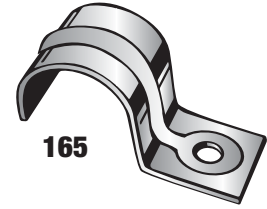
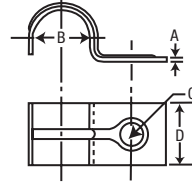

Fits Tubing O.D.	Fits Rigid	Fits EMT	Marking On Clip	A	Nom. O.D. B	Bolt C	D	No. Ribs	Part #	Std Pkg
Pre-Galvanized										
1/8	—	—	—	.035	0.125	3/16	.500	1	102 ★	100
3/16	—	—	—	.035	0.1875	3/16	.500	1	103 ★	100
1/4	—	—	—	.035	0.250	3/16	.500	1	105 ★	100
5/16	—	—	—	.035	0.3125	3/16	.500	1	110 ★	100
3/8	—	—	115	.045	0.375	3/16	.625	1	115 ★	100
—	1/8	—	120	.045	0.405	3/16	.625	1	120 ★	100
—	BX: 14-2, 14-3, 12-2	—	121	.045	0.475	3/16	.625	1	121 ★	100
1/2	1/4 & BX: 12-3, 10-2, 10-3	—	125	.045	0.540	3/16	.625	1	125 ★	100
—	3/8	1/2	130	.050	0.675–0.706	1/4	.750	1	130 ★	100
3/4	—	—	750	.050	0.750	1/4	.750	1	135* ★	100
—	1/2	—	140	.050	0.840	1/4	.875	1	140 ★	100
—	—	3/4	145	.050	0.922	1/4	.875	1	145 ★	100
1	3/4	—	150	.050	1.000–1.050	1/4	.875	1	150 ★	100
—	—	1	155	.050	1.163	1/4	.875	1	155 ★	100
—	1	—	1"	.060	1.315	1/4	1.000	2	160* ★	100
1 1/2	—	1 1/4	1 1/4"	.060	1.500–1.510	1/4	1.000	2	165* ★	100
—	1 1/4	1 1/2	1 1/4"	.060	1.660–1.740	5/16	1.250	2	170* ★	100

*Zinc plated

★ Made in USA

MINERALLAC TRADITIONAL

ONE-HOLE STRAP • JIFFY CLIP®

MIN-E® Series

- MinE® clips have an inverted rib providing more strength at the bend of the clip. Snap-on feature leaves both hands free to work.
- Pre-galvanized steel, except for items MINE55, MINE40, and MINE50, which are zinc plated.

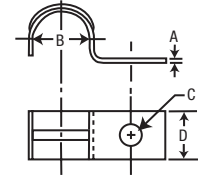

Fits EMT	A	Nom. Pipe O.D. B	Bolt C	D	Part #	Std Pkg
Pre-Galvanized						
1/2	.074	0.706	1/4	.625	MINE30 ★	100
3/4	.074	0.922	1/4	.625	MINE45 ★	100
1	.090	1.163	1/4	.750	MINE55* ★	100

*Zinc plated
★ Made in USA

Fits Rigid	Flexible Conduit	A	Nom. Pipe O.D. B	Bolt C	D	Part #	Std Pkg
Pre-Galvanized							
—	3/8	.074	0.560	1/4	.625	MINE28 ★	100
1/2	1/2	.090	0.840	1/4	.750	MINE40* ★	100
3/4	3/4	.090	1.050	1/4	.750	MINE50* ★	100

*Zinc plated
★ Made in USA

MEDIUM Series

- Our best-selling precision made one-hole conduit and pipe straps.
- Clips have an inverted rib providing more strength at the bend of the clip and holding the clip on the conduit, leaving both hands free to work.
- Both zinc plated steel and stainless steel medium Jiffy Clips® are available.
- Also available hot-dip galvanized steel. Call customer service for pricing and minimum order quantities.

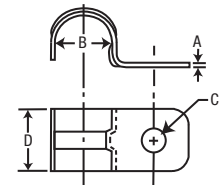
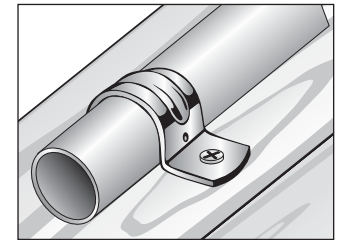

Fits EMT	Fits Rigid & IMC	A	Nom. Pipe O.D. B	Bolt C	D	Part #	Std Pkg
Zinc Plated							
1/2	—	.080	0.706	1/4	.875	MED30 ★	100
—	1/2	.080	0.840	1/4	.875	MED40 ★	100
3/4	—	.080	0.922	1/4	.875	MED45 ★	100
—	3/4	.080	1.050	1/4	.875	MED50 ★	100
1	—	.080	1.163	1/4	.875	MED55 ★	100
—	1	.080	1.315	1/4	.875	MED60 ★	100
1 1/4	—	.090	1.510	5/16	1.000	MED65 ★	100
—	1 1/4	.090	1.660	5/16	1.000	MED70 ★	100
1 1/2	—	.090	1.740	5/16	1.000	MED75 ★	50
—	1 1/2	.120	1.900	3/8	1.000	MED80 ★	50
2	—	.090	2.197	3/8	1.250	MED85 ★	50
—	2	.120	2.375	3/8	1.250	MED90 ★	50

★ Made in USA

Fits EMT	Fits Rigid & IMC	A	Nom. Pipe O.D. B	Bolt C	D	Part #	Std Pkg
Stainless Steel (Type 304)							
1/2	—	.080	0.706	1/4	.875	MED30SS ★	100
—	1/2	.080	0.840	1/4	.875	MED40SS ★	100
3/4	—	.080	0.922	1/4	.875	MED45SS ★	100
—	3/4	.080	1.050	1/4	.875	MED50SS ★	100
1	—	.080	1.163	1/4	.875	MED55SS ★	100
—	1	.080	1.315	1/4	.875	MED60SS ★	100
—	1 1/4	.090	1.660	5/16	1.000	MED70SS ★	100
—	1 1/2	.120	1.900	3/8	1.000	MED80SS ★	50
—	2	.120	2.375	3/8	1.250	MED90SS ★	50

★ Made in USA 🛡 Harsh Environment Product

ONE-HOLE STRAP • JIFFY CLIP®

HEAVY DUTY Series

- With the same original inverted rib and “Snap-On” features as the medium Jiffy Clip®, this is our strongest, heavy-duty one-hole strap series.
- Zinc plated steel.

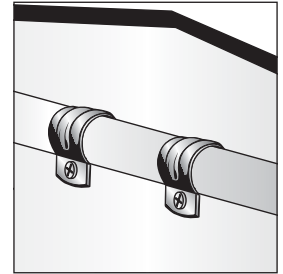
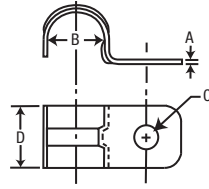

Fits Rigid & IMC	Fits EMT	A	Nom. Pipe O.D. B	Bolt C	D	Part #	Std Pkg
Zinc Plated							
—	½	.120	0.706	¼	.875	H30 ★	100
½	—	.120	0.840	¼	.875	H40 ★	100
—	¾	.120	0.922	¼	.875	H45 ★	100
¾	—	.120	1.050	¼	.875	H50 ★	100
—	1	.120	1.163	¼	.875	H55 ★	100
1	—	.120	1.315	¼	.875	H60 ★	100
—	1¼	.120	1.510	⅝	1.000	H65 ★	100
1¼	—	.120	1.660	⅝	1.000	H70 ★	100
—	1½	.120	1.740	⅝	1.000	H75 ★	50
1½	—	.120	1.900	¾	1.250	H80 ★	50
—	2	.120	2.197	¾	1.250	H85 ★	25
2	—	.187	2.375	¾	1.250	H90 ★	25
2½	2½	.187	2.875	⅞	1.250	H92 ★	25
3	3	.187	3.500	⅞	1.250	H94 ★	10
3½	3½	.250	4.000	⅞	1.250	H95 ★	10
4	4	.250	4.500	⅞	1.250	H96 ★	10
5	—	.250	5.563	⅞	1.500	H97 ★	10
6	—	.250	6.625	⅞	1.500	H98 ★	10

★ Made in USA

- Slotted Jiffy Clips® are a one-hole pipe strap with slotted mounting hole. This enables the installer to final position the clips after the run is completed.
- Copper plated steel. Parts provide compatibility with copper.
- Also available in brass. Call customer service for pricing and minimum order quantities.

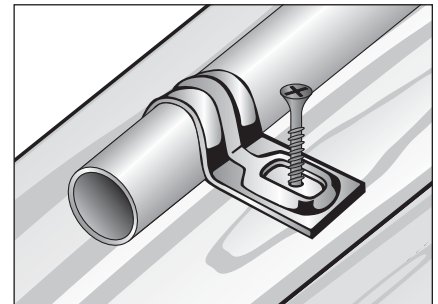

Copper Tubing O.D.	Part #	Std Pkg
Copper Plated		
¼	105SC ★	100
⅜	115SC ★	100



★ Made in USA

MINERALLAC TRADITIONAL

ONE-HOLE DUPLEX • JIFFY CLIP®

- For positioning double lines, these one-hole pipe clamps are ideal for cable, tube, BX or combinations thereof.
- Pre-galvanized steel.
- Also available in brass or copper plated steel. Call customer service for pricing and minimum order quantities.

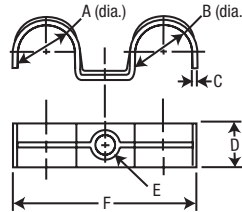
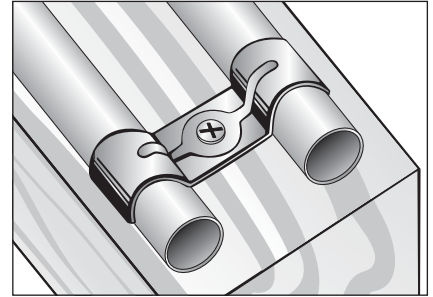

300A

Cable or Tubing		C	D	Bolt E	F	Part #	Std Pkg
A	B						
Pre-Galvanized							
.125	.125	.035	.500	3/16	.990	300A ★	100
.250	.250	.035	.500	3/16	1.260	300 ★	100
.375	.375	.035	.500	3/16	1.570	301 ★	100
.500	.500	.035	.500	3/16	1.800	305 ★	100

★ Made in USA

SLOTTED DUPLEX • JIFFY CLIP®

- For positioning double lines.
- These copper plated steel parts provide compatibility with copper.
- Other sizes are also available. Call customer service for pricing and minimum order quantities.

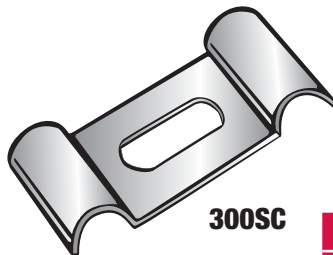
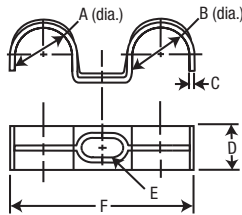
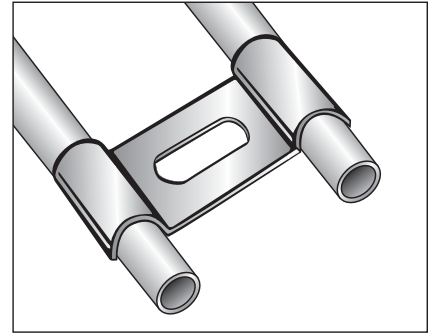

300SC

Cable or Tubing		C	D	E	F	Part #	Std Pkg
A	B						
Copper Plated							
.250	.250	.035	.500	.370	1.375	300SC ★	100
.375	.375	.035	.500	.380	1.510	301SC ★	100

★ Made in USA

CONDUIT STRAP • TWO-HOLE METAL

- Two-hole metal straps are designed for use on loads too heavy to be supported by one-hole Jiffy Clips.
- Pre-galvanized steel, except for 280, 290, 292 and 294 which are zinc plated.
- Available in zinc plated steel or made from stainless steel for corrosive environments.
- Also available in brass or hot-dipped galvanized steel. Call customer service for pricing and minimum order quantities.
- For information on Plastic Two-Hole Straps, available in nine sizes, turn to page 201.

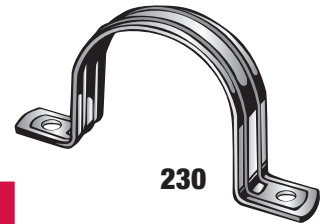
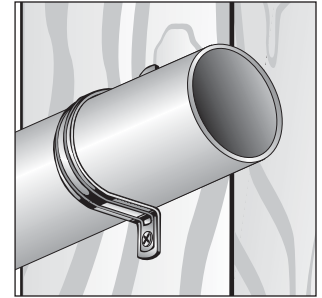
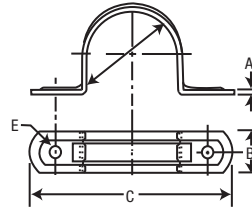

Fits EMT	Fits Rigid & IMC	A	B	C	Bolt E	Part #	Std Pkg
Pre-Galvanized							
—	¼	.035	.625	1.765	⅛	225 ★	100
—	⅜	.035	.750	2.515	⅜	228 ★	100
½	—	.035	.750	2.558	⅜	230 ★	100
—	½	.035	.750	2.565	⅜	240 ★	100
¾	—	.035	.750	2.765	⅜	245 ★	100
—	¾	.035	.750	2.795	⅜	250 ★	100
1	—	.035	.750	3.205	⅜	255 ★	100
—	1	.035	.750	3.140	⅜	260 ★	100
1¼	—	.050	.875	3.875	¼	265 ★	100
—	1¼	.050	.875	4.375	¼	270 ★	100
1½	—	.050	1.000	4.300	¼	275 ★	100
—	1½	.060	1.000	4.585	¼	280* ★	100
2	—	.050	1.000	5.000	¼	285 ★	100
—	2	.060	1.250	5.030	⅝	290* ★	50
2½	2½	.060	1.250	6.125	⅜	292* ★	50
3	3	.090	1.250	7.438	⅜	294* ★	25
Stainless Steel (Type 304)							
½	—	.035	.750	2.558	⅜	230SS ★ ♡	100
—	½	.035	.750	2.565	⅜	240SS ★ ♡	100
¾	—	.035	.750	2.765	⅜	245SS ★ ♡	100
—	¾	.035	.750	2.795	⅜	250SS ★ ♡	100

*Zinc plated

★ Made in USA

♡ Harsh Environment Product

MINERALLAC TRADITIONAL

CONDUIT STRAP • TWO-HOLE METAL



HD260

- Heavy-Duty Two-Hole Straps are designed for heavy loads.
- Zinc plated steel.
- Also available in hot-dipped galvanized steel. Call customer service for pricing and minimum order quantities.

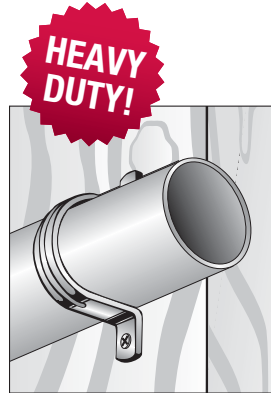
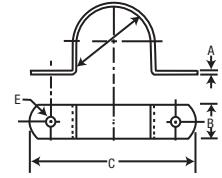

Fits Rigid & IMC	Fits EMT	A	B	C	Bolt E	Part #	Std Pkg
Zinc Plated							
1	—	.090	.750	3.092	3/16	HD260 ★	100
1¼	—	.080	.875	4.400	¼	HD270 ★	100
1½	—	.090	1.000	4.590	¼	HD280 ★	50
2	—	.090	1.250	5.100	5/16	HD290 ★	25
2½	2½	.090	1.250	6.188	3/8	HD292 ★	25
3	3	.120	1.250	7.125	3/8	HD294 ★	10
3½	3½	.187	1.250	8.750	5/8	HD295 ★	10
4	4	.187	1.250	9.063	5/8	HD296 ★	10
5	—	.250	1.250	10.680	5/8	HD297 ★	10
6	—	.250	1.250	12.140	5/8	HD298 ★	10

★ Made in USA

MULTI-USE TWO-HOLE PLASTIC STRAPS

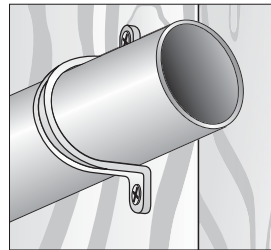

- Designed for strength.
- Easy to install. Plastic straps fit snugly over PVC or rigid conduit.
- Made from high quality UV stabilized and fire resistant material.

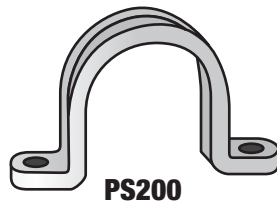

PS200

Trade Size	Color	Part #	Std Pkg
½	Gray	PS50 ★ ♡	50
¾	Gray	PS75 ★ ♡	50
1	Gray	PS100 ★ ♡	25
1¼	Gray	PS125 ★ ♡	25
1½	Gray	PS150 ★ ♡	25
2	Gray	PS200 ★ ♡	25
2½	Gray	PS250 ★ ♡	25
3	Gray	PS300 ★ ♡	10
4	Gray	PS400 ★ ♡	10

★ Made in USA

♡ Harsh Environment Product

MULTI-PURPOSE CLOSED CLIP

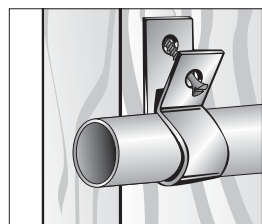

- Supports tubing pipe in sizes ¼" O.D.
- Pre-galvanized steel.

Tubing O.D.	Part #	Std Pkg
Pre-Galvanized		
¼	1105 ★	100

★ Made in USA



1105

SERVICE ENTRANCE STRAPS • ONE-HOLE

- Secures type SEU service entrance cables.
- Available in zinc plated steel or made from aluminum. MED2 and MED3 are made from pre-galvanized steel.

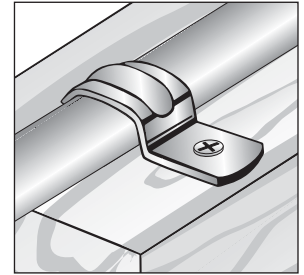
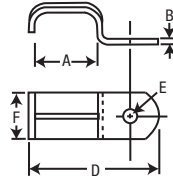

Cable Size	Inside Dia. A	B	D	Bolt E	F	Part #	Std Pkg
Zinc Plated							
NM (Romex)	.460	.045	1.080	3/16	.625	MED2* ★	100
UF	.550	.045	1.190	3/16	.625	MED3* ★	100
—	1.050	.074	2.056	1/4	.625	MED5 ★	100
6, 4	.835	.080	2.148	1/4	.875	MED7 ★	100
—	.970	.080	2.125	1/4	.875	MED9 ★	100
2	1.090	.080	2.275	1/4	.875	MED12 ★	100
1/0 & 2/0	1.275	.080	2.665	1/4	.875	MED13 ★	100
—	1.465	.120	2.880	1/4	.875	MED14 ★	100
—	1.675	.120	3.355	1/4	1.000	MED16 ★	100
—	1.209	.120	2.500	1/4	.875	H12 ★	100
4/0	1.570	.120	3.060	1/4	1.000	H16 ★	100
Aluminum							
2	1.090	.080	2.275	1/4	.875	MED12A ★ ♡	100
1/0 & 2/0	1.275	.080	2.665	1/4	.875	MED13A ★ ♡	100
4/0	1.570	.120	3.355	1/4	1.000	H16A ★ ♡	100



MED2

***Pre-galvanized**

★ Made in USA

♡ Harsh Environment Product

- Secures type SER service entrance cables.
- Pre-galvanized steel, except 160 which is zinc plated.

SER & BX Fits Rigid or BX	Part #	Std Pkg
Pre-Galvanized		
BX: 14-2, 14-3, 12-2	121 ★	100
BX: 12-3, 10-2, 10-3, SER 8	125 ★	100
6, 4	130 ★	100
2	140 ★	100
1, 1/0	145 ★	100
2/0	150 ★	100
3/0	155 ★	100
4/0	160* ★	100

***Zinc plated**

★ Made in USA

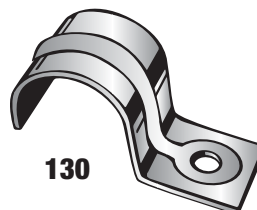
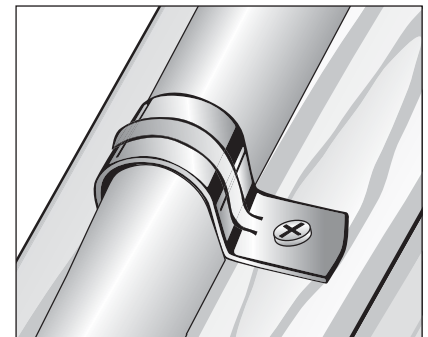

130

SERVICE ENTRANCE STRAPS • TWO-HOLE

- Secures type SEU service entrance cables.
- Pre-galvanized steel, except 212 which is zinc plated.

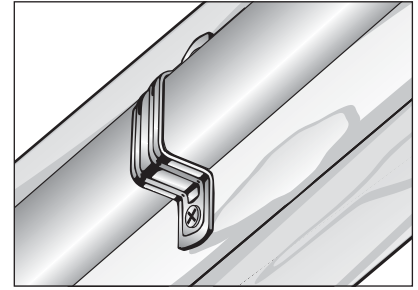
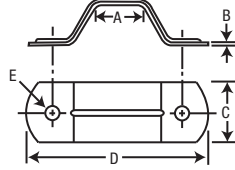
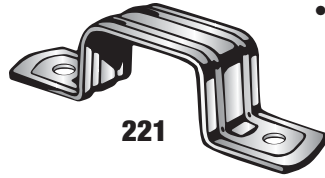

For SEU	A	B	C	D	Bolt E	Part #	Std Pkg
Pre-Galvanized							
Inside Width 0.425"	.425	.035	.750	2.070	1/8	221 ★	100
Inside Width 0.635"	.635	.050	.750	2.895	3/16	212* ★	100
2	.875	.035	.750	2.690	3/16	223 ★	100
1, 1/0, 2/0	1.100	.035	.750	3.018	3/16	2203 ★	100
3/0, 4/0	1.340	.035	.750	2.990	3/16	2403 ★	100

*Zinc plated ★ Made in USA

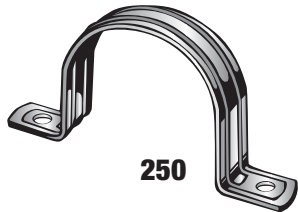

- Secures type SER and BX service entrance cables.
- Available made from pre-galvanized steel or stainless steel.

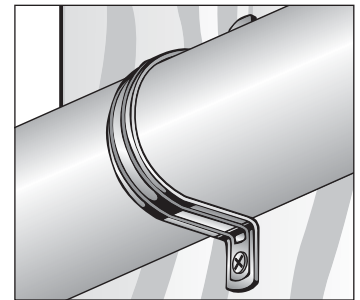
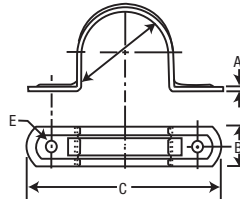

For SER & BX	A	B	C	Bolt E	Part #	Std Pkg
Pre-Galvanized						
BX, SER8	.035	.625	1.765	1/8	225 ★	100
6	.035	.750	2.515	3/16	228 ★	100
4	.035	.750	2.558	3/16	230 ★	100
2	.035	.750	2.565	3/16	240 ★	100
1, 1/0	.035	.750	2.765	3/16	245 ★	100
2/0	.035	.750	2.795	3/16	250 ★	100
3/0	.035	.750	3.205	3/16	255 ★	100
4/0	.035	.750	3.140	3/16	260 ★	100
Stainless Steel (Type 304)						
4	.035	.750	2.558	3/16	230SS ★ ♡	100
2	.035	.750	2.565	3/16	240SS ★ ♡	100
1, 1/0	.035	.750	2.765	3/16	245SS ★ ♡	100
2/0	.035	.750	2.795	3/16	250SS ★ ♡	100

★ Made in USA ♡ Harsh Environment Product

MINERALLAC TRADITIONAL

CONDUIT & BOX SUPPORT FASTENERS

- Secures conduit and electrical boxes to most structures.
- Provides conduit support on both sides of electrical box.
- With hole for screw or threaded rod mount or with ¼"-20 x ⅝" stud.
- Made from pre-galvanized steel with Black Claw™ spring steel fasteners riveted to part.
- This part with beam clamp attachment found on page 205.

Mount 4" Square Boxes For Use With	Part #	Std Pkg
⅜" Conduit	CBS18KC38 ★	25
½", ¾" Conduit	CBS18KC1234 ★	25
1" Conduit	CBS18KC1 ★	25

★ Made in USA

Stud Mount 4" Square Boxes For Use With	Part #	Std Pkg
⅜" Conduit	CBS18KC38ST	25
½", ¾" Conduit	CBS18KC1234ST	25
1" Conduit	CBS18KC1ST	25

- Secures conduit and electrical boxes to most structures.
- Provides conduit support on both sides of electrical box.
- With hole for screw or threaded rod mount or with ¼"-20 x ⅝" stud.
- Made from pre-galvanized steel with Black Claw™ spring steel fasteners riveted to part.
- This part with beam clamp attachment found on page 205.

Mount 4" Square Boxes For Use With	Part #	Std Pkg
½" EMT	CBS18HIC50 ★	25
¾" EMT or ½" Rigid	CBS18HIC75 ★	25
1" EMT or ¾" Rigid	CBS18HIC100 ★	25

★ Made in USA

Stud Mount 4" Square Boxes For Use With	Part #	Std Pkg
½" EMT	CBS18HIC50ST	25
¾" EMT or ½" Rigid	CBS18HIC75ST	25
1" EMT or ¾" Rigid	CBS18HIC100ST	25

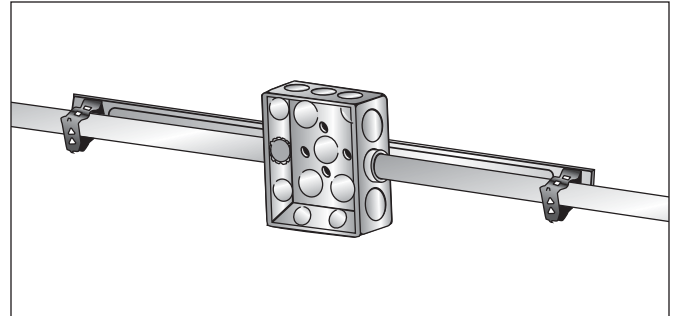

CBS18KC1234

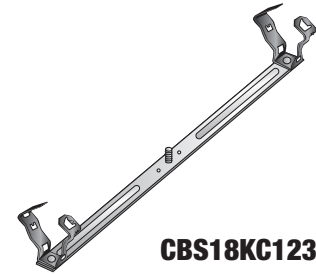
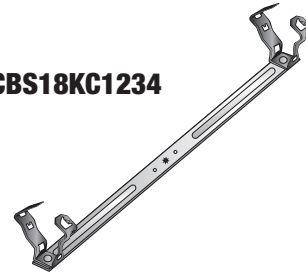

CBS18KC1234ST

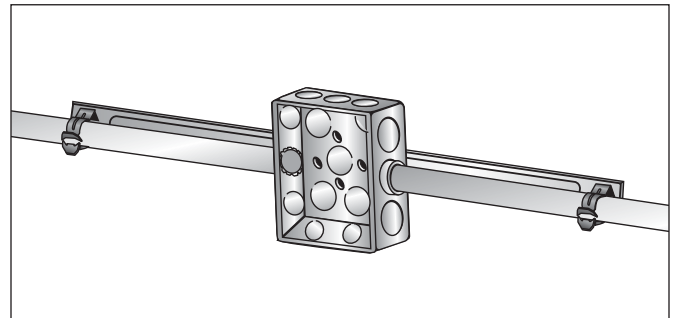

CBS18HIC100

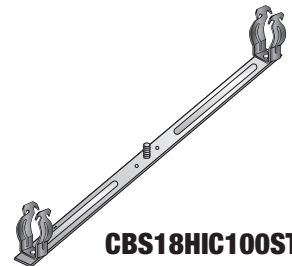
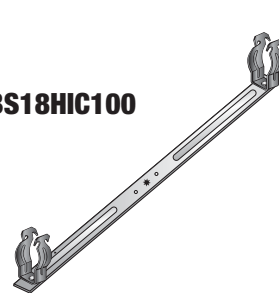

CBS18HIC100ST

CONDUIT & BOX SUPPORT ASSEMBLY

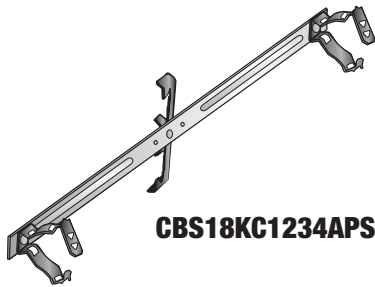
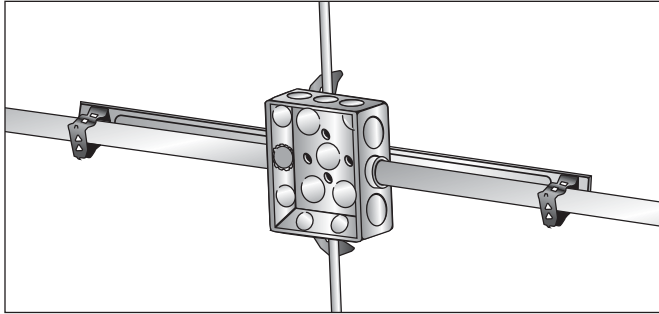

CBS18KC1234APS

- Provides conduit support on both sides of electrical box.
- Attaches to #12 wire thru 3/8" rod.
- Made from pre-galvanized steel with Black Claw™ spring steel fasteners riveted to part.
- This part with beam clamp attachment, instead of multi-function clip shown below, found on page 210.

Mount 4" Square Boxes For Use With	Part #	Std Pkg
3/8" Conduit	CBS18KC38APS ★	25
1/2", 3/4" Conduit	CBS18KC1234APS ★	25
1" Conduit	CBS18KC1APS ★	25

★ Made in USA

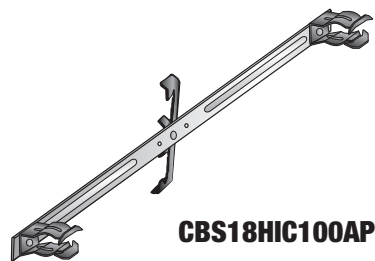
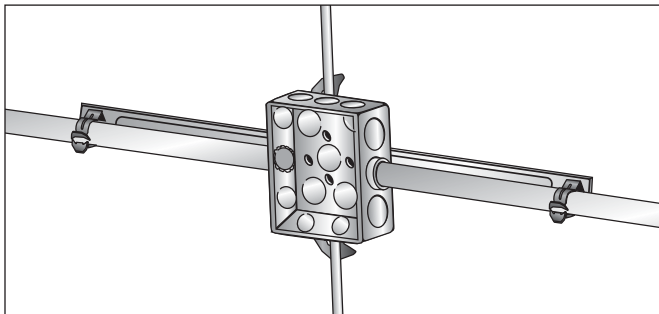

CBS18HIC100APS

- Provides conduit support on both sides of electrical box.
- Attaches to #12 wire thru 3/8" rod.
- Made from pre-galvanized steel with Black Claw™ spring steel fasteners riveted to part.
- This part with beam clamp attachment, instead of multi-function clip shown below, found on page 210.

Mount 4" Square Boxes For Use With	Part #	Std Pkg
1/2" EMT	CBS18HIC50APS ★	25
3/4" EMT or 1/2" Rigid	CBS18HIC75APS ★	25
1" EMT or 3/4" Rigid	CBS18HIC100APS ★	25

★ Made in USA

GROUND WIRE CLIP

- Easy to use. Simply place wire into elbow, hammer nail through hole, then bend extension over nail head.
- Made from pre-galvanized steel.
- Also available in copper. Call Customer service for pricing and minimum order quantities.

Description	Part #	Std Pkg
Ground Wire Clips	GWC1 ★	1000

★ Made in USA

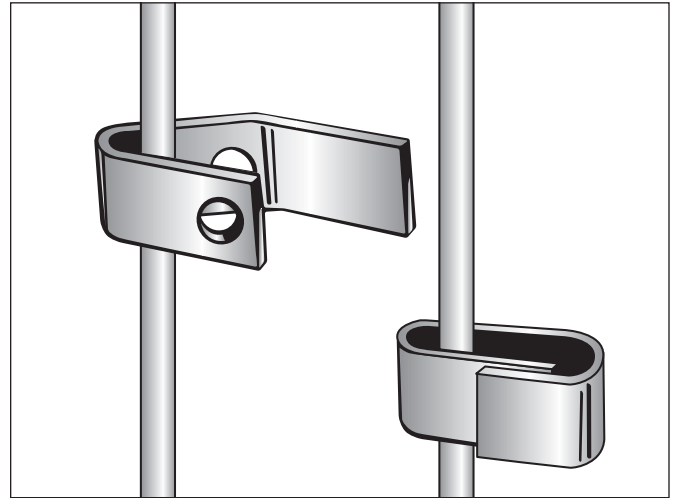

NAIL STRAPS • COMBO EMT/RIGID • STAMPED

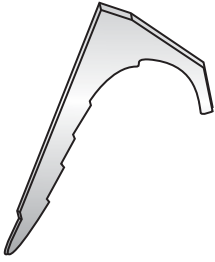

- For rigid, IMC or EMT conduit.
- Barbs on flat nail straps minimize back-out.
- Flat nail straps are made from pre-galvanized steel.

				Best Merchandising Option	
				Gravity Feed Jar	
Description	Gauge	Part #	Box Qty	Part #	Jar Qty
½ EMT or ¾ Rigid Pipe	12	90108 ★	100	90108J ★	100/600
¾ EMT or ½ Rigid Pipe	12	90112 ★	100	90112J ★	100/600
1 EMT or ¾ Rigid Pipe	12	90116 ★	100	90116J ★	100/600

★ Made in USA

ROUND NAIL STRAPS • COMBO EMT/RIGID • GALVANIZED

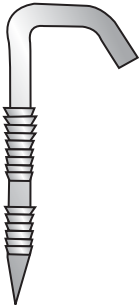

- Drives like a nail. Fast and easy to install.
- For rigid, IMC or EMT conduit.
- Knurling on shank of round nail straps minimize back out.
- Round nail straps are zinc plated after fabrication.

Description	Gauge	Part #	Box Qty
½ EMT or ¾ Rigid Pipe	12	90109 ★	100
¾ EMT or ½ Rigid Pipe	12	90113 ★	100
1 EMT or ¾ Rigid Pipe	12	90117 ★	100

★ Made in USA

BEAM CLAMPS • UNIVERSAL

- Used with Minerallac conduit hangers #0 to #5, bridle rings and threaded rod. Tapped for rods bottom and back except #602 (bottom only).
- Case hardened steel set screw tapped at an angle locks on beam.
- Available in zinc plated steel or made from stainless steel.

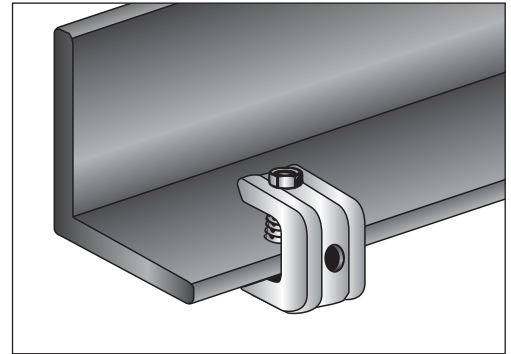
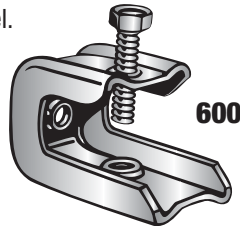
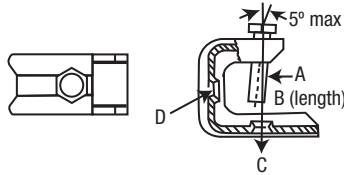

Fits Flange	Tapping	Drop Rod	Static Load Limit Bottom Hole Only	Screw Diameter A	Screw Length B	Bottom Thread C	Back Thread D	Part #	Std Pkg
Zinc-Plated Steel									
1/2	1/4"-20	1/4	75 lbs	1/4"-20	1	1/4"-20	1/4"-20	600 ★	50
1/2	#10-24	#10-24	75 lbs	1/4"-20	1	10-24	10-24	60010 ★	50
3/4	3/8" Bottom Only	3/8	200 lbs	5/16"-18	1 3/8	3/8"-16	None	602 ★	25
3/4	3/8"-16	3/8	200 lbs	5/16"-18	1 3/8	3/8"-16	3/8"-16	602B ★	25
Stainless Steel (Type 304)									
3/4	3/8"-16	3/8	200 lbs	5/16"-18	1 3/8	3/8"-16	3/8"-16	602BSS ★ ♡	25

★ Made in USA ♡ Harsh Environment Product

BEAM CLAMPS • MALLEABLE

- Used with Conduit Hangers, Bridle Rings and Drop Rods, 3/8" to 1/2". Tapped for rods bottom and back on all sizes.
- Malleable iron zinc plated.

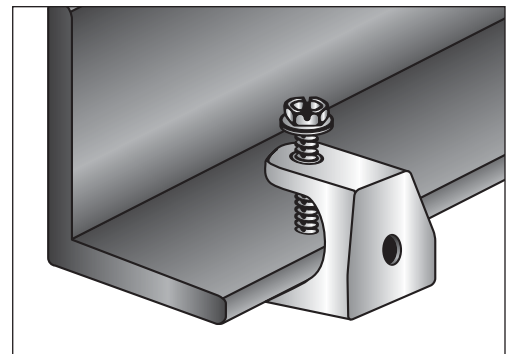
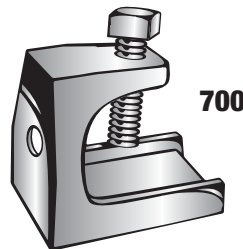
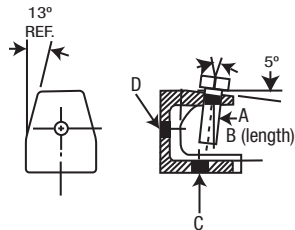

Fits Flange	Tapping	Drop Rod	Static Load Limit Bottom Hole Only	Screw Diameter A	Screw Length B	Bottom Thread C	Back Thread D	Part #	Std Pkg
Zinc Plated Malleable Iron									
5/8	1/4"-20	1/4	275 lbs	5/16"-18	1 1/4	1/4"-20	1/4"-20	700	50
3/4	#10-24	#10-24	275 lbs	1/4"-20	1 1/4	10-24	10-24	70010	50
3/4	5/16"-18	5/16	525 lbs	3/8"-16	1 1/4	5/16"-18	5/16"-18	701	25
3/4	3/8"-16	3/8	750 lbs	1/2"-13	1 1/2	3/8"-16	3/8"-16	702	25
7/8	1/2"-13	1/2	900 lbs	5/8"-11	1 1/2	1/2"-13	1/2"-13	703	25

MINERALLAC TRADITIONAL

BEAM CLAMP ASSEMBLIES

- Our #600 beam clamp with #0 through #5 Conduit Hangers attached.
- Offered with or without nut and bolt attached.
- Zinc plated steel.

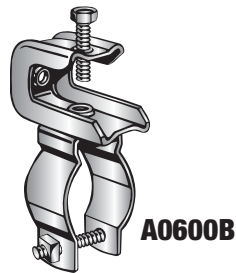
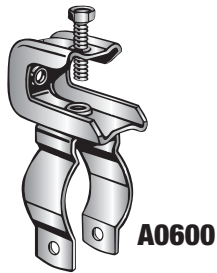
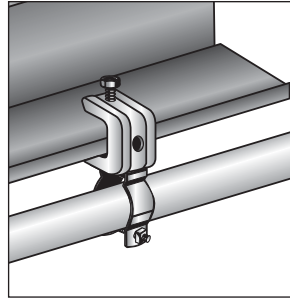

Fits EMT	Fits Rigid/MC	Part #	Std Pkg
Zinc Plated Without Bolt			
1/2	3/8-1/2	A0600 ★	100
3/4	3/4	A1600 ★	100
1	1	A2600 ★	100
1 1/4	—	A2-1/2 600 ★	100
1 1/2	1 1/4	A3600 ★	100
—	1 1/2	A4600 ★	50
2	2	A5600 ★	50
Zinc Plated With Bolt			
1/2	3/8-1/2	A0600B	100
3/4	3/4	A1600B	100
1	1	A2600B	100
1 1/4	—	A2-1/2 600B	100
1 1/2	1 1/4	A3600B	100
—	1 1/2	A4600B	50
2	2	A5600B	50

★ Made in USA

FLANGE/T-BAR CLIP • TWO-PIECE

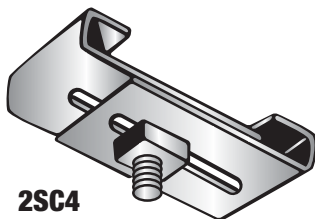

Static Load Limit: 100 lbs

- Fits flanges from 1 5/8" to 2 5/8" width and up to 1/4" thick.
- 1/4"-20 stud with nut.
- Zinc plated steel.

Fits Conduit	Part #	Std Pkg
Zinc Plated		
Fits 1 5/8" to 2 5/8" Wide Flanges; Up to 1/4" Thick	2SC4	100

BEAM MOUNT CONDUIT & BOX SUPPORT ASSEMBLY

- Provides conduit support on both sides of electrical box.
- Attaches to beam flanges from 1/8" to 1/2" thick.
- Made from pre-galvanized steel with Black Claw™ spring steel fasteners riveted to part.

Mount 4" Square Boxes		Part #	Std Pkg
Conduit Size	Flange Thickness		
3/8	1/8-1/4	CBS18KC3818 ★	25
3/8	5/16-1/2	CBS18KC38516 ★	25
1/2-3/4	1/8-1/4	CBS18KC123418 ★	25
1/2-3/4	5/16-1/2	CBS18KC1234516 ★	25
1	1/8-1/4	CBS18KC118 ★	25
1	5/16-1/2	CBS18KC1516 ★	25

★ Made in USA

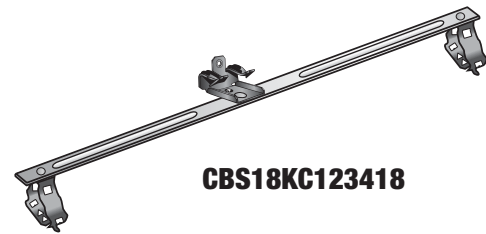
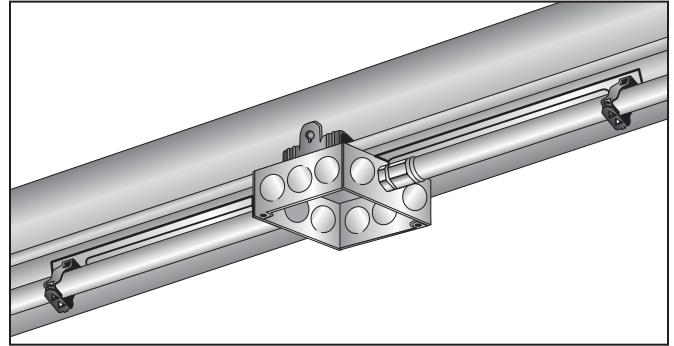

CBS18KC123418

- Provides conduit support on both sides of electrical box.
- Attaches to beam flanges from 1/8" to 1/2" thick.
- Made from pre-galvanized steel with Black Claw™ spring steel fasteners riveted to part.

Mount 4" Square Boxes		Part #	Std Pkg
Conduit Size	Flange Thickness		
1/2" EMT	1/8-1/4	CBS18HIC5018 ★	25
1/2" EMT	5/16-1/2	CBS18HIC50516 ★	25
3/4" EMT or 1/2" Rigid	1/8-1/4	CBS18HIC7518 ★	25
3/4" EMT or 1/2" Rigid	5/16-1/2	CBS18HIC75516 ★	25
1" EMT or 3/4" Rigid	1/8-1/4	CBS18HIC10018 ★	25
1" EMT or 3/4" Rigid	5/16-1/2	CBS18HIC100516 ★	25

★ Made in USA

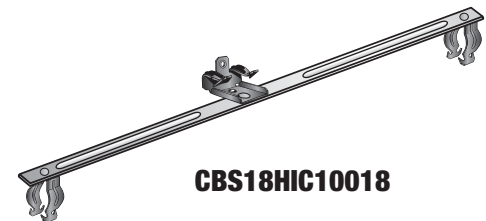
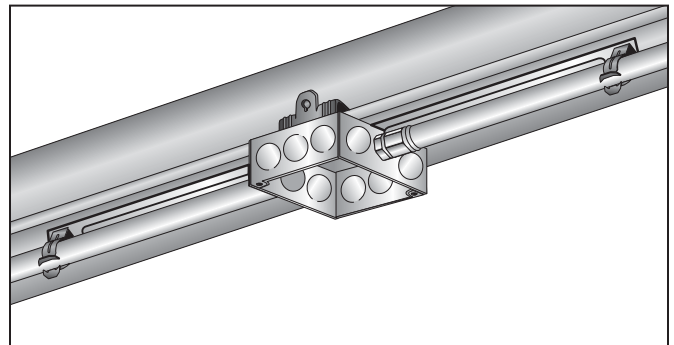

CBS18HIC10018

BOX MOUNTING BRACKET

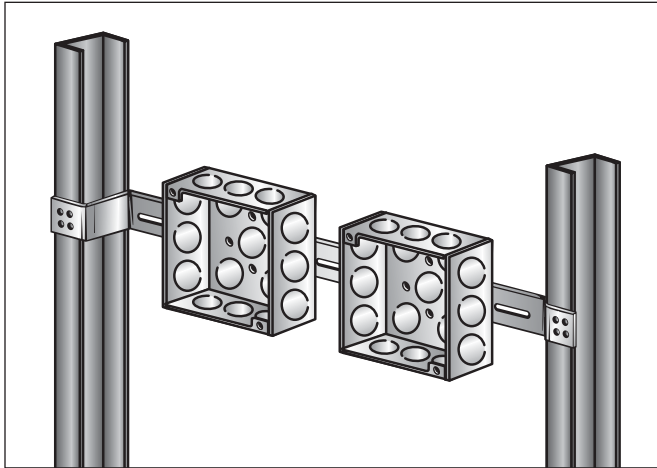

- Supports electrical boxes located between studs on 16" or 24" centers. Boxes attach using self-tapping screws.
- Made from pre-galvanized steel.

Description	Part #	Std Pkg
1½" Box to Studs on 16" Centers	BMB16 ★	50
2⅞" Box to Studs on 16" Centers	BMB16D ★	50
1½" Box to Studs on 24" Centers	BMB24 ★	50
2⅞" Box to Studs on 24" Centers	BMB24D ★	50

★ Made in USA

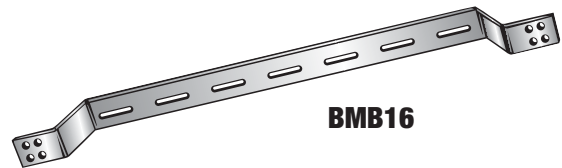

BOX TO BAR FASTENER

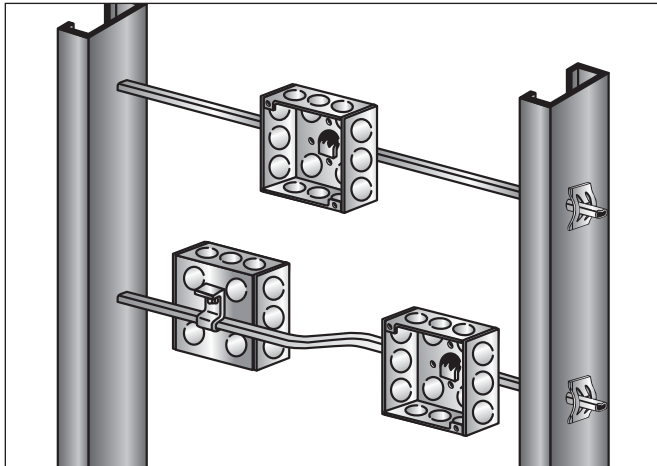

- Black Claw™ Spring Steel hardware is included.
- Bars made from pre-galvanized steel.

Description	Part #	Std Pkg
1 Straight 26"-Long Bar 1 BBC, 2 BSC	BAR ★	50
1 Offset 26"-Long Bar 2 BBC, 2 BSC	RBAR ★	50

★ Made in USA

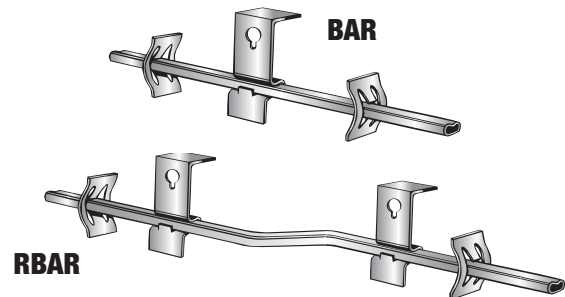

OUTLET RETAINER

- Mounts standard outlets and wall switches in oversize openings, lending stability and preventing broken cover plates.
- Made from pre-galvanized steel.

Description	Part #	Std Pkg
Mounts Standard Outlets In Oversize Openings	OR ★	100

★ Made in USA

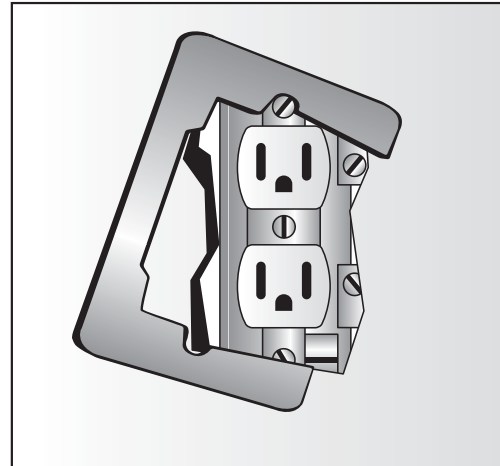
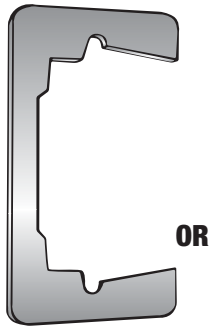

MINERALLAC TRADITIONAL

BOX MOUNTING BRACKET

- Bracket supports electrical boxes from floor or channels.
- Can be used at three heights.
- Made from pre-galvanized steel.

Description	Part #	Std Pkg
Break-A-Way Feature for 12", 16", 18" Lengths	BS18 ★	50

★ Made in USA

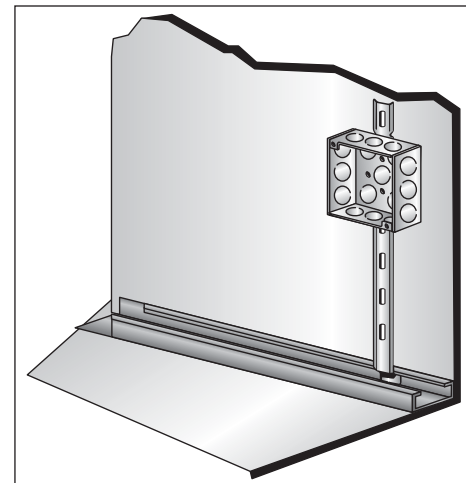

BOX STABILIZER SUPPORT

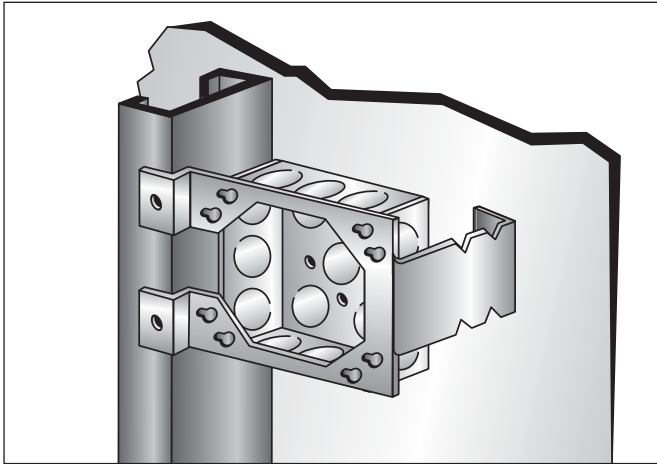

Description	Part #	Std Pkg
Box Support for 2½" and 3½" Wood or Metal Studs	FB023 ★	100
Box Support for 2½", 3½" and 4" Wood or Metal Studs	FB0234 ★	100
Box Support for 6" Wood or Metal Studs	FB06 ★	100

★ Made in USA

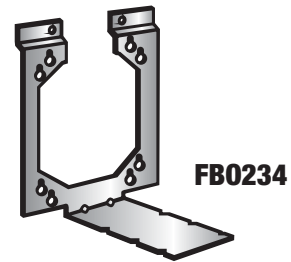

BOX SUPPORTS • SCREWLESS DESIGN • GALVANIZED STEEL

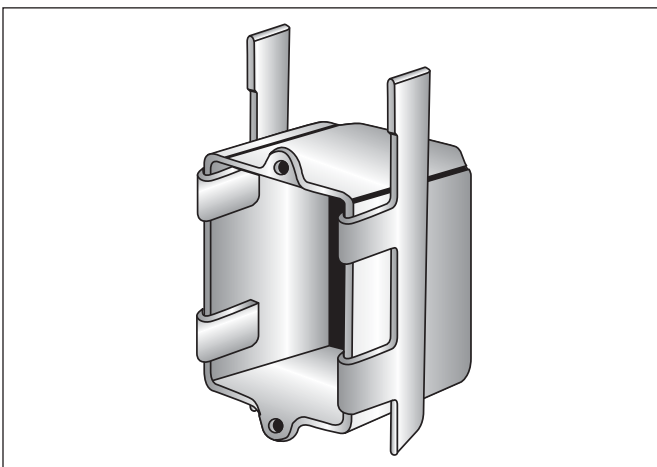

- Holds switch boxes and outlets firmly in place.
- Quick installation.
- One-piece break-away design.
- Box is supported by drywall. No stud is necessary.
- Prevents box from pulling out of drywall.
- Made from pre-galvanized steel.

Description	Part #	Std Pkg
Secures Electrical Box to Finished Drywall	BST ★	100 Sets

★ Made in USA



PLASTIC FAR SIDE BOX SUPPORT

- No tools required. Mounts quickly in the back of the box. Just push in and snap tight.
- Designed for 3 5/8" steel studs.
- May be used on standard 1 1/2" or 2 1/8" deep boxes.

Description	Part #	Std Pkg
Designed for use with 3 5/8" steel studs. May be used on standard 1 1/2" boxes or 2 1/8" deep boxes.	DLS1	100

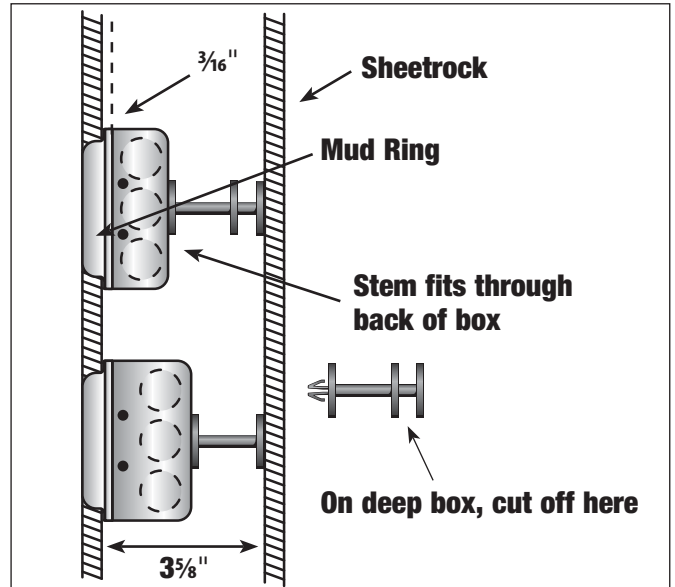
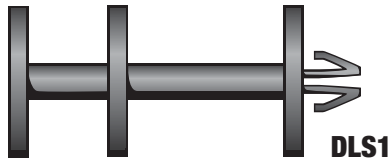

BOX TO T-BAR FASTENER

- Snap-on 24" span box hanger with dual height adjustment allows flush or 3/4" offset mount.
- Pre-galvanized steel with Black Claw™ spring steel hardware included.

Description	Part #	Std Pkg
24"-Long Box Hanger, 1 BBC Mounting Clip with Screw	TBAR	50

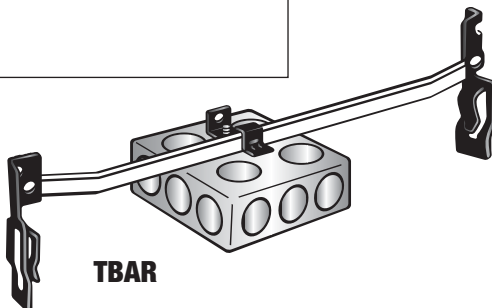
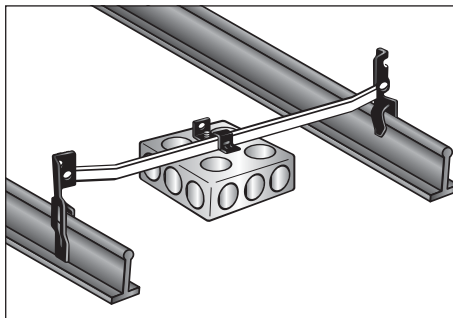

LIGHTING SUPPORT ASSEMBLY

- Snap-on 24" fixed span with adjustable fixture position.
- Installed with screwdriver.
- Pre-galvanized steel with Black Claw™ spring steel hardware.

Description	Part #	Std Pkg
Fits LIGHTOILER 5 and CALCULITE® Series Fixtures	LSBAR ★	25 Sets

★ Made in USA

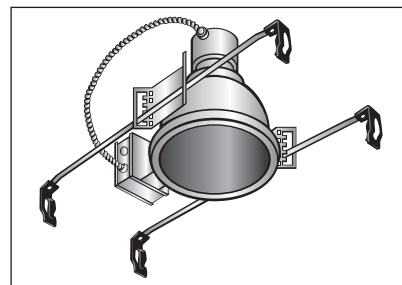

T-BAR HANGER • TWO PIECE

- Mounts fixtures or boxes to 1" T-bar with Ultimate Static Load Limit of 75 lbs.
- Stud is flat head, square shoulder carriage bolt which will not turn when positioned in slot. Assembled with 1" OD wing nut washer.

Description	Part #	Std Pkg
Has 1/4"-20 x 5/8" Stud with Wing Nut and Washer	SCT2	100

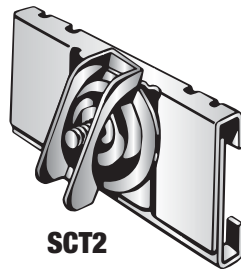
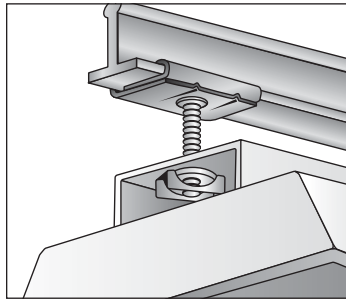

T-BAR SCISSOR CLIPS

- Two-piece zinc plated clip used for mounting fixtures or boxes to 1" T-bar with Ultimate Static Load Limit of 100 lbs.
- Includes wing nut washer.

For Use With		Part #	Std Pkg
Stud Length	T-Bar		
5/8"	19	SCX1W ★	50
2"	19	SCX1XL ★	50

★ Made in USA

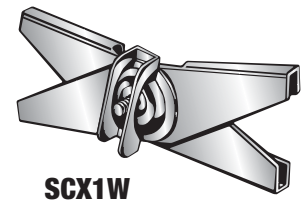
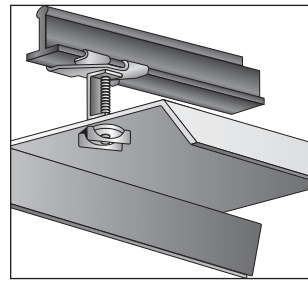

T-BAR DROP WIRE CLIP

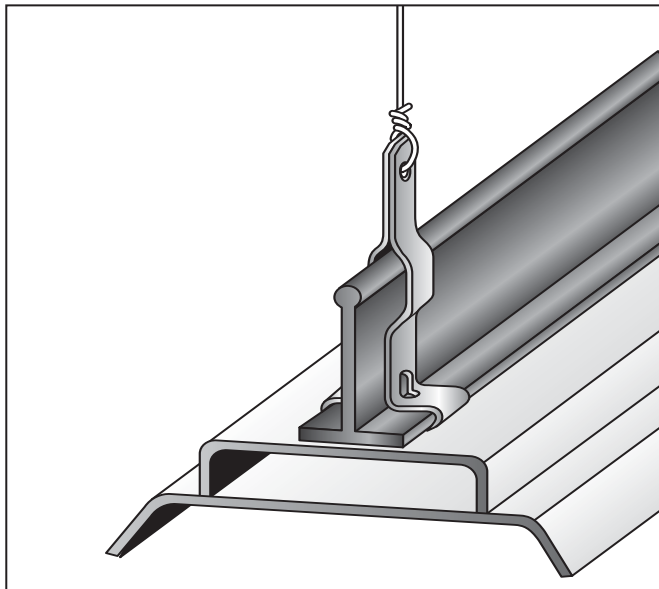

- These pre-galvanized clips support fixtures transmitting the weight of the fixture directly to the building structure, thus relieving the tee grid from any load stress. Also adds rigidity and support for truer alignment of the tee grid. Made from one-piece construction to accommodate various styles of tee grid.
- Includes wing nut washer.

For Use With		Part #	Std Pkg
Stud Length	T-Bar		
5/8"	1"	DWC1	50

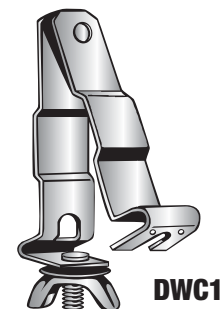

CABLE SUPPORT • J-HOOKS

Another Solution for Today's Challenging Installations!

The new 2" J-Hook cable support system, designed to be versatile, can be attached to a wide variety of structures using beam clamps, clips, and many other support components available from Minerallac. The wide-base support eliminates the undesirable impact of point-loads that can cause band-width deterioration and damage to Category 5 and 6, fiber-optic, and other sensitive cables. This unique system saves both time and labor - another efficient method of cable installation!

J-Hook Cable System

- Cost effective alternative to expensive cable tray.
- Accommodates Category 5 and 6, fiber-optic, and interduct.
- Provides support without stress to sensitive voice/data cables.
- Continuous wide-base radius supports natural curve of cable, eliminating kinking, bending, and crimping.
- Cable wire retainer is supplied with every part.

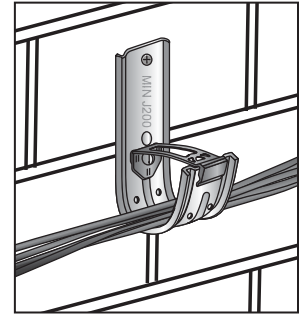

Fig 1



Fig 2



Fig 3



Fig 4



Fig 5



Fig 6



Fig 7



Fig 8



Fig 9



Fig 10



Fig 11

Description	Fig	Part #	Std Pkg
2" J-Hook	1	J200 ★	50
2" J-Hook with Bracket	2	J200B ★	50
Hammer On – 1/6"–1/4" Angled Z Purlin	3	J200ABC25 ★	50
Fits #12 Wire Thru 3/8" Rod and 1/8"–3/8" Flange	4	J200APS ★	50
Hammer On – 1/8"–1/4" Flange	5	J200SFC18 ★	50
Hammer On – 5/16"–1/2" Flange	5	J200SFC516 ★	50
Hammer On – 9/16"–3/4" Flange	5	J200SFC916 ★	50
Hammer On – 1/6"–1/4" Vertical Flange	6	J200VBC25 ★	50
Screw On – Up To 1/2" Flange	7	J200600 ★	50
Screw On – Up To 1/2" Flange	8	J200500	50
Hammer On – 1/8"–1/4" Flange	9	J200BBC18 ★	50
Hammer On – 5/16"–1/2" Flange	9	J200BBC516 ★	50
Hammer On – 9/16"–3/4" Flange	9	J200BBC916 ★	50
Screw On – Up To 1/2" Flange	10	J200B600 ★	50
Screw On – Up To 1/2" Flange	11	J200B500	50

★ Made in USA

MINERALLAC TRADITIONAL

CABLE SUPPORT • BRIDLE RINGS

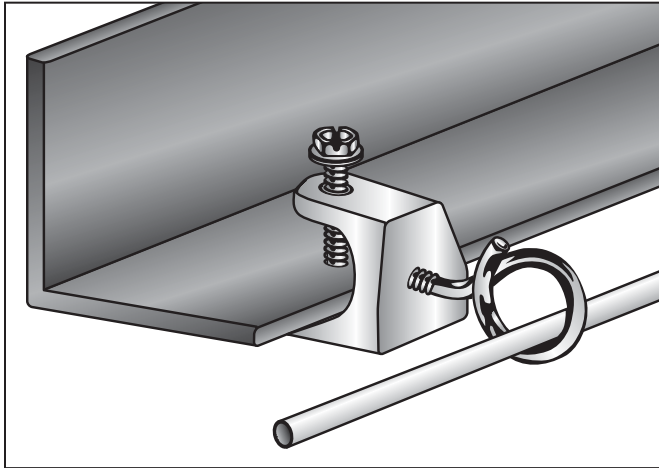

- Supports communications cable and other low voltage uses. Can be used with Minerallac Beam Clamps.
- Zinc plated steel.
- Also available in stainless steel. Call Customer service for pricing and minimum order quantities.

Ring Size	Thread	Part #	Std Pkg
1" Diameter	10-24	634R ★	100
1½" Diameter	¼"-20	646R ★	100
2" Diameter	¼"-20	648R ★	100
4" Diameter	¼"-20	654R ★	50

★ Made in USA



648R

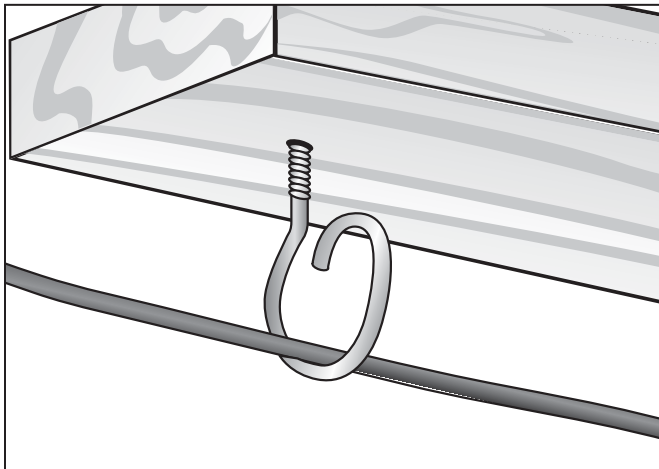

- Supports communications cable and other low voltage uses from wood beams.
- Zinc plated steel.
- Also available in stainless steel. Call Customer service for pricing and minimum order quantities.

Ring Size	Thread	Part #	Std Pkg
1" Diameter	⅜	634RW ★	100
1½" Diameter	¼	646RW ★	100
2" Diameter	¼	648RW ★	100

★ Made in USA



648RW

CABLE SUPPORT • BRIDLE RINGS

- Cost effective alternative to cable tray.
- Wide surface saddle provides support without stress for Category 5 and 6, fiber-optic and other sensitive voice/datacom cables.
- Available as assembled units or saddle only for retrofit.
- Saddle molded onto 4" bridle ring.

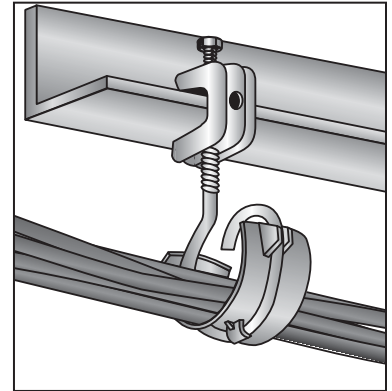

Saddle Assembly Description	Part #	Std Pkg
Mechanical Thread		
1½" Bridle Ring with Saddle	646RS ★	50
2" Bridle Ring with Saddle	648RS ★	50
4" Bridle Ring with Saddle	654RS ★	50
Lag Thread		
1½" Bridle Ring with Saddle	646RWS ★	50
2" Bridle Ring with Saddle	648RWS ★	50

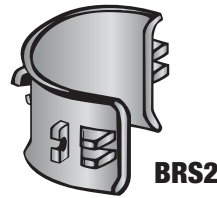

BRS2

US Patent No. 6,325,338



648RS

Saddle Only Description	Part #	Std Pkg
Snaps into 1½" Bridle Ring	BRS15 ★	100
Snaps into 2" Bridle Ring	BRS2 ★	100

★ Made in USA

UNIVERSAL PLASTIC METAL STUD GROMMET

- Protects wires from damage by metal studs.
- Easy to install—no tools required.
- Complies with 2011 NEC Article 300.4B/(1).

Description	Part #	Std Pkg
Grommets for Metal Studs	G100 ★	100

★ Made in USA



G100

CABLE PROTECTION • NAIL PLATES

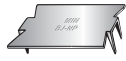

BJNP



NP6



BJNPH



NP6M



NP3



NP12



NP18

- Protects data/com, PVC plumbing and electrical from punctures by nails or screws.
- Styles with teeth attach to wood studs with hammer.
- Styles with holes attach to wood or metal studs using nails or screws and a hammer or screwdriver.
- Required for compliance with 2011 NEC Article 300.4(A) or Plumbing Code 305.8.
- Constructed from pre-galvanized steel for corrosion resistance.

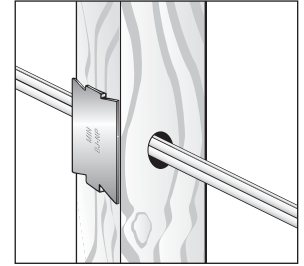

Size (L x W)	Part #	Std Pkg
2½ x 1½	BJNP ★	100
2½ x 1½	BJNPH ★	100
3 x 1½	NP3 ★	100
6 x 1½	NP6 ★	50
6 x 1½	NP6M ★	100
12 x 1½	NP12 ★	50
18 x 1½	NP18 ★	50

★ Made in USA

NAIL PLATES (SAFETY PLATES) • 16 GAUGE

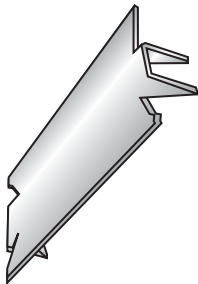

- Prevents drills and fasteners from penetrating framed-in cables and plastic pipes.
- Required for 2011 NEC Article 300.4(A) or Plumbing Code 305.8.

Length (L x W)	Gauge	Part #	Box Qty	Bucket Qty
3 x 1½	16	90100 ★	100	—
3 x 1½	16	90500 ★	500	—
3 x 1½	16	90505 ★	—	500
5 x 2	16	90600 ★	100	—
5 x 3	16	90605 ★	100	—

★ Made in USA

CABLE SUPPORT • D-RINGS

- Used to support multiple cable runs.
- Smooth non-conductive surface won't damage cable.
- Lower cost than steel distribution rings (D-rings).
- Parts made from high-strength, UV stabilized non-metallic composite.

Ring Size (H x W) Inside Opening	Part #	Std Pkg
2 ¼ x 2	DR20 ★ ⚡	50
3 ¼ x 3	DR30 ★ ⚡	25
3 ¼ x 5	DR40 ★ ⚡	10

★ Made in USA ⚡ Harsh Environment Product

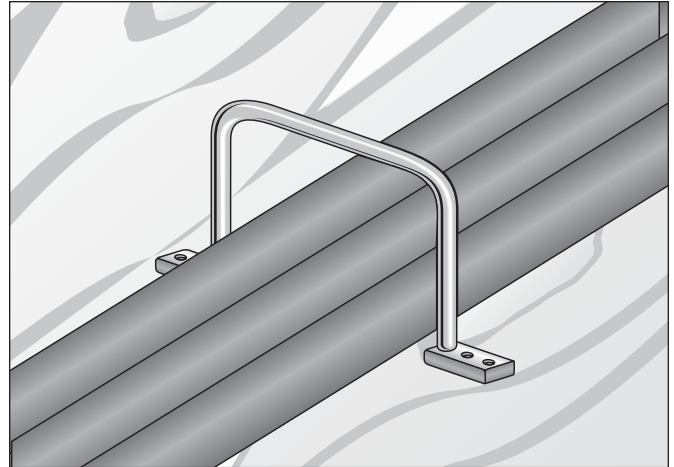

DR40

LOW VOLTAGE MOUNTING BRACKET

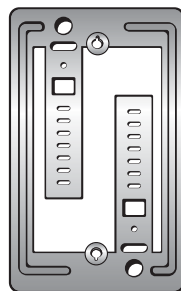
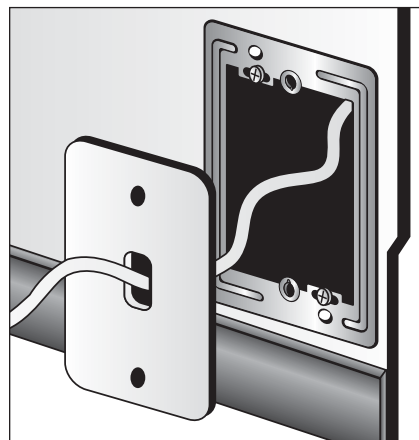

WBF1

- Provides base for securing communications lines without use of electrical box. Mounts standard plate.
- Hardware included.
- Made from pre-galvanized steel.

Description	Part #	Std Pkg
Mounts Standard Low Voltage Plates	WBF1	100

STOVE BOLT WITH NUT

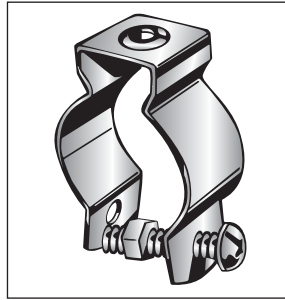
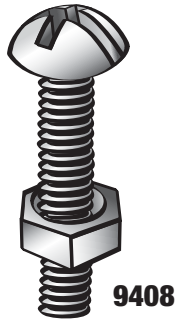

- Available in zinc plated steel, aluminum or stainless steel.

Thread	Length	Part #	Std Pkg
Zinc Plated			
¼"-20	1	25516	100
¼"-20	1¼	25520	100
¼"-20	1½	25524	100
Aluminum			
¼"-20	1¼	9410A ♠	100
Stainless Steel (18-8)			
¼"-20	1	25516SSJ ♠	100
¼"-20	1¼	25520SSJ ♠	100
¼"-20	1½	25524SSJ ♠	100

♠ Harsh Environment Product

WING NUT WASHER

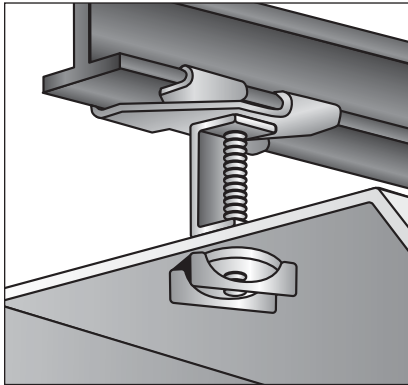

14WNW

- Made from zinc plated steel.

Wing Nut Washer Combo	Part #	Std Pkg
Fits ¼"-20 Bolt	14WNW ★	100

★ Made in USA

PERFORATED STRAPPING

- Used for hanging large size pipe or duct.
- Pre-galvanized steel.
- Other lengths of 0.035" x 3/4" and 0.050" x 7/8" perforated strapping available. Call Customer service for pricing and minimum order quantities.

Perforated Strap	Part #	Std Pkg
Pre-Galvanized 0.035" x 3/4"		
10' Coils	410C ★	100'
100' Coils	410C100 ★	100'
Pre-Galvanized 0.050" x 7/8"		
10' Coils	478C ★	100'

★ Made in USA



410C

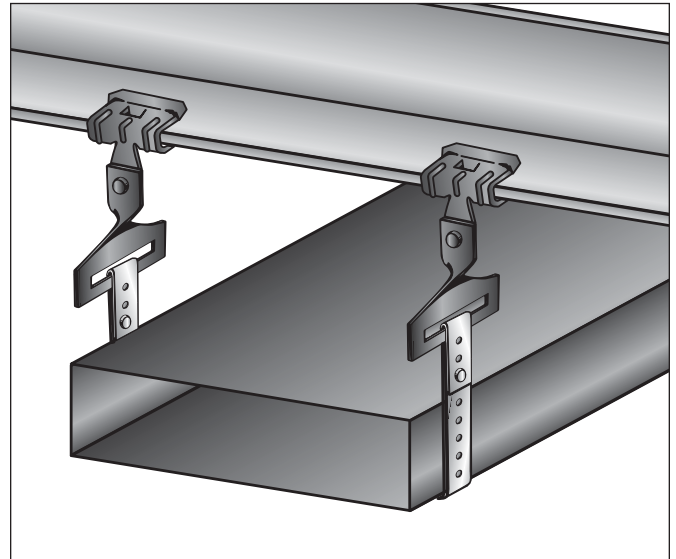

STUD CLIP ADAPTER

- Right angle fixture for attaching "S" hooks, or Jack Chain to drop rods, scissor clips or stud clips.
- Used with SCX1X, 2SC4, SCT3 and SCT2.
- Zinc plated steel.

Description	Part #	Std Pkg
For "S" Hooks or Fixture Chain	SCH48 ★	100

★ Made in USA



SCH48

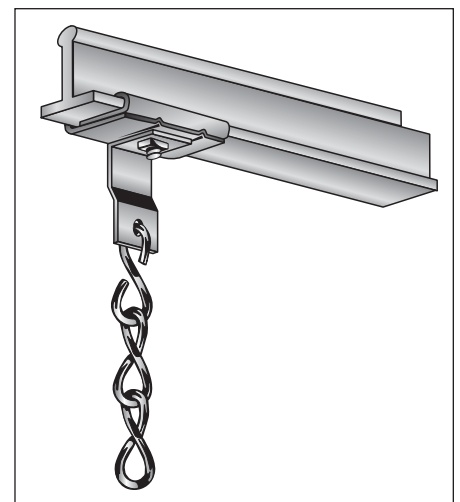

BRACKETS

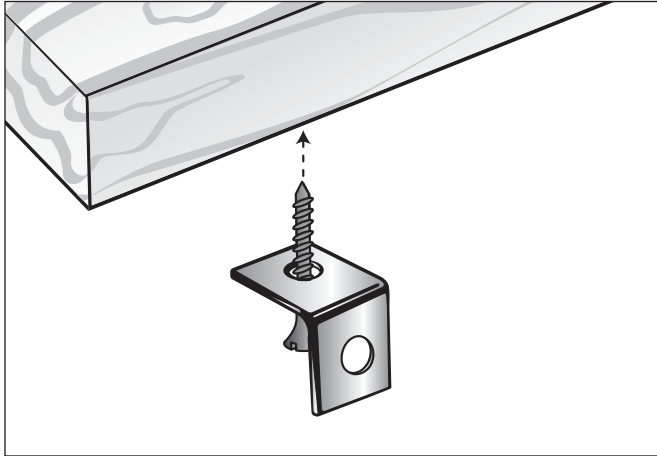

- These components, used riveted to other Minerallac products, are available separately for a variety of applications.
- Pre-galvanized steel.

Bolt Size	Part #	Std Pkg
Angle Bracket		
1/4" Mounting Hole	BA ★	100
Offset Bracket		
1/4" Mounting Hole	BO ★	100

★ Made in USA

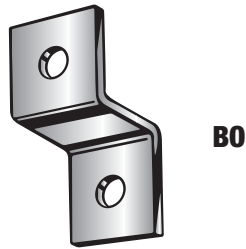
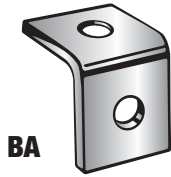

BAR JOIST WASHERS

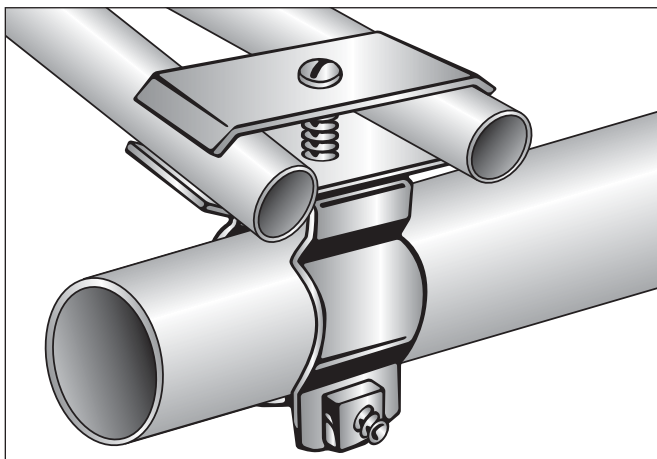

- Durable, rugged washers simplify and speed up the job of hanging conduit from bar joists.
- Zinc plated steel.

Bolt Size	Part #	Std Pkg
1/4	BJW4 ★	50 Pr
3/8	BJW6 ★	50 Pr

★ Made in USA

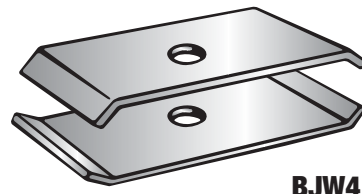

Black Claw™

By **Minerallac** Company

Strong, Swift and Efficient

Our Black Claw™ line of premium fasteners is constructed from high-carbon steel that has been engineered and manufactured to ensure a tight, secure “claw grip” on flanges, conduit, cable, studs and T-bars. Winning rave reviews by contractors, these products are hailed for their strength and efficient installation.

225-231 Conduit Cable

232-235 Hangers

236-240 Beam/Purlin

241-244 Metal Stud

245-247 Acoustical

248 Voice/Data & Low Voltage

249 Hardware/Accessories

**250-251 Compatability & Size
Reference Charts**



CONDUIT CLIP

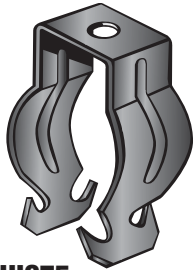

HIC75

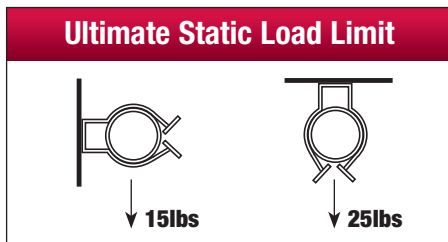
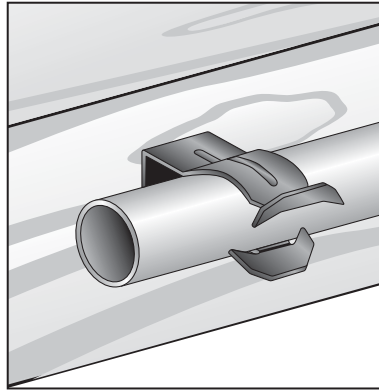

Ultimate Static Load Limit:
25lbs Vertical Position
15lbs Horizontal Position

- No fastener required.

Fits EMT	Fits Rigid/IMC	Part #	Std Pkg
1/2	—	HIC50 ★	100
3/4	1/2	HIC75 ★	100
1	3/4	HIC100 ★	100

★ Made in USA



KC1234

KC1234T

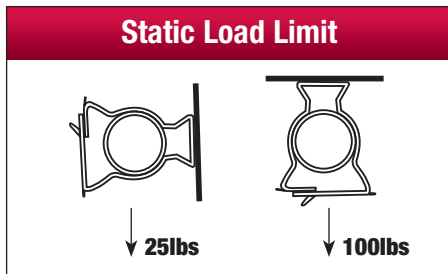
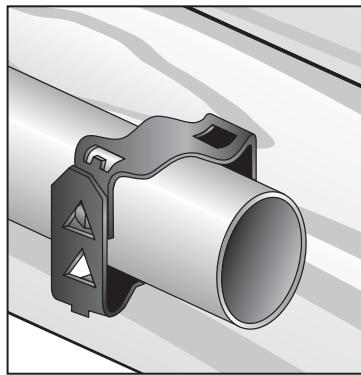

Static Load Limit:
100lbs Vertical Position
25lbs Horizontal Position

- No fastener required.
- 3/8", 1/2" and 3/4" available both non-keyholed and keyholed for 1/4"-20 screw.

Fits Conduit	Part #	Std Pkg
3/8	KC38 ★	100
1/2, 3/4	KC1234 ★	100
1	KC1 ★	100
1 1/4	KC114 ★	100
1 1/2	KC112 ★	100
2	KC2 ★	100

With Thread Impression for 1/4"-20	Part #	Std Pkg
3/8	KC38T ★	100
1/2, 3/4	KC1234T ★	100

★ Made in USA

BLACK CLAW

CONDUIT TO CONDUIT TRAPEZE ASSEMBLY

- No fastener required.
- Designed to quickly secure one conduit run to another.

NOTE: Top conduit to be used for support only, not a raceway.

Connects Conduit		Part #	Std Pkg
EMT	Rigid/IMC		
1/2 to 1/2	—	HIC5050 ★	100
1/2 to 3/4	—	HIC5075 ★	100
3/4 to 3/4	1/2 to 1/2	HIC7575 ★	100

★ Made in USA

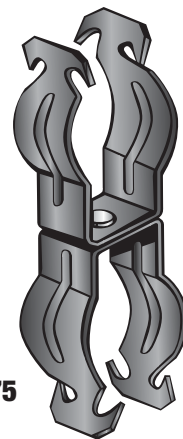
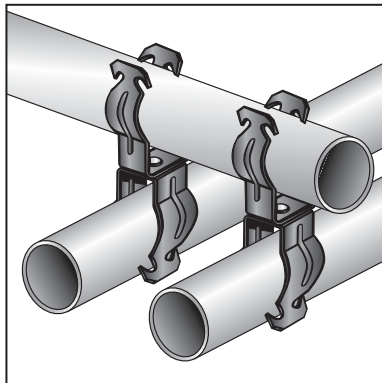

HIC7575

- Total load of trapeze must not exceed 100lbs.
- No fastener required.
- Designed to quickly secure one conduit run to another.

Connects Conduit	Part #	Std Pkg
3/8 to 1	KC38KC1 ★	100
3/8 to 1/2 or 3/4	KC38KC1234 ★	100
1/2 or 3/4 to 1/2 or 3/4	KC1234KC1234 ★	100

★ Made in USA

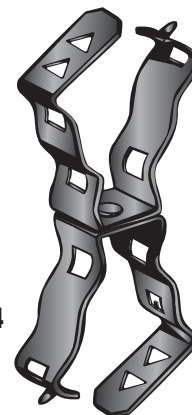
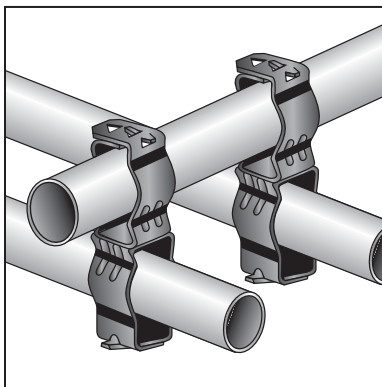

KC1234KC1234

CABLE CLIP

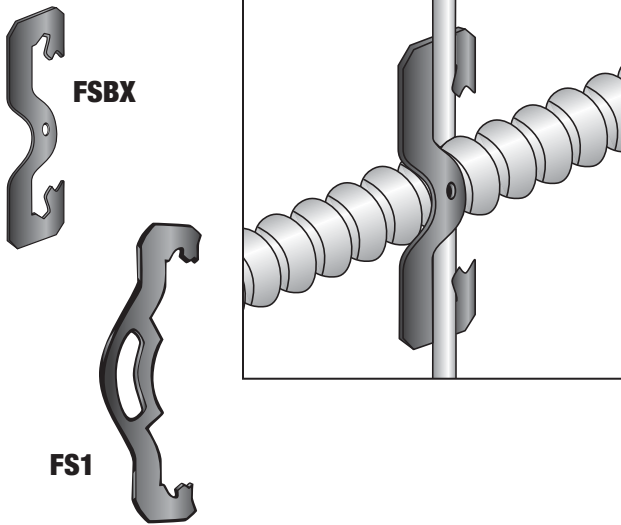

- Clip for MC, AC, or BX. Supports cable from #12 to #8 wire in horizontal or vertical position. O.D.'s from .433 to .535.

NOTE: These products are designed for positioning only. No load rating.

Cable Size	#12 Wire	#10 Wire	#8 & #9 Wire	Std Pkg
14-2 Cable	FSBX ★	FSBX ★	FSBX ★	100
14-3 Cable	FSBX ★	FSBX ★	FSBX ★	100
12-2 Cable	FSBX ★	FSBX ★	FSBX ★	100
12-3 Cable	FSBX ★	FS1 ★	FS1 ★	100

★ Made in USA

CONDUIT CLIP

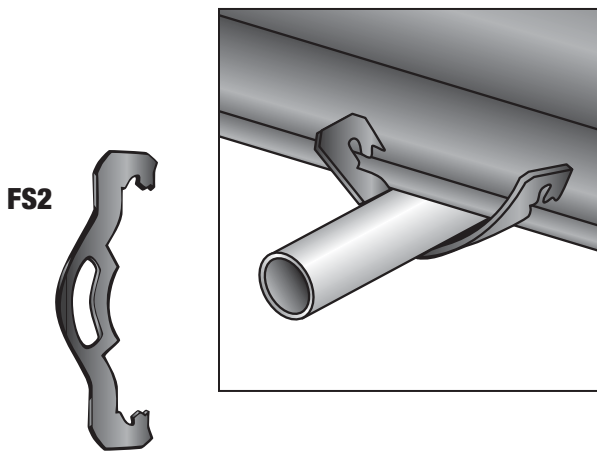

- Supports conduit and all types of cable from rods or flanges.

Conduit Size	#10 & #12 Wire	#8 & #9 Wire	3/16" to 1/4" Rod	Std Pkg
1/2" EMT	FS1 ★	FS1 ★	FS1 ★	100
1/2" RIGID	FS1 ★	FS2 ★	FS2 ★	100
3/4" EMT	FS2 ★	FS2 ★	FS2 ★	100
3/4" RIGID	FS2 ★	FS2 ★	FS3 ★	100
1" EMT	—	FS3 ★	FS3 ★	100
1" RIGID	—	—	—	100
1 1/4" EMT	—	FS4 ★	FS4 ★	100

Static Load Limit

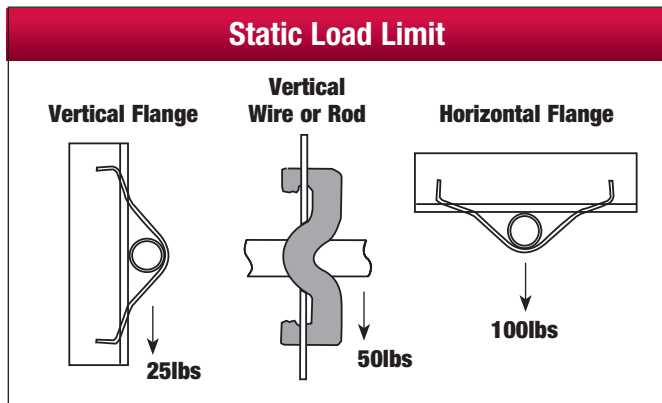

Conduit Size	1/89 to 1/49 Flange	5/169 to 3/89 Flange	7/169 to 1/29 Flange	Std Pkg
1/2" EMT	FS1 ★	FS2 ★	FS2 ★	100
1/2" RIGID	FS2 ★	FS2 ★	FS3 ★	100
3/4" EMT	FS2 ★	FS3 ★	FS3 ★	100
3/4" RIGID	FS3 ★	FS4* ★	FS4* ★	100
1" EMT	FS3 ★	FS4* ★	FS4* ★	100
1" RIGID	FS4* ★	FS4* ★	FS4* ★	100
1 1/4" EMT	FS4 ★	—	—	100

*For horizontal applications only.

★ Made in USA

MULTI-FUNCTION CLIP

- Attaches conduit or boxes to flanges, wire or rod.
- Attaches to #12 wire through 3/8" rod.
- Attaches #10-24 or 1/4"-20 threaded bridle rings (position only).

Description	Part #	Std Pkg
Fits 1/8" to 3/8" Flanges; #12 Wire through 3/8" Rod; #10-24 or 1/4"-20 Threaded Impressions	APS ★	100

★ Made in USA

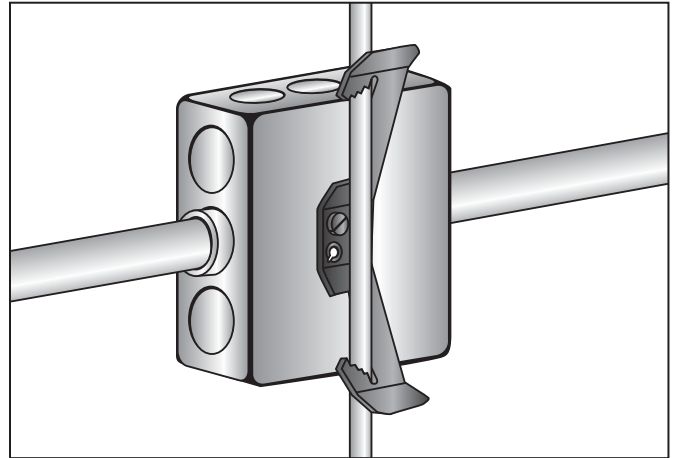

Static Load Limit (Flange)

50lbs 20lbs



MULTI-FUNCTION CLIP ASSEMBLIES

- Attaches conduit or boxes to flanges, wire or rod.

Fits		Part #	Std Pkg
EMT	Rigid/IMC		
1/2	—	APS50 ★	100
3/4	1/2	APS75 ★	100
1	3/4	APS100 ★	100

Fits Conduit	Part #	Std Pkg
1/2 & 3/4	APSKC1234 ★	100
1	APSKC1 ★	100

★ Made in USA

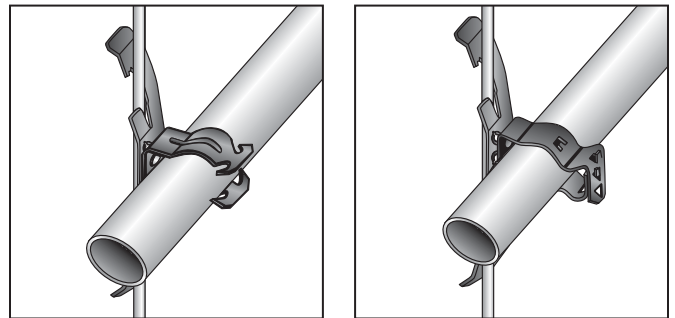

Ultimate Static Load Limit (Flange)

25lbs 15lbs

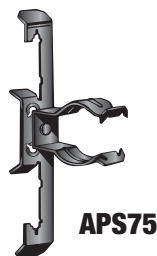

Static Load Limit (Flange)

50lbs 20lbs

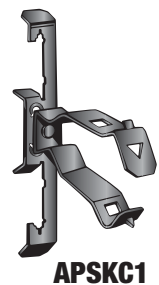

FLEXIBLE CONDUIT/CABLE CLIP

- Supports flexible conduit and all types of cable from flanges.
- Made from high-carbon steel and zinc plated.
- Some clips may require minimum order quantities. Please contact customer service.

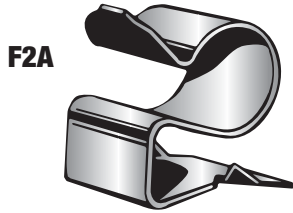
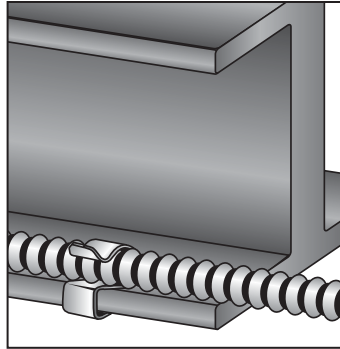

Description		Part #	Std Pkg
AC/MC Cable O.D.	Flange Size		
.218-.281	1/16-3/16	F2A ★	100
.312-.375	1/16-3/16	F2B ★	100
.375-.437	1/16-3/16	F2C ★	100
.468-.562	1/16-3/16	F2D ★	100
0.500-0.718	1/16-3/16	F2E ★	100
.750-.937	1/16-3/16	F2F ★	100
.968-1.250	1/16-3/16	F2G ★	100
.218-.281	3/16-9/32	F4A ★	100
.312-.375	3/16-9/32	F4B ★	100
.375-.437	3/16-9/32	F4C ★	100
.468-.562	3/16-9/32	F4D ★	100
0.500-0.718	3/16-9/32	F4E ★	100
.750-.937	3/16-9/32	F4F ★	100
.968-1.250	3/16-9/32	F4G ★	100
.218-.281	5/16-1/2	F8A ★	100
.312-.375	5/16-1/2	F8B ★	100
.375-.437	5/16-1/2	F8C ★	100
.468-.562	5/16-1/2	F8D ★	100
0.500-0.718	5/16-1/2	F8E ★	100
.750-.937	5/16-1/2	F8F ★	100
.968-1.250	5/16-1/2	F8G ★	100

★ Made in USA

FLANGE MOUNT CONDUIT CLIP ASSEMBLY

Ultimate Static Load Limit: 25lbs

- Suspends conduit from bottom of beam.
- Will pivot 360 degrees.
- Installs with hammer only.

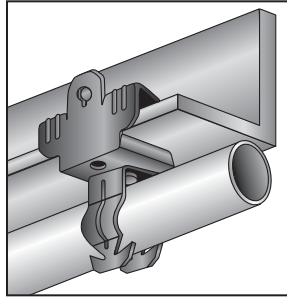

Static Load Limit: 75lbs

- Suspends conduit from bottom of beam.
- Will pivot 360 degrees.
- Installs with hammer only.

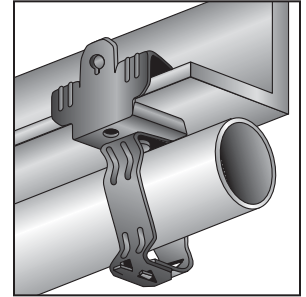

Ultimate Static Load Limit

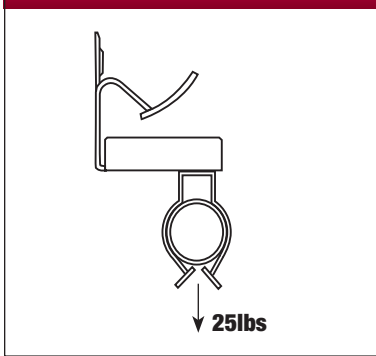

Bottom Mount



BC1875

Static Load Limit

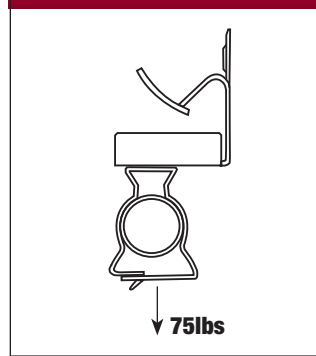

Bottom Mount

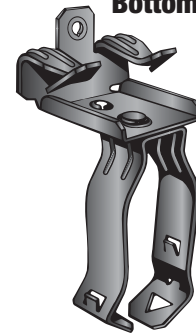

BC516KC1

Fits Flange	Fits EMT	Fits Rigid/IMC	Part #	Std Pkg
1/8-1/4	1/2	—	BC1850 ★	100
1/8-1/4	3/4	1/2	BC1875 ★	100
1/8-1/4	1	3/4	BC18100 ★	100
5/16-1/2	1/2	—	BC51650 ★	100
5/16-1/2	3/4	1/2	BC51675 ★	100
5/16-1/2	1	3/4	BC516100 ★	100

★ Made in USA

Fits Flange	Fits Conduit	Part #	Std Pkg
1/8-1/4	3/8	BC18KC38 ★	100
1/8-1/4	1/2 & 3/4	BC18KC1234 ★	100
1/8-1/4	1	BC18KC1 ★	100
1/8-1/4	1 1/4	BC18KC114 ★	100
1/8-1/4	1 1/2	BC18KC112 ★	100
1/8-1/4	2	BC18KC2 ★	100
5/16-1/2	3/8	BC516KC38 ★	100
5/16-1/2	1/2 & 3/4	BC516KC1234 ★	100
5/16-1/2	1	BC516KC1 ★	100
5/16-1/2	1 1/4	BC516KC114 ★	100
5/16-1/2	1 1/2	BC516KC112 ★	100
5/16-1/2	2	BC516KC2 ★	100
9/16-3/4	3/8	BC916KC38 ★	100
9/16-3/4	1/2 & 3/4	BC916KC1234 ★	100
9/16-3/4	1	BC916KC1 ★	100
9/16-3/4	1 1/4	BC916KC114 ★	100
9/16-3/4	1 1/2	BC916KC112 ★	100
9/16-3/4	2	BC916KC2 ★	100

★ Made in USA

FLANGE MOUNT CONDUIT CLIP ASSEMBLY

Ultimate Static Load Limit: 15lbs

- Suspends conduit from side of beam.
- Will pivot 360 degrees.
- Installs with hammer only.

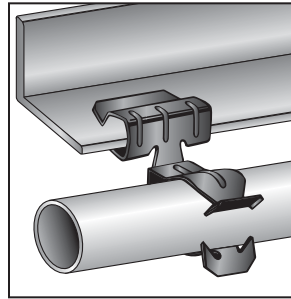

Static Load Limit: 25lbs

- Suspends conduit from side of beam.
- Will pivot 360 degrees.
- Installs with hammer only.

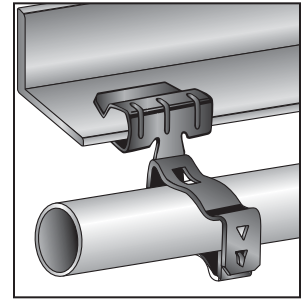

Ultimate Static Load Limit

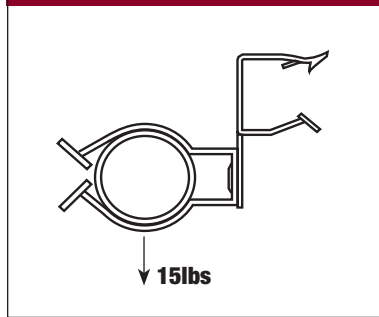

Side Mount

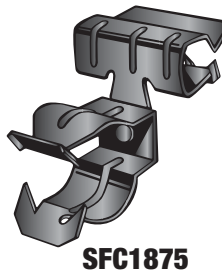

Static Load Limit

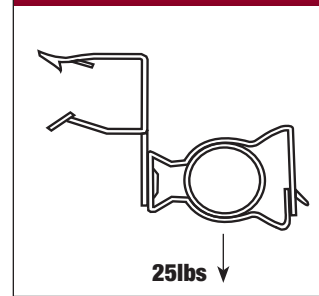

Side Mount

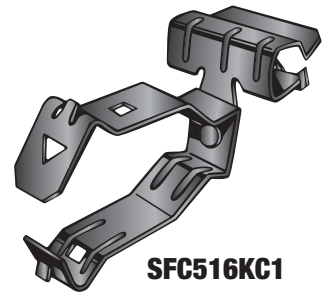

Fits Flange	Fits EMT	Fits Rigid/IMC	Part #	Std Pkg
1/8-1/4	1/2	—	SFC1850 ★	100
1/8-1/4	3/4	1/2	SFC1875 ★	100
1/8-1/4	1	3/4	SFC18100 ★	100

★ Made in USA

Fits Flange	Fits Conduit	Part #	Std Pkg
1/8-1/4	3/8	SFC18KC38 ★	100
1/8-1/4	1/2 & 3/4	SFC18KC1234 ★	100
1/8-1/4	1	SFC18KC1 ★	100
1/8-1/4	1 1/4	SFC18KC114 ★	100
1/8-1/4	1 1/2	SFC18KC112 ★	100
1/8-1/4	2	SFC18KC2 ★	100
5/16-1/2	3/8	SFC516KC38 ★	100
5/16-1/2	1/2 & 3/4	SFC516KC1234 ★	100
5/16-1/2	1	SFC516KC1 ★	100
5/16-1/2	1 1/4	SFC516KC114 ★	100
5/16-1/2	1 1/2	SFC516KC112 ★	100
5/16-1/2	2	SFC516KC2 ★	100
9/16-3/4	3/8	SFC916KC38 ★	100
9/16-3/4	1/2 & 3/4	SFC916KC1234 ★	100
9/16-3/4	1	SFC916KC1 ★	100

★ Made in USA

ROD/WIRE • BRACKET SUPPORT

Angle Brackets

Static Load Limit: 160lbs

- Suspends #8 wire, 1/4" and 3/8" plain or threaded rod from overhead mountings with a clearance hole for 1/4" bolt.
- Hangers made from high-carbon steel, zinc phosphate and oil finish. Angle bracket made from pre-galvanized steel.

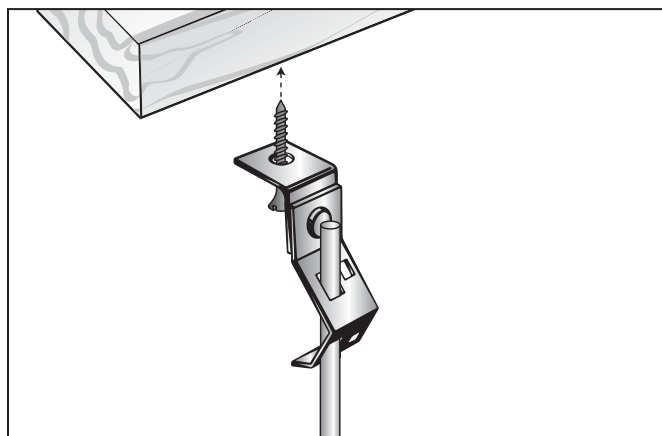

Offset Brackets

Static Load Limit: 160lbs

- Suspends #8 wire, 1/4" and 3/8" plain or threaded rod from overhead mountings with a clearance hole for 1/4" bolt.
- Hangers made from high-carbon steel, zinc phosphate and oil finish. Offset bracket made from pre-galvanized steel.

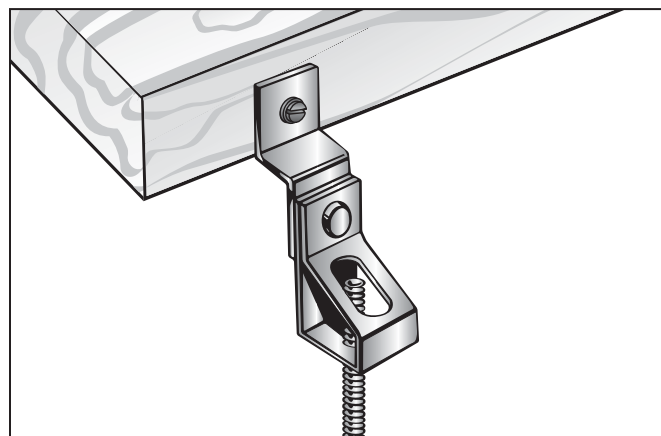

BLACK CLAW



RA14

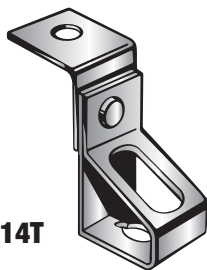

RA14T

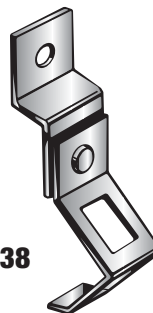

R038

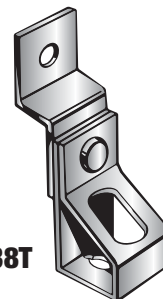

R038T

Angle Bracket Supports For Use With	Part #	Std Pkg
#8 Wire or 1/4" Plain Rod	RA14 ★	100
3/8" Plain Rod	RA38 ★	100
1/4" Threaded Rod with Thread Impression	RA14T ★	100
3/8" Threaded Rod with Thread Impression	RA38T ★	100
1/4" to 3/8" Threaded Rod*	RA1438N ★	100

*Nut required

★ Made in USA

Angle Bracket Supports For Use With	Part #	Std Pkg
#8 Wire or 1/4" Plain Rod	R014 ★	100
3/8" Plain Rod	R038 ★	100
1/4" Threaded Rod with Thread Impression	R014T ★	100
3/8" Threaded Rod with Thread Impression	R038T ★	100
1/4" to 3/8" Threaded Rod*	R01438N ★	100

*Nut required

★ Made in USA

ROD/WIRE BEAM ASSEMBLIES

Static Load Limit: 160lbs

- Suspends #8 wire, 1/4" and 3/8" plain rod from overhead mountings.

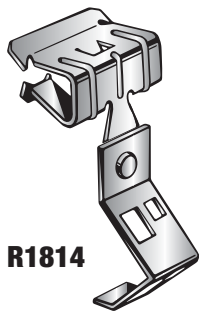
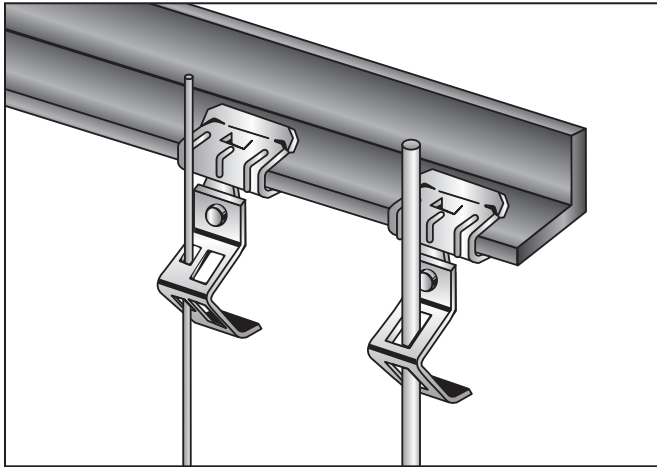

R1814

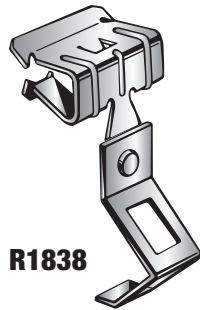

R1838

Flange Thickness	For Use With	Part #	Std Pkg
1/8-1/4	#8 Wire or 1/4" Plain Rod	R1814 ★	100
5/16-1/2	#8 Wire or 1/4" Plain Rod	R51614 ★	100
9/16-3/4	#8 Wire or 1/4" Plain Rod	R91614 ★	100
1/8-1/4	3/8" Plain Rod	R1838 ★	100
5/16-1/2	3/8" Plain Rod	R51638 ★	100
9/16-3/4	3/8" Plain Rod	R91638 ★	100

★ Made in USA

THREADED ROD TO BEAM ASSEMBLIES

Static Load Limit: 160lbs

- Suspends 1/4" and 3/8" threaded rod from overhead mountings.

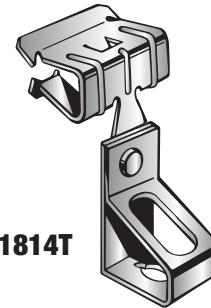
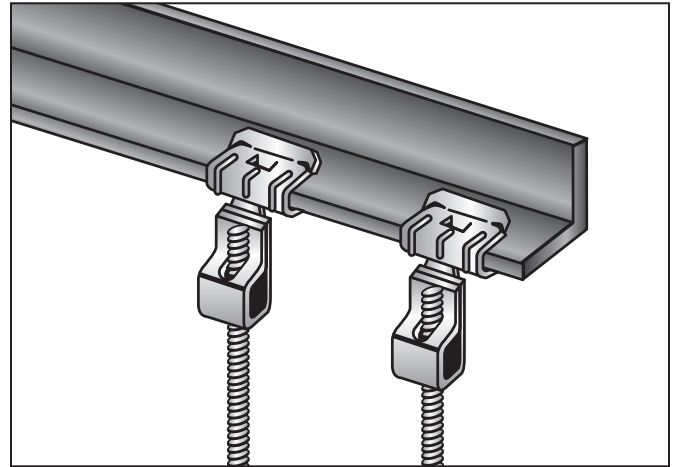

R1814T

Flange Thickness	For Use With (Thread Impression)	Part #	Std Pkg
1/8-1/4	1/4" Threaded Rod	R1814T ★	100
5/16-1/2	1/4" Threaded Rod	R51614T ★	100
9/16-3/4	1/4" Threaded Rod	R91614T ★	100
1/8-1/4	3/8" Threaded Rod	R1838T ★	100
5/16-1/2	3/8" Threaded Rod	R51638T ★	100
9/16-3/4	3/8" Threaded Rod	R91638T ★	100

★ Made in USA

STRAP HANGERS

Static Load Limit: 200lbs

- Suspends strapping thru 1" wide from beam flanges $\frac{1}{8}$ " to $\frac{3}{4}$ " thick, parallel or at right angles to beam.

Flange Thickness	Part #	Std Pkg
$\frac{1}{8}$ – $\frac{1}{4}$	PSF18 ★	100
$\frac{5}{16}$ – $\frac{1}{2}$	PSF516 ★	100
$\frac{9}{16}$ – $\frac{3}{4}$	PSF916 ★	100

Right Angle Strap Fits Flange Thickness	Part #	Std Pkg
$\frac{1}{8}$ – $\frac{1}{4}$	PSF18R ★	100
$\frac{5}{16}$ – $\frac{1}{2}$	PSF516R ★	100
$\frac{9}{16}$ – $\frac{3}{4}$	PSF916R ★	100

★ Made in USA

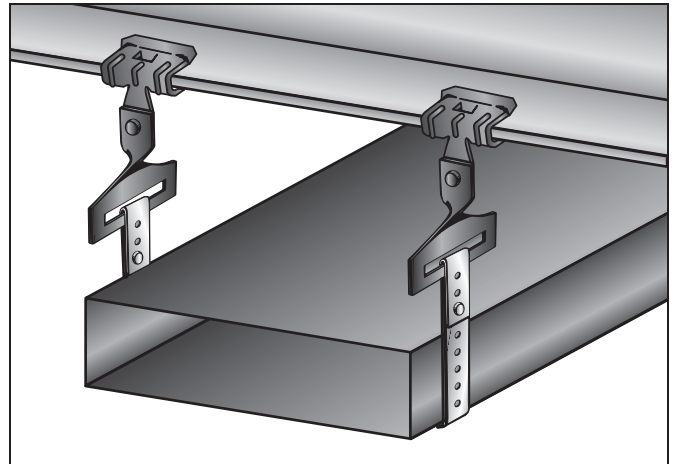

PSF18

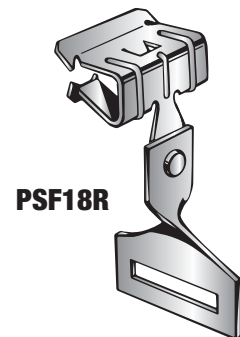

PSF18R

BLACK CLAW

BEAM CLAMPS

Static Load Limit: 75lbs or 100lbs

- Can be used to suspend boxes, fixtures and bridle rings to beam flanges 1/8" to 3/4" thick.
- Beam Clamp with 1/4"-20 x 3/8" staked stud used to suspend box from bottom of beam.

NOTE: Static load limits cannot be combined.

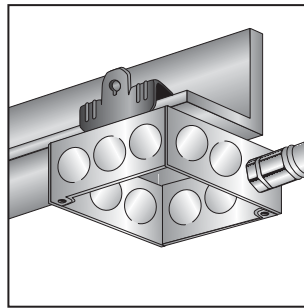
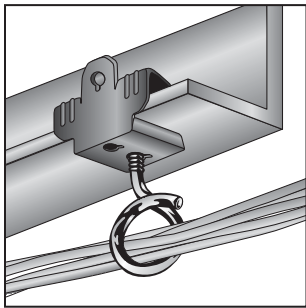

Static Load Limit: 100lbs

- Fast installation; fits beam flange to 1/2".
- Used with 1/4" and 3/8" threaded rod, "S" hooks, conduit hangers, electrical boxes, and #10-24 or 1/4"-20 bridle rings.
- Tapping 1/4"-20 bottom and back. Also #10-24 tapping on back.

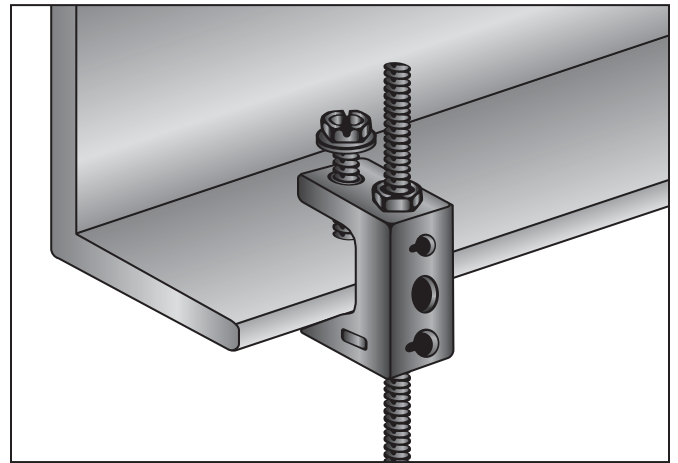

Static Load Limit

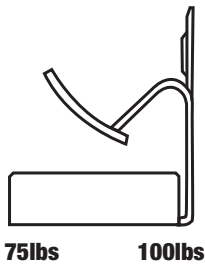

75lbs 100lbs

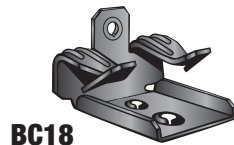

BC18

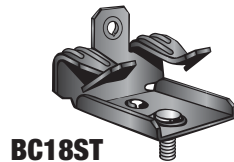

BC18ST

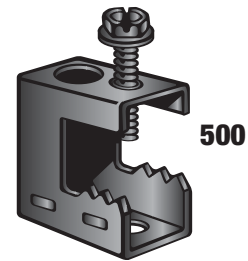

500

Flange Thickness	Part #	Std Pkg
Bottom & Back Tapped 1/4"-20		
1/8-1/4	BC18 ★	100
5/16-1/2	BC516 ★	100
9/16-3/4	BC916 ★	100
1/4"-20 x 3/8" Stud		
1/8-1/4	BC18ST	100
5/16-1/2	BC516ST	100
9/16-3/4	BC916ST	100

Accommodates		Part #	Std Pkg
Flange	Drop Rod		
Up to 1/2" Thick	1/4-3/8"	500	100

★ Made in USA

BEAM CLAMP TO CONDUIT HANGER ASSEMBLIES

Ultimate Static Load Limit:

25lbs Vertical Position
15lbs Horizontal Position

- Our #500 beam clamp with conduit hanger attached.

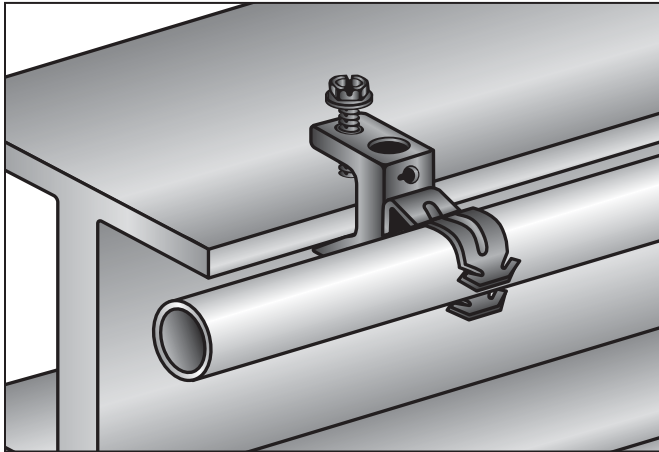

Static Load Limit:

100lbs Vertical Position
25lbs Horizontal Position

- Part #500 beam clamp with conduit hanger attached.

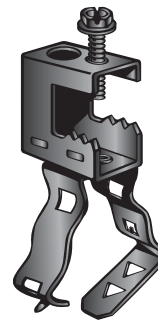
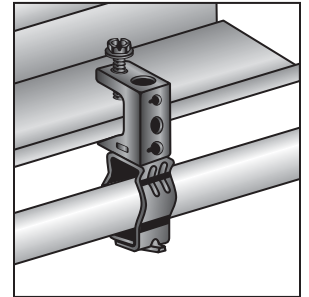

500KC1234

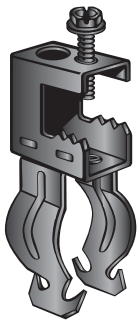

50050

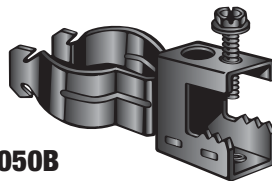

50050B

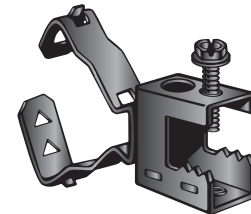

500KC1234B

BLACK CLAW

Fits EMT	Fits Rigid/IMC	Part #	Std Pkg
1/2	—	50050	100
3/4	1/2	50075	100
1	3/4	500100	100
1/2	—	50050B	100
3/4	1/2	50075B	100
1	3/4	500100B	100

Fits Conduit	Part #	Std Pkg
1/2 & 3/4	500KC1234	100
1	500KC1	100
1 1/4	500KC114	100
1 1/2	500KC112	100
2	500KC2	100
1/2 & 3/4	500KC1234B	100
1	500KC1B	100

FLANGE BEAM CLAMP

Static Load Limit: 200lbs

- Installed with hammer on bulb tees and beams.
- Clearance for 1/4" bolt in tab.



SFC18

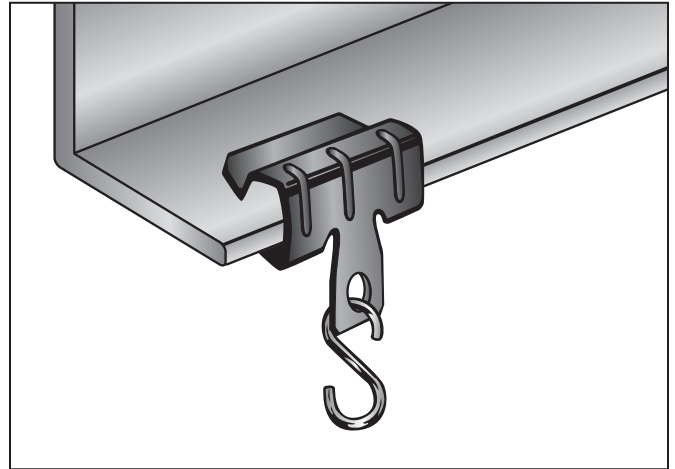

Flange Thickness	Part #	Std Pkg
1/8-1/4	SFC18 ★	100
5/16-1/2	SFC516 ★	100
9/16-3/4	SFC916 ★	100

★ Made in USA

Z PURLIN HANGER

Static Load Limit: 100lbs

- Installed without power tools.
- Compensates for angle of purlin.

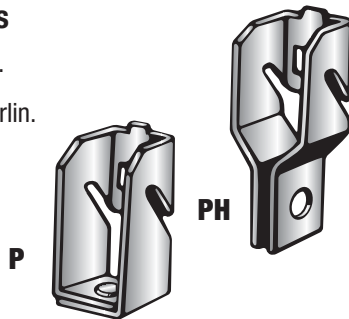

P

PH

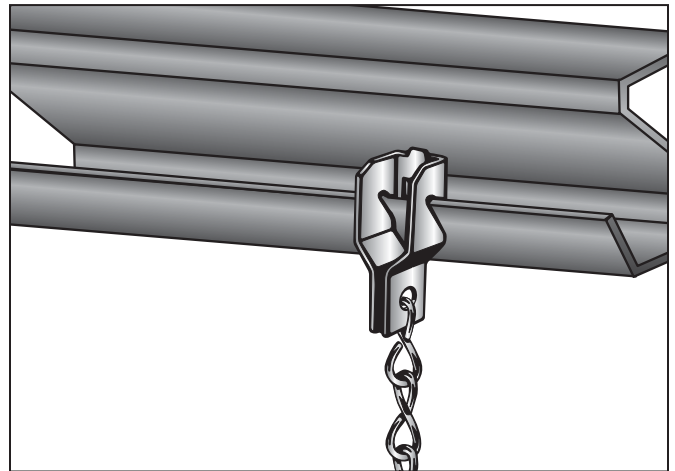

Description	Part #	Std Pkg
1/4" Bottom Hole	P ★	100
1/4" Hole for Wire, S-hooks, Perforated Strap and Jack Chain	PH ★	100

★ Made in USA

BLACK CLAW

Z PURLIN HANGER ASSEMBLIES

Static Load Limit: 100lbs

- Installed without power tools.
- Compensates for angle of purlin.

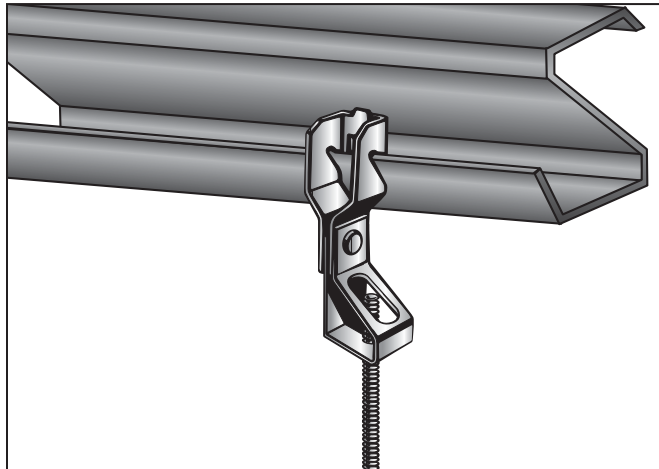

Ultimate Static Load Limit: 25lbs

- Installed without power tools.
- Compensates for angle of purlin.

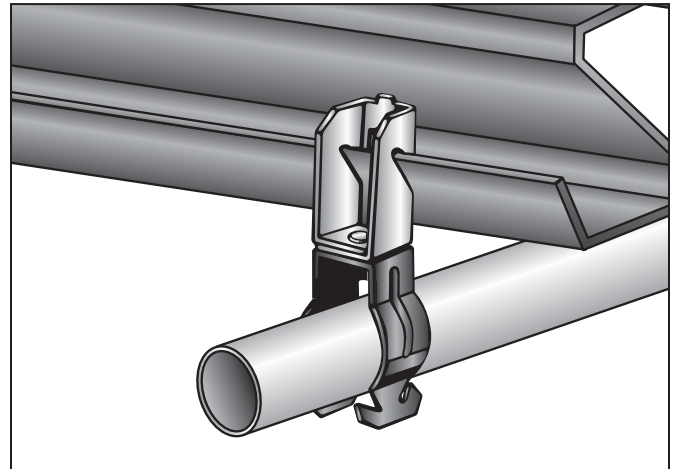

BLACK CLAW

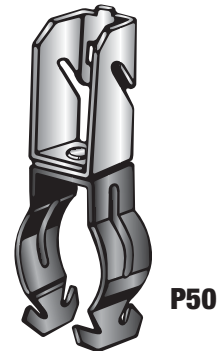

For Use With	Part #	Std Pkg
1/4" Threaded Rod	PH14T ★	100
3/8" Threaded Rod	PH38T ★	100
Up to 19 Strap	PHPSR ★	100

★ Made in USA

Description	Part #	Std Pkg
1/2" EMT	P50 ★	100
1/2" EMT or 3/4" Rigid	P75 ★	100
1" EMT or 3/4" Rigid	P100 ★	50

★ Made in USA

Z PURLIN HANGER ASSEMBLIES

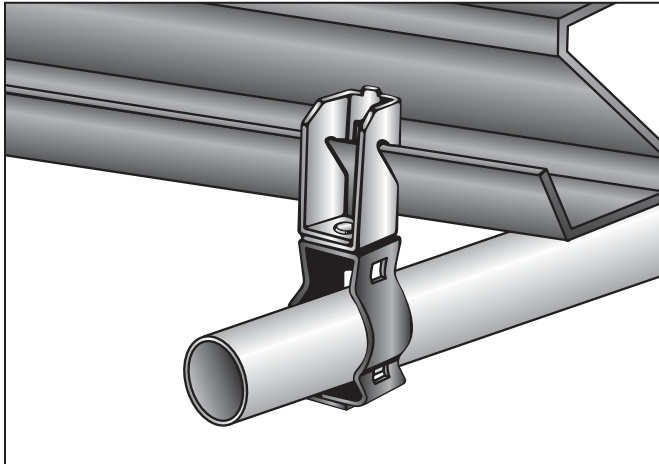

Static Load Limit: 100lbs

- Installed without power tools.
- Compensates for angle of purlin.

PKC1234

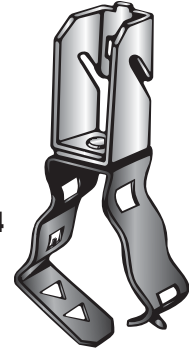

Description	Part #	Std Pkg
3/8" Conduit to Z Purlin	PKC38 ★	100
1/2" or 3/8" Conduit to Z Purlin	PKC1234 ★	100
1" Conduit to Z Purlin	PKC1 ★	100
1 1/4" Conduit to Z Purlin	PKC114 ★	50

★ Made in USA

Z PURLIN FLANGE HANGER

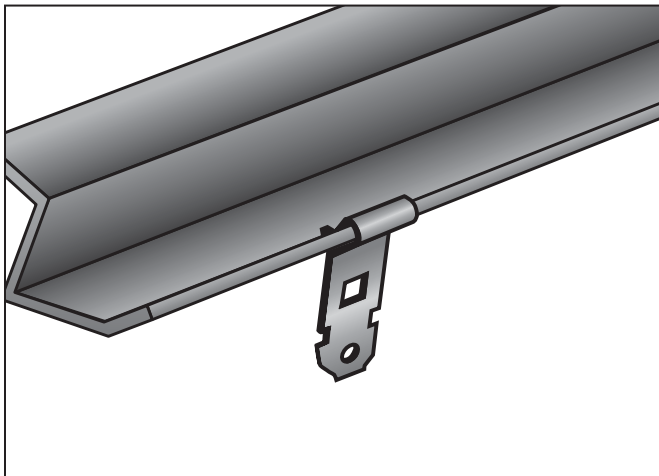

- Fits 1/16" to 1/4" thick Z Purlin (ABC25) or vertical flanges (VBC25).
- Clearance for 1/4" bolt.
- Accommodates tooling for floor installations.
- Assemblies available for ABC25 and VBC25. Please contact customer service.

Flange Thickness	For Use With	Part #	Std Pkg
1/16-1/4	Angled Z Purlin for S-Hooks, Perforated Strap and Wire	ABC25 ★	100
1/16-1/4	Vertical Flange for S-Hooks, Perforated Strap and Wire	VBC25 ★	100

★ Made in USA

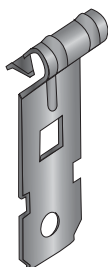

Static Load Limit: 100lbs
ABC25



Static Load Limit: 160lbs
VBC25

FLANGE HANGER

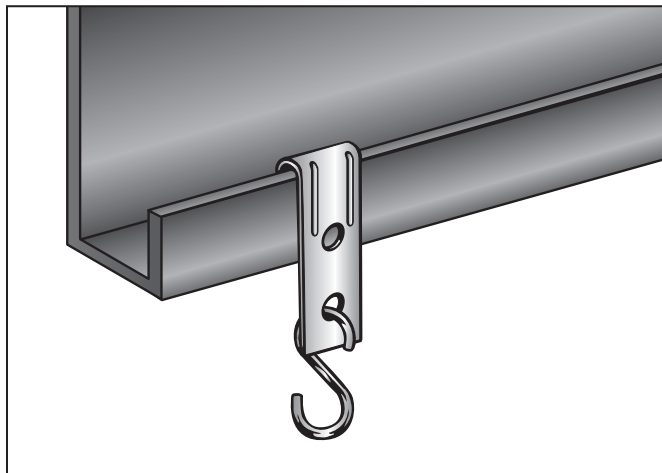

Static Load Limit: 160lbs

- Clearance for 1/4" bolt.



FH116

Flange Thickness	For Use With	Part #	Std Pkg
1/16–5/16	S-Hooks, Perforated Strap and Wire	FH116 ★	100
5/32–1/4	S-Hooks, Perforated Strap and Wire	FH532 ★	100

★ Made in USA

ROD TO FLANGE HANGER

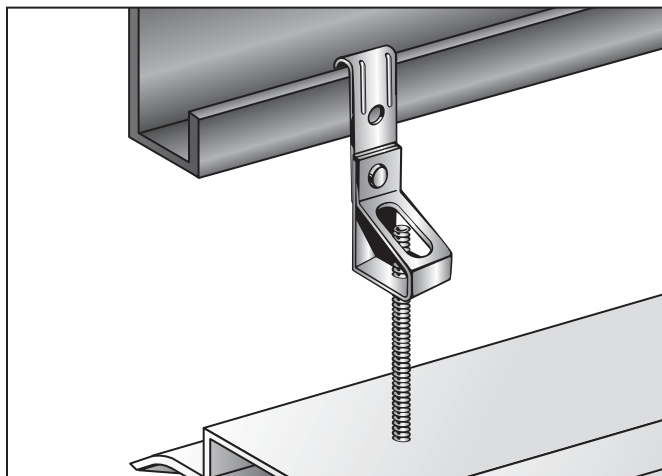

Static Load Capacity: 160lbs

- Suspends 1/4" or 3/8" threaded rod from vertical flange 1/16" to 1/4" thick.

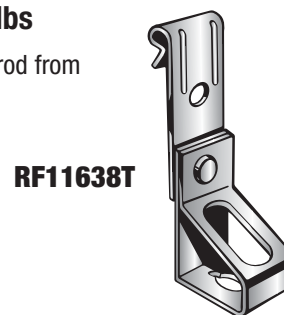

RF11638T

Flange Thickness	For Use With	Part #	Std Pkg
1/16–5/32	1/4" Threaded Rod	RF11614T ★	100
5/32–1/4	1/4" Threaded Rod	RF53214T ★	100
1/16–5/32	3/8" Threaded Rod	RF11638T ★	100
5/32–1/4	3/8" Threaded Rod	RF53238T ★	100

★ Made in USA

CONDUIT/CABLE SUPPORT

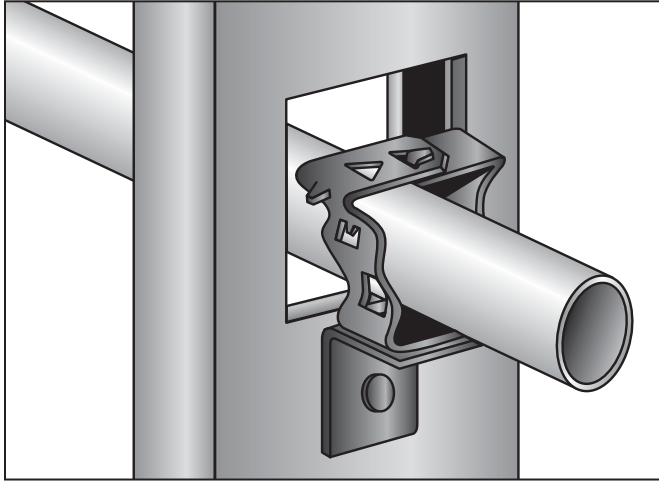

- Designed to secure horizontal runs of Rigid, EMT, AC, MC, BX or PVC through metal studs. 1/4" mounting hole on bracket.

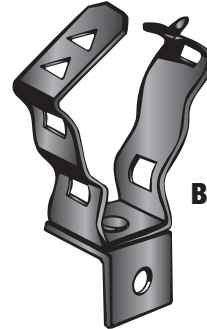

BAKC1234

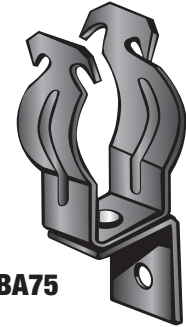

BA75

Fits Conduit	Part #	Std Pkg
3/8 or BX	BAKC38 ★	100
1/2 or 3/4	BAKC1234 ★	100
1/2 EMT	BA50 ★	100
3/4 EMT or 1/2 Rigid	BA75 ★	100

★ Made in USA

FLEXIBLE CONDUIT/CABLE FASTENER

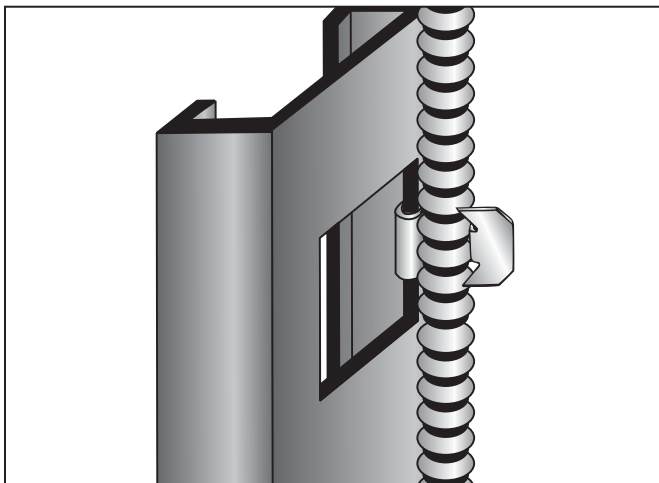

- Push clip attaches BX, MC or AC cable to metal studs.

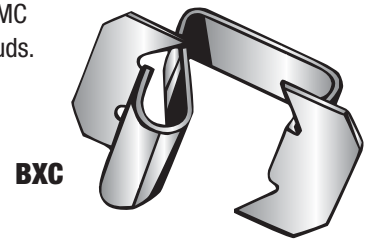

BXC

Description	Part #	Std Pkg
MC, AC or BX to Metal Stud	BXC ★	100

★ Made in USA

- Secures conduit to most metal studs.
- Installed using a hammer only.



SBX

Description	Part #	Std Pkg
MC or BX (12-2 thru 10-3) to Metal Studs	SBX ★	100

★ Made in USA

CONDUIT TO STUD SUPPORT

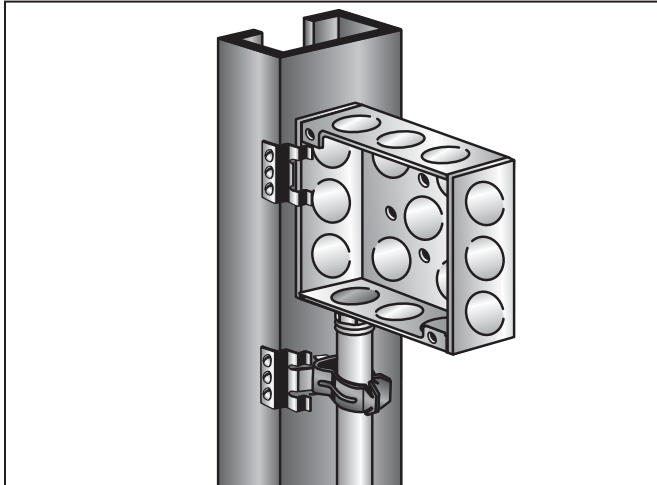

- Screw attached support for vertical runs of Rigid, EMT, or PVC to metal studs.
- See pages 214 and 244 for Far Side Box Support.

Fits EMT	Fits Rigid/IMC	Part #	Std Pkg
1/2	—	SS50 ★	100
3/4	1/2	SS75 ★	100
1	3/4	SS100 ★	100

Fits Conduit	Part #	Std Pkg
1/2 or 3/4	SSKC1234 ★	100
1	SSKC1 ★	100

★ Made in USA

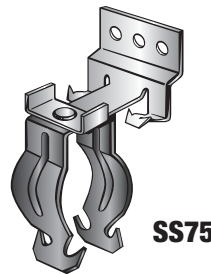

SS75

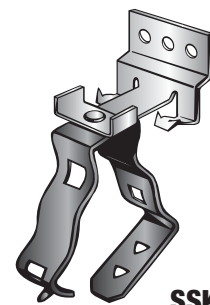

SSKC1234

BOX TO STUD FASTENER

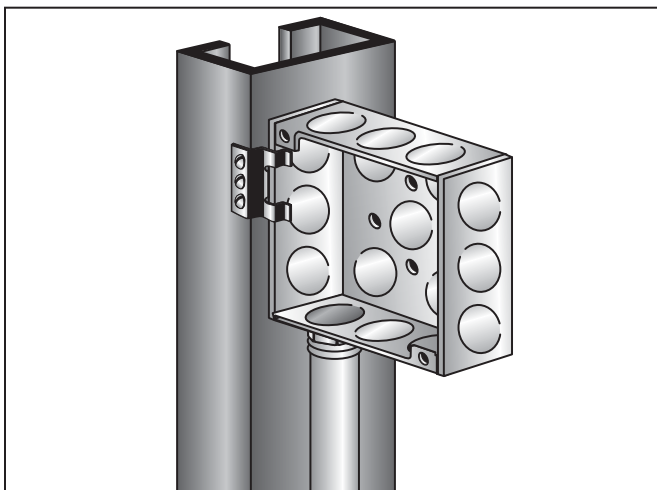

- Screw attached support for box and conduit. For use with either metal or wood studs.
- See pages 214 and 244 for Far Side Box Support.

Description	Part #	Std Pkg
Electrical Box Support Clip Secured with Self-Tapping Screws for Wood or Metal Studs	SS ★	100

★ Made in USA

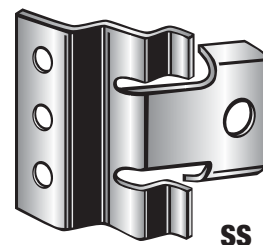

SS

BOX TO STUD SUPPORT

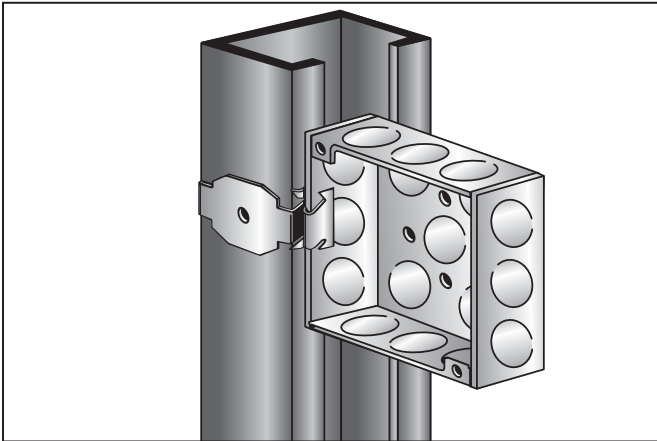

- Secures boxes to most metal studs.
- Installed using a hammer only.
- See pages 214 and 244 for Far Side Box Support.

Description	Part #	Std Pkg
Hammer Installed Electrical Box Support	S1900 ★	100

★ Made in USA

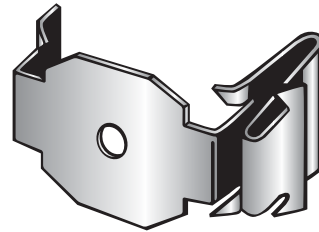

S1900

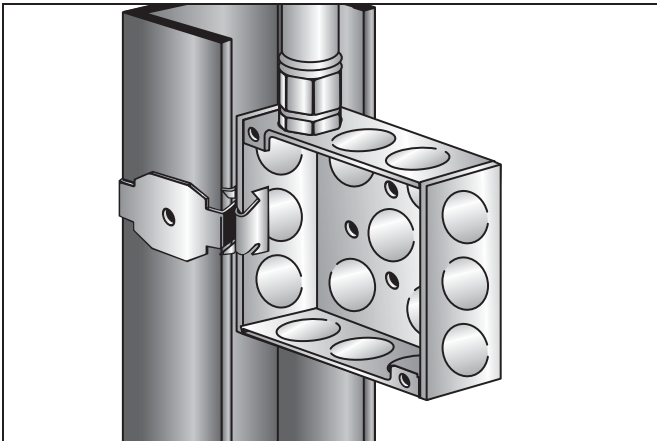

- Secures boxes to most metal studs.
- Series includes adjustable and preset versions.
- Installed using a hammer only.
- See pages 214 and 244 for Far Side Box Support.

Description	Part #	Std Pkg
Adjustable for 1/4" through 3/4" Drywall	SBC ★	100

★ Made in USA

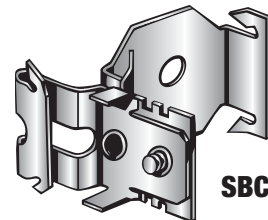

SBC

CONDUIT TO STUD FASTENER

- Designed to quickly secure vertical runs of Rigid, EMT, AC, MC, BX or PVC to metal studs.

Fits EMT	Fits Rigid/IMC	Part #	Std Pkg
1/2	—	SB50 ★	100
3/4	1/2	SB75 ★	100
1	3/4	SB100 ★	100

Fits Conduit	Part #	Std Pkg
3/8 or BX	SBKC38 ★	100
1/2 or 3/4	SBKC1234 ★	100
1	SBKC1 ★	100

★ Made in USA

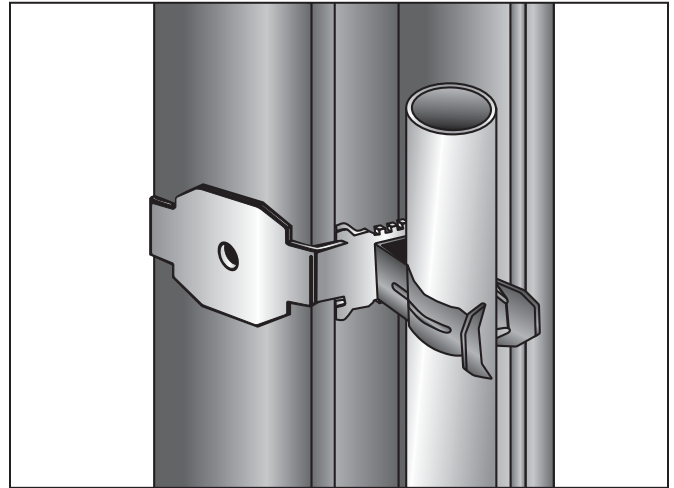
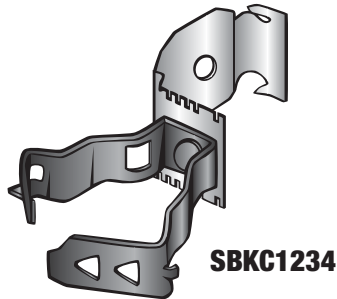

BLACK CLAW

FAR SIDE BOX SUPPORT

- Clips on electrical boxes for additional support.

Metal Stud Size	Part #	Std Pkg
2 1/2" thru 4", Sized by Bending at Premarked Lines	SBS ★	100
3 1/2	SBS3.5 ★	100
6	SBS6 ★	100

★ Made in USA

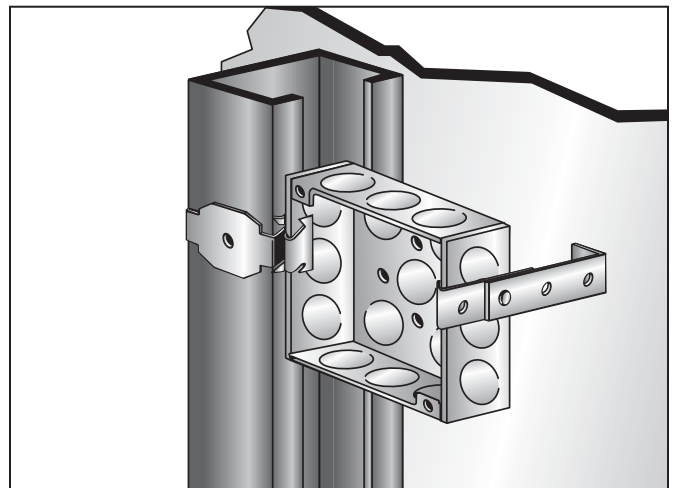
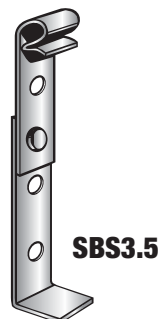
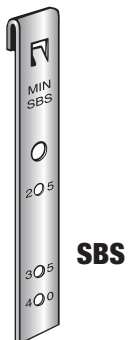

LIGHTING • TROFFER FASTENER

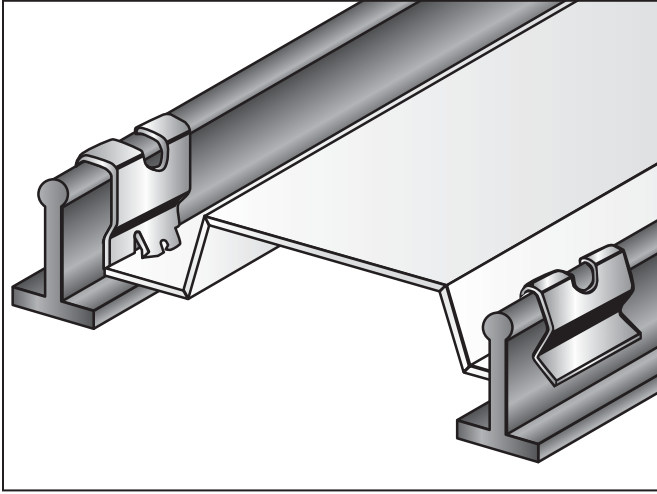

- Clip-on positive support for troffers and lay-in fixtures.
- Complies with 2011 NEC 410.36 (B) means of support.
- Fits round or rectangular head T-bars.

Description	Part #	Std Pkg
T-bar Clip for Troffers	FT ★	100

★ Made in USA

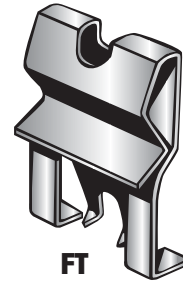

TWIST-ON T-BAR HANGER

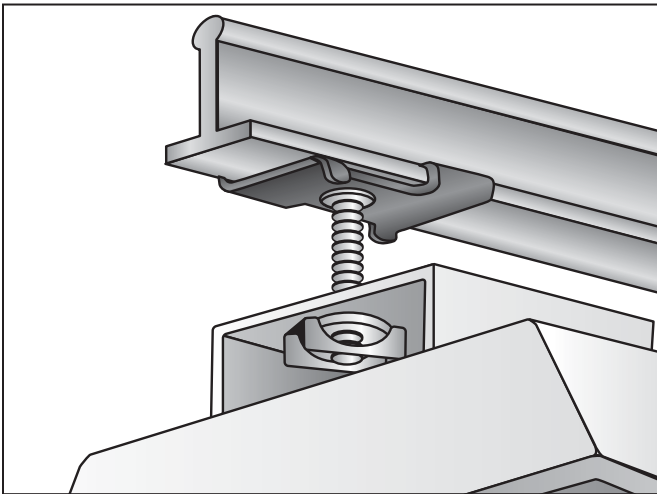

- Supports electrical fixtures to T-Bar $1\frac{5}{16}$ " wide.
- Assembled with 1" OD wing nut washer.
- $\frac{1}{4}$ "-20 stud $\frac{5}{8}$ " long.

Description	Part #	Std Pkg
Has $\frac{1}{4}$ "-20 x $\frac{5}{8}$ " Stud with Wing Nut Washer	SCT3	100

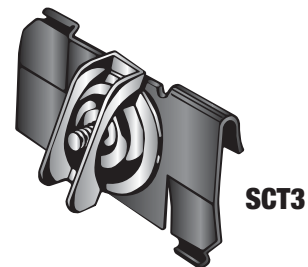

T-BAR FASTENERS

- Positive method of supporting conduit and outlet boxes above acoustical T-bar.

Description	Part #	Std Pkg
With 1/4"-20 Thread Impression	TBT ★	100
With Plain Hole	TB ★	100

Description	Part #	Std Pkg
With 1/4"-20 Thread Impression	TST ★	100
With Plain Hole	TS ★	100

★ Made in USA

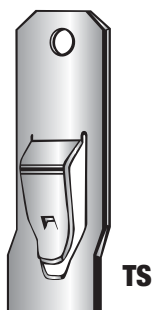
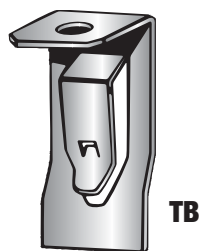
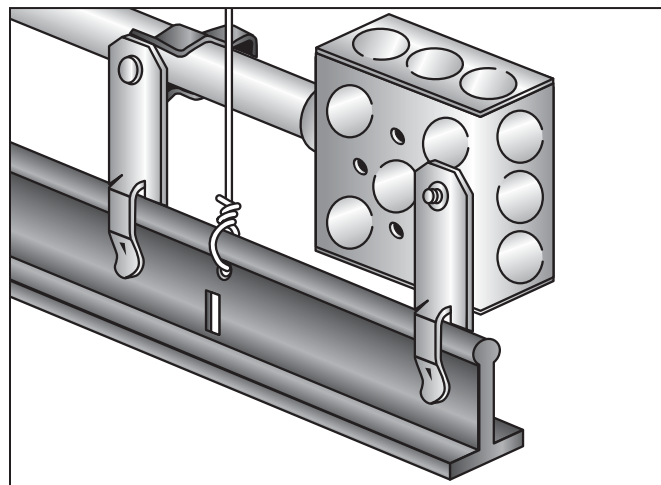

T-BAR FASTENERS

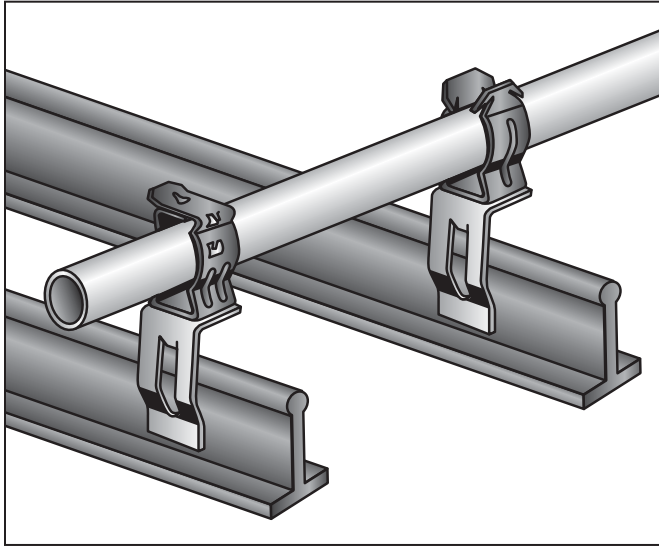

- Top mounted acoustical T-bar fastener. Riveted assembly fits 3/8" to 1" conduit.
- Supports boxes and conduit above T-bar.

Fits EMT	Fits Rigid/IMC	Part #	Std Pkg
1/2	—	TB50 ★	100
3/4	1/2	TB75 ★	100
1	3/4	TB100 ★	100

Fits Conduit	Part #	Std Pkg
3/8 or BX	TBKC38 ★	100
1/2, 3/4	TBKC1234 ★	100
1	TBKC1 ★	100

★ Made in USA



TB50

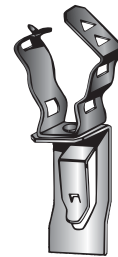

TBKC1234

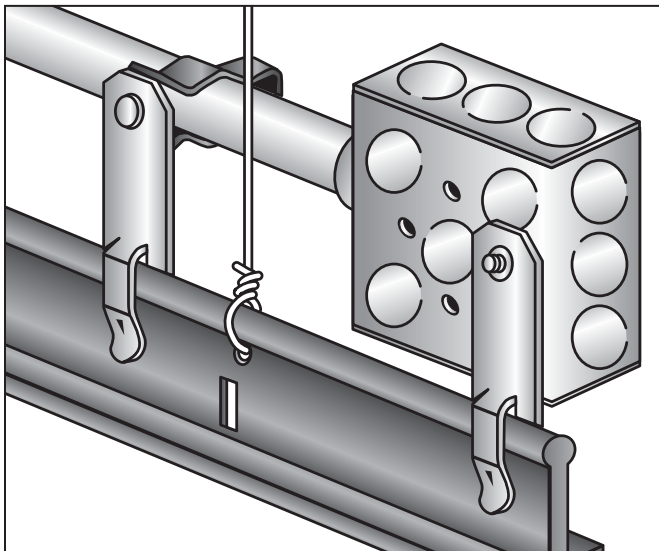

- Side mounted acoustical T-bar fastener. Riveted assembly fits 3/8" to 1" conduit.

Fits EMT	Fits Rigid/IMC	Part #	Std Pkg
1/2	—	TS50 ★	100
3/4	1/2	TS75 ★	100
1	3/4	TS100 ★	100

Fits Conduit	Part #	Std Pkg
3/8 or BX	TSKC38 ★	100
1/2, 3/4	TSKC1234 ★	100
1	TSKC1 ★	100

★ Made in USA



TSKC1



TS50

PLASTIC CABLE TIE FASTENER

- For securing data/com cables.
- Supports cable ties up to 5/16" in width.
- Secures directly to wall.



PCTF

Description	Part #	Std Pkg
Screw Directly to Wall	PCTF ★	100

★ Made in USA

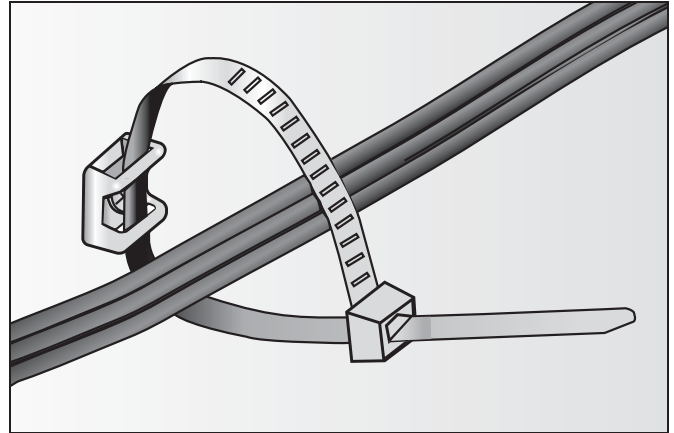

- For securing data/com cables to rod or flanges.
- Supports cable ties up to 5/16" in width.
- Plastic part made from quality UV stabilized and fire resistant material.



APSPCTF

Description	Part #	Std Pkg
#12 Wire thru 1/4" Rod and 1/8" thru 3/8" Flange	APSPCTF ★	100

★ Made in USA

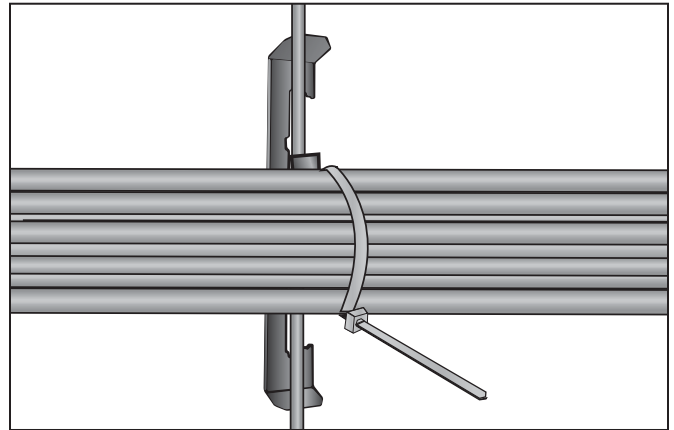

- For securing data/com cables to flanges.
- Supports cable ties up to 5/16" in width.
- Plastic part made from quality UV stabilized and fire resistant material.

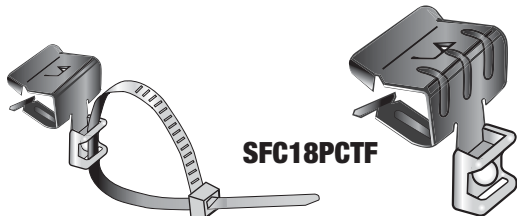

SFC18PCTF

Description	Part #	Std Pkg
1/8" thru 1/4" Flange	SFC18PCTF ★	100
5/16" thru 1/2" Flange	SFC516PCTF ★	100

★ Made in USA

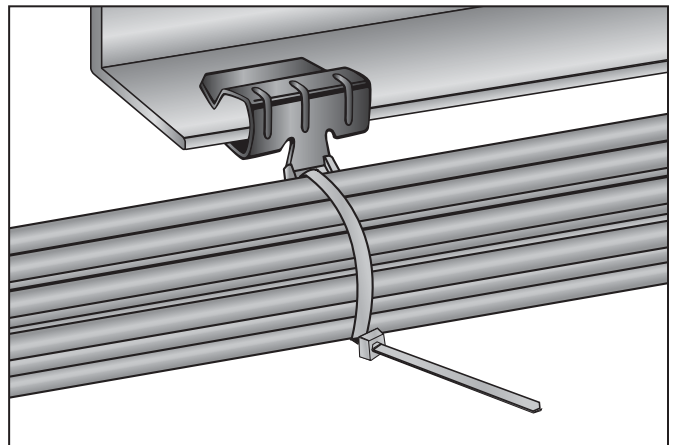

BOX TO BAR FASTENER

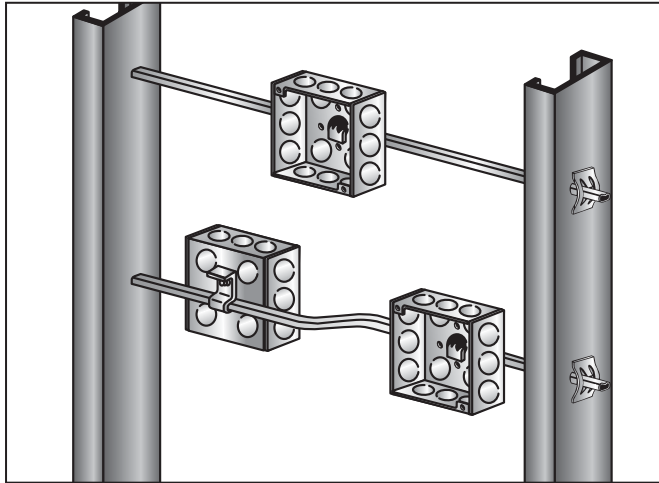

- Box to bar mounting clips.

Description	Part #	Std Pkg
Box Mounting Clip with Screw	BBC ★	100

★ Made in USA

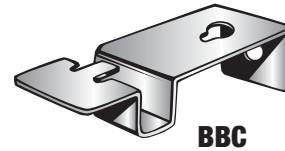

ROD HANGERS



R38T

Static Load Capacity: 160lbs

- Used for hanging rod.

For Use With	Part #	Std Pkg
1/4" or 3/8" Threaded Rod*	R1438N ★	100
1/4" Threaded Rod with Threaded Impression	R14T ★	100
3/8" Threaded Rod with Threaded Impression	R38T ★	100

*Nut required

★ Made in USA

Compatibility & Size Reference Charts

GALVANIC CORROSION COMPATIBILITY OF METALS

MATERIALS	Stainless Steel	Copper Plated Steel	Zinc Plated Steel	Aluminum	Spring Steel
Stainless Steel	Yes	No	Yes	Yes	Yes
Copper Plated Steel	No	Yes	No	No	No
Zinc Plated Steel	Yes	No	Yes	Yes	Yes
Aluminum	Yes	No	Yes	Yes	Yes
Spring Steel	Yes	No	Yes	Yes	Yes

RIGID STEEL CONDUIT (Heavy Wall Conduit)

Nominal Conduit Size	Outside Diameter (inches)	Nominal Inside Diameter (inches)	Min. Weight (lbs) per 100 ft w/Couplings Attached	Weight (lbs) of Conduit & Conductor per 100 ft
3/8	0.675	0.493	51.5	65.1
1/2	0.840	0.632	79.0	101.1
3/4	1.050	0.836	105.0	145.8
1	1.315	1.063	153.0	219.3
1 1/4	1.660	1.394	201.0	318.3
1 1/2	1.900	1.624	249.0	408.8
2	2.375	2.083	332.0	593.8
2 1/2	2.875	2.489	527.0	901.0
3	3.500	3.090	682.6	1259.0
3 1/2	4.000	3.570	831.0	1604.0
4	4.500	4.050	972.3	1967.0

RIGID ALUMINUM CONDUIT

- Dimensions taken from ANSI C80.3-1977.
- Conduit plus weight of heaviest conductor combination as specified by the National Electrical Code.

Nominal Conduit Size	Outside Diameter (inches)	Nominal Inside Diameter (inches)	Min. Weight (lbs) per 100 ft w/Couplings Attached	Weight (lbs) of Conduit & Conductor per 100 ft
1/2	0.840	0.632	27.4	49.5
3/4	1.050	0.836	36.4	84.3
1	1.315	1.063	53.0	130.3
1 1/4	1.660	1.394	69.6	212.3
1 1/2	1.900	1.624	82.2	269.8
2	2.375	2.083	115.7	401.8
2 1/2	2.875	2.489	182.5	579.0
3	3.500	3.090	238.9	626.3
3 1/2	4.000	3.570	287.7	1098.0
4	4.500	4.050	340.0	1364.0
5	5.563	5.073	465.4	2028.0
6	6.625	6.093	612.5	2870.0

Size Reference Charts

INTERMEDIATE METAL CONDUIT

Nominal Conduit Size	Outside Diameter (inches)	Nominal Inside Diameter (inches)	Min. Weight (lbs) per 100 ft w/Couplings Attached	Weight (lbs) of Conduit & Conductor per 100 ft
1/2	0.815	0.745	60.0	82.1
3/4	1.029	0.954	82.0	122.8
1	1.290	1.205	116.0	182.3
1 1/4	1.638	1.553	150.0	267.3
1 1/2	1.883	1.793	182.0	341.8
2	2.360	2.266	242.0	503.8
2 1/2	2.857	2.727	401.0	775.0
3	3.476	3.346	493.0	1069.0
3 1/2	3.971	3.841	573.0	1346.0
4	4.466	4.336	638.0	1632.0

ELECTRICAL METALLIC TUBING (EMT) (Thin Wall Conduit)

- Dimensions taken from ANSI C80.3-1977.
- Conduit plus weight of heaviest conductor combination as specified by the National Electrical Code.

Nominal Conduit Size	Outside Diameter (inches)	Nominal Inside Diameter (inches)	Min. Weight (lbs) per 100 ft w/Couplings Attached	Weight (lbs) of Conduit & Conductor per 100 ft
3/8	0.577	0.493	23.0	36.6
1/2	0.706	0.622	28.5	50.6
3/4	0.922	0.824	43.5	84.3
1	1.163	1.049	64.0	130.3
1 1/4	1.510	1.380	95.0	212.3
1 1/2	1.740	1.610	110.0	269.8
2	2.197	2.067	140.0	401.8
2 1/2	2.875	2.731	205.0	579.0
3	3.500	3.356	250.0	626.3
3 1/2	4.000	3.834	325.0	1098.0
4	4.500	4.334	370.0	1364.0

SCHEDULE 40 PVC PLASTIC PIPE

Nominal Pipe Size	Outside Diameter (inches)	Wall Thickness (inches)	Weight of Pipe (lbs/ft)	Weight of Water (lbs/ft)
1/8	.405	.068	.04	.02
1/4	.540	.088	.07	.04
3/8	.675	.091	.10	.08
1/2	.840	.109	.15	.1
3/4	1.050	.113	.2	.2
1	1.315	.133	.3	.4
1 1/4	1.660	.140	.4	.6
1 1/2	1.900	.145	.5	.9
2	2.375	.154	.6	1.4
2 1/2	2.875	.203	1.0	2.1
3	3.500	.216	1.3	3.2
3 1/2	4.000	.226	1.6	4.3
4	4.500	.237	1.9	5.5

DIMENSION ALL THREAD ROD (ATR)

- Dimensions taken from ANSI B1.1-1982 Unified Inch Screw Threads.
- All threads are UNCR series.
- Tabulated loads are based on an allowable tensile stress of 12000 psi (82.7 MPa) reduced by 25% resulting in 9000 psi (62 MPa). From ANSI/MSS SP-58, Table 3.

Nominal Size & Thread	Root Area		Design Load (SF=5)	
	in. ²	cm ²	lbs	kN
1/4 - 20	0.027	0.174	240	1.07
5/16 - 18	0.045	0.290	400	1.78
3/8 - 16	0.068	0.438	610	2.71

The Right Staple For The Job

The Impact Staples line offers residential insulated and non-insulated staples. Our most popular sizes of metal staples come with the standard dimple at the top—or try our “flat top” version. All plastic staples are made from high quality UV stabilization material for protection against harsh environments.

Minerallac Company's entire Impact Staples line is made in the U.S.A.

253 Packaging Options

254 Non-Insulated Metal Staples

255 Insulated Metal Staples

256-257 Insulated Plastic Staples



PACKAGING OPTIONS

Impact™ staples are packaged in conveniently sized individual boxes. Our most popular styles of Impact™ staples are available in boxes, kraft bags, jars or bulk packed in kegs and reusable plastic pails.



PLASTIC PAILS

Try Impact™ staples in our unique square-shaped pails. This weather-tight, sturdy, tip-resistant pail is easy to carry from job to job and has various other storage uses once the pail is empty.

SQUARE JARS

New square jars with finger indent for pouring ease.



INSULATED PLASTIC IMPACT™ STAPLES

- Provide secure mounting without damage to wire and cable.
- Zinc plated nails are designed to minimize wood splitting.
- Pre-positioned nails ensure quick installation, even in vertical and overhead positions.
- Box, bag, jars or bulk packed.
- Available in reusable plastic pails.
- Staples are made from high impact UV stabilized material for severe weather conditions.

NON-INSULATED & INSULATED METAL IMPACT™ STAPLES

- Leg design minimizes wood splitting.
- Staples are deburred and polished.
- Rust inhibitor applied for longer shelf life.
- Box, jars or bulk packed.
- Available in reusable plastic pails.
- Heavy-Duty 1" x 1/2" available to help eliminate "bending" when driven into hard wood.
- Flat Top" Version available for 1" x 1/2" and 1 1/4" x 9/16".
- Two types of insulated metal cable staples available for 1" x 1/2" and 1 1/4" x 9/16" sizes. PVC dipped and with Plastic Insulator, both in optic blue for high visibility.

CABLE STAPLES

Cable Size: 2 Conductor (#12 & #14) Romex® and other type NM cable.

Style (L x W)	Part #	Pkg Qty (Pcs)	Shipper (Pcs)
Standard 1" x 1/2"	I10A ★	Box of 100	10,000
	I10C ★	Box of 500	5,000
	I10G ★	Jar of 500	3,000
	I10R ★	Pail of 5,000	5,000
Standard HEAVY DUTY 1" x 1/2"	I10HA ★	Box of 100	10,000
	I10HC ★	Box of 500	5,000
	I10HG ★	Jar of 500	3,000
	I10HR ★	Pail of 5,000	5,000
Flat Top HEAVY DUTY 1" x 1/2"	I10HFA ★	Box of 100	10,000
	I10HFC ★	Box of 500	5,000
	I10HFG ★	Jar of 500	3,000
	I10HFR ★	Pail of 5,000	5,000

Cable Size: S.E.U. 6/3 Cable

L x W	Part #	Pkg Qty (Pcs)	Shipper (Pcs)
1 5/16" x 3/4"	I13A ★	Box of 100	2,000

Cable Size: S.E.U. 2/3 Cable

L x W	Part #	Pkg Qty (Pcs)	Shipper (Pcs)
1 1/2" x 1"	I15A ★	Box of 100	2,000

★ Made in USA

SERVICE ENTRANCE STAPLES

Cable Size: 6/3 S.E. 8-3 BX Range Cords

L x W	Part #	Pkg Qty (Pcs)	Shipper (Pcs)
1 3/8" x 1 3/16"	ISE13A ★	Box of 100	2,000

Cable Size: 4/3 S.E.R. 2/3 S.E. 3/4" EMT

L x W	Part #	Pkg Qty (Pcs)	Shipper (Pcs)
1 7/16" x 1 1/16"	ISE14A ★	Box of 100	1,000

Cable Size: 2/0 S.E., 1" EMT

L x W	Part #	Pkg Qty (Pcs)	Shipper (Pcs)
1 7/8" x 1 11/32"	ISE18U ★	Box of 50	1,000

★ Made in USA

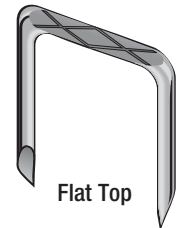
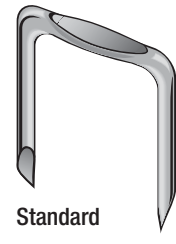
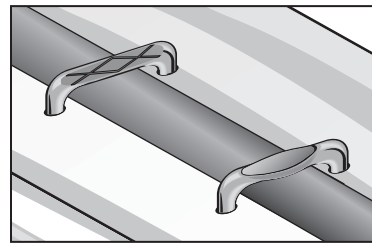

Cable Size: 3 Conductor (#10, #12 & #14) Romex®, BX, MC and other cable.

Style (L x W)	Part #	Pkg Qty (Pcs)	Shipper (Pcs)
Standard 1 1/4" x 9/16"	I12A ★	Box of 100	5,000
	I12C ★	Box of 500	5,000
	I12G ★	Jar of 500	3,000
	I12R ★	Pail of 5,000	5,000
	I12S ★	Pail of 7,500	7,500
Flat Top 1 1/4" x 9/16"	I12FA ★	Box of 100	5,000
	I12FC ★	Box of 500	5,000
	I12FG ★	Jar of 500	3,000
	I12FR ★	Pail of 5,000	5,000

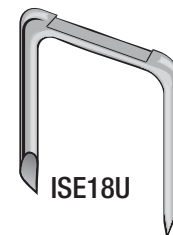

Cable Size: 2/3 BX, 1" EMT, 1" Greenfield, 2/3 SER

L x W	Part #	Pkg Qty (Pcs)	Shipper (Pcs)
2 1/4" x 1 3/16"	ISE22U ★	Box of 50	1,000

Cable Size: 4/0 S.E. Greenfield, Large BX, Romex®, Tubing

L x W	Part #	Pkg Qty (Pcs)	Shipper (Pcs)
2 1/8" x 1 5/8"	ISE23U ★	Box of 50	500

PLASTIC INSULATOR CABLE STAPLES



Standard

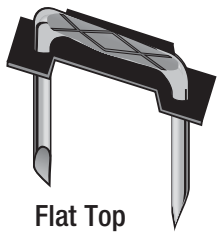

Flat Top

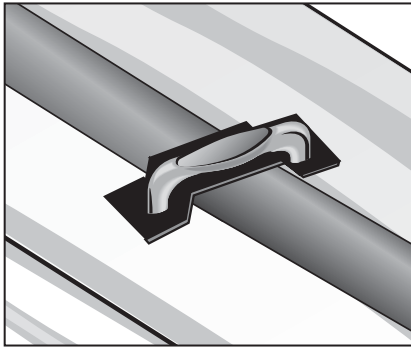

- Highly visible optic blue plastic insulator.
- Standard or flat top staple style.
- Packed in boxes and square plastic pails.

Cable Size: 2 Conductor (#12 & #14) Romex®, and other type NM cable.

Style and Size (L x W)	Part #	Pkg Qty (Pcs)	Shipper (Pcs)
Standard 1" x 1/2"	IPN1A ★	Box of 100	2,000
	IPN1C ★	Box of 500	5,000
	IPN1R ★	Pail of 5,000	5,000
Flat Top HEAVY DUTY 1" x 1/2"	IPN1HFA ★	Box of 100	2,000
	IPN1HFC ★	Box of 500	5,000

Cable Size: 3 Conductor (#10, #12 & #14) Romex®, BX, MC and other cable.

Style and Size (L x W)	Part #	Pkg Qty (Pcs)	Shipper (Pcs)
Standard 1 1/4" x 9/16"	IPN2A ★	Box of 100	2,000
	IPN2C ★	Box of 500	5,000
	IPN2R ★	Pail of 5,000	5,000
Flat Top 1 1/4" x 9/16"	IPN2FA ★	Box of 100	2,000
	IPN2FC ★	Box of 500	2,500
	IPN2FR ★	Pail of 5,000	5,000

★ Made in USA

PVC DIPPED CABLE STAPLES



IPVC1

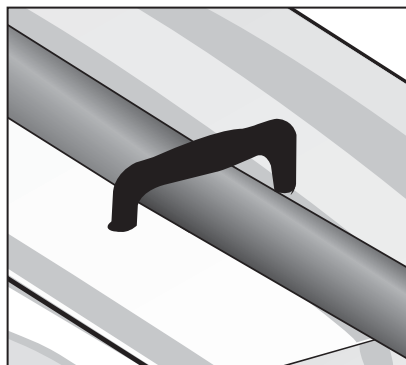

- Top of staple dipped in high impact hot melt PVC.
- Highly visible optic blue.
- Packed in boxes, jars and square plastic pails.

Cable Size: 2 Conductor (#12 & #14) Romex®, and other type NM cable.

Style and Size (L x W)	Part #	Pkg Qty (Pcs)	Shipper (Pcs)
HEAVY DUTY 1" x 1/2"	IPVC1HA ★	Box of 100	2,000
	IPVC1HC ★	Box of 500	5,000
	IPVC1HF ★	Jar of 350	2,100
	IPVC1HR ★	Pail of 5,000	5,000

Cable Size: 3 Conductor (#10, #12 & #14) Romex®, BX, MC and other cable.

Size (L x W)	Part #	Pkg Qty (Pcs)	Shipper (Pcs)
1 1/4" x 9/16"	IPVC2A ★	Box of 100	2,000
	IPVC2C ★	Box of 500	5,000
	IPVC2F ★	Jar of 350	2,100
	IPVC2R ★	Pail of 5,000	5,000

★ Made in USA

PLASTIC CABLE STAPLES

Cable Size: 2 & 3-wire NM cable up to #12, 2-wire UF cable up to #12 and other cable up to 1/2" wide.

Color	Part #	Pkg Qty (Pcs)	Shipper (Pcs)
White	IPS50A ★	Box of 100	1,000
	IPS50C ★	Box of 500	2,500
	IPS50E ★	Jar of 200	1,200
	IPS50P ★	Pail of 2,000	2,000
	IPS50K ★	Kraft Bag of 500	2,500

Cable Size: 2-wire NM and UF cable up to #8, 3-wire UF cable up to #12 and other cable up to 3/4" wide.

Color	Part #	Pkg Qty (Pcs)	Shipper (Pcs)
White	IPS75A ★	Box of 100	1,000
	IPS75C ★	Box of 500	2,500
	IPS75D ★	Jar of 150	900
	IPS75P ★	Pail of 2,000	2,000
	IPS75L ★	Kraft Bag of 500	2,500

★ Made in USA

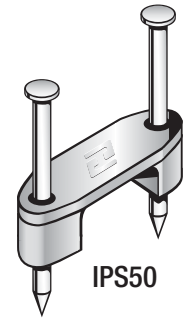
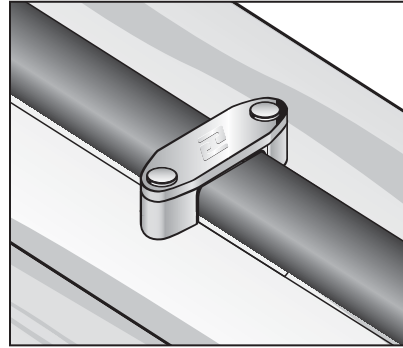

IPS50

- Our top selling insulated staples.
- For 1/2" and 3/4" wide single cables.
- UL Listed.
- Made from UV stabilized high impact plastic.

STACKING CABLE STAPLES

Cable Size: For stacking two 2-wire #14 or #12 NM cable.

Color	Part #	Pkg Qty (Pcs)	Shipper (Pcs)
Tan	IPS502 ★	Box of 50	1,000

Cable Size: For stacking three 2-wire or a 2-wire and a 3-wire #4 and #12 NM cable.

Color	Part #	Pkg Qty (Pcs)	Shipper (Pcs)
Gray	IPS503 ★	Box of 50	1,000

Cable Size: For stacking two 3-wire or four 2-wire #14 or #12 NM cable.

Color	Part #	Pkg Qty (Pcs)	Shipper (Pcs)
White	IPS504 ★	Box of 50	500

★ Made in USA

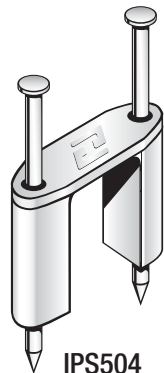
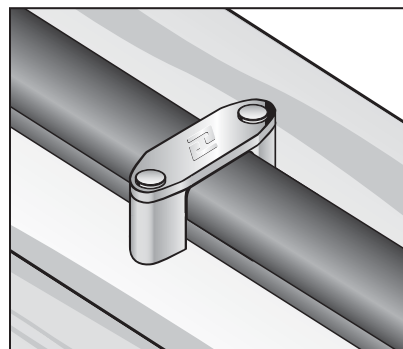

IPS504

- For stacking multiple 1/2" wide cables.
- Made from UV stabilized high impact plastic.

SERVICE ENTRANCE STAPLES • STYLE SER



ISER40

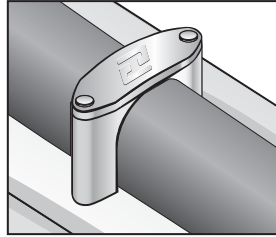

- All staples are UV stabilized for severe weather conditions.
- Zinc plated nails made from high carbon steel for strength and durability.

Cable Size: #6 Type SE, Style SER, ½" EMT (.718" Diameter)

Color	Part #	Pkg Qty (Pcs)	Shipper (Pcs)
Gray	ISER10 ★	Box of 50	500

Cable Size: #2 Type SE, Style SER, ¾" EMT (.937" Diameter)

Color	Part #	Pkg Qty (Pcs)	Shipper (Pcs)
Gray	ISER20 ★	Box of 25	250

Cable Size: #2/0 Type SE, Style SER, 1" EMT (1.160" Diameter)

Color	Part #	Pkg Qty (Pcs)	Shipper (Pcs)
Gray	ISER30 ★	Box of 25	250

Cable Size: #4/0 Type SE, Style SER, (1.438" Diameter)

Color	Part #	Pkg Qty (Pcs)	Shipper (Pcs)
Gray	ISER40 ★	Box of 10	100

★ Made in USA

BELL & THERMOSTAT STAPLES

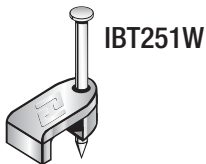

IBT251W

- Available in black and white.
- All staples are UV stabilized for severe weather conditions.
- Zinc plated nails made from high carbon steel for strength and durability.

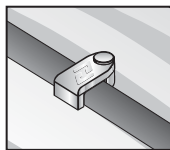

Cable Size: ¼" 1-Nail

Color	Part #	Pkg Qty (Pcs)	Shipper (Pcs)
Black	IBT251B ★	Box of 100	1,000
White	IBT251W ★	Box of 100	1,000

★ Made in USA

SERVICE ENTRANCE STAPLES • STYLE SEU

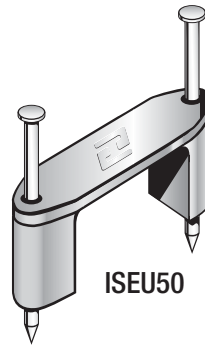

ISEU50

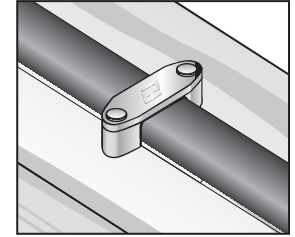

- All staples are UV stabilized for severe weather conditions.
- Zinc plated nails made from high carbon steel for strength & durability.

Cable Size: #6 Type SE, Style SEU, (.437" x .750")

Color	Part #	Pkg Qty (Pcs)	Shipper (Pcs)
Gray	ISEU50 ★	Box of 50	500

Cable Size: #2 Type SE, Style SEU, (.550" x .972")

Color	Part #	Pkg Qty (Pcs)	Shipper (Pcs)
Gray	ISEU60 ★	Box of 50	500

Cable Size: #2/0 Type SE, Style SEU, (.775" x 1.265")

Color	Part #	Pkg Qty (Pcs)	Shipper (Pcs)
Gray	ISEU70 ★	Box of 25	500

Cable Size: #4/0 Type SE, Style SEU, (.855" x 1.500")

Color	Part #	Pkg Qty (Pcs)	Shipper (Pcs)
Gray	ISEU80 ★	Box of 25	250

NON-METALLIC SHEATHED CABLE STAPLES

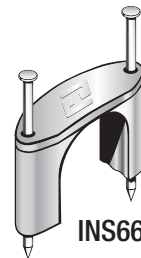

INS66

- All staples are UV stabilized for severe weather conditions.
- Zinc plated nails made from high carbon steel for strength and durability.

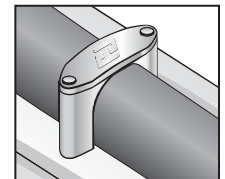

Cable Size: For 3-wire #8 and #6 NM cable and other cable up to 2 1/32" wide.

Color	Part #	Pkg Qty (Pcs)	Shipper (Pcs)
Gray	INS66 ★	Box of 100	1,000

Staples, Nails and Wire

Redmore offers popular sizes of utility staples with diamond or cut points in bright wire, mechanical galvanized or copperclad finishes.

Minerallac Company's entire Redmore® line is made in the U.S.A.

259 General Product Information

260–264 Diamond Point Staples

265–266 Cut Point Staples

267 Nails

268 Standard Gauge Wire Chart



MANUFACTURING MATERIALS

Bright Wire – Bright Wire has no finish. Parts made from this material are recommended for applications where there is no issue with respect to corrosion as a result of exposure to harsh or outdoor environments.

Pre-Galvanized – Mill or Pre-Galvanized wire has a factory bonded zinc coating applied to a bright wire base. Parts made from this material are afforded a minimum zinc protection on uncut surfaces of .000159.

Copperclad – Copperclad wire has a factory bonding of copper material to a bright wire base. This copperclad wire provides excellent corrosion protection for parts made from it and is preferred over coatings. The copper thickness is a minimum of 6% of the wire radius. This finish provides .00349 to .00739 thickness depending on the wire diameter.

FINISHES

Electro-Zinc Plated – Bright wire parts are electro-zinc plated after forming. This plating provides a minimum zinc coating of .000159 applied to all surfaces.

Mechanical Galvanized – We coat our staples to Class 50, Type 1. Which is .0029 of zinc and is 13 times greater in thickness than conventional electro-zinc coatings mechanical galvanized finish will withstand 300 hours to red rust in a 5% neutral salt spray test.

MANUFACTURING OPTIONS

Additional sizes and styles of Redmore® products are available. Please contact customer service.

Staples – Redmore® Staples are produced with Diamond (rolled) points, Cut (slash points) or Flat (chisel) points. Contact sales for information and pricing on Flat Point Staples.

Most staples are produced with smooth wire, but our serrated diamond point or cut point staples are manufactured with grooves in the legs of the staples to increase holding power and reduce back-out problems.

Nails – We offer common nails in a variety of wire gauges in both hot-dipped galvanized and copperclad. We also offer roofing nails in two different sizes and a variety of pole marking nails including pole class, pole height, dating and delta inspection.

PACKAGING OPTIONS

Special Packaging/Label Options – Redmore® is geared to customer service. Two available services include special packaging and custom labeling. Contact sales to discuss packaging options.

Special Size Requirements – We carry a large quantity of the most popular sizes. We also carry many sizes not shown in our catalog. If we do not carry the size you require, as a manufacturer, we have the capability to produce custom sizes if sufficient quantities are needed. Please contact sales to discuss specifications, production and plating minimums, set up charges and freight costs.

Bulk Packaging – All cut point staples are packed economically in bulk (loose staples packed in 50 lb. kegs.) Bright wire diamond point staples are also available packed in bulk.

Wire Size

Wire Diameter	Part # Letter	Gauge	Inches
.114	C	—	—
.120	E	11	—
.144	I	—	—
.148	K	9	—
.162	Q	8	—
.187	S	6	3/16"
.250	W	—	—

STAPLE MEASURING GUIDE

The following measurements correspond to those found at the top of the following pages:

Dimension A (Overall Length) – Measurement taken from top of staple to it's tip.

Dimension B (Inside Spread) – Measurement taken towards top of staple as indicated.

Dimension C (Wire Diameter) – Diameter of wire used in forming the staple. (See Wire Guide Reference on page 268.)

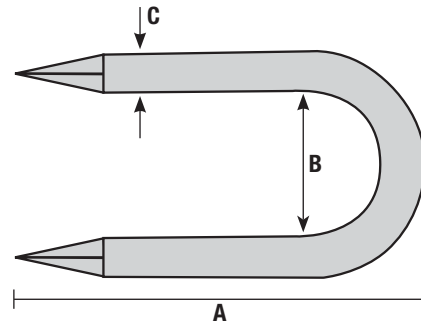

Diamond (Rolled) Point Staple

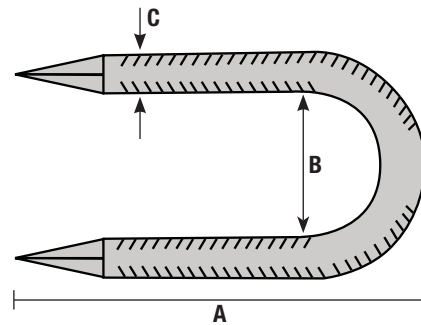

Serrated Diamond (Rolled) Point Staple



SQUARE WIRE BARBED STAPLES • BOX PACK

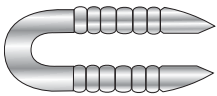

- Pounds per box is approximate and can vary + or – 10% depending on variances in wire weights and tolerances of staples during manufacture.

A	B	C				
Overall Length	Inside Spread	Wire Diameter	Part #	Pcs/Box	Boxes/ Carton	Approximate lbs/Box
Mechanical Galvanized						
1½	⅜	.131	CG1538M(B) ★ ♡	350	5	5.0
2	⅜	.131	CG2038M(B) ★ ♡	260	5	5.0
2	⅝	.165	CG2063T(B) ★ ♡	160	5	5.0
3	1⅛	.218	CG3090N(B)* ★ ♡	60	5	5.0
Copperclad**						
1½	⅜	.140	CC1538P(B) ★	300	5	4.8

*MOQ (Minimum Order Quantity)

**Due to volatility of copper market, please contact customer service for pricing.

★ Made in USA

♡ Harsh Environment Product

For 50lb keg packaging, contact customer service for quantities and availability.

BRIGHT WIRE DIAMOND POINT STAPLES • BOX PACK

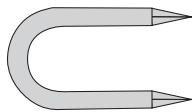

- Pounds per box is approximate and can vary + or – 10% depending on variances in wire weights and tolerances of staples during manufacture.

A	B	C				
Overall Length	Inside Spread	Wire Diameter	Part #	Pcs/Box	Boxes/ Carton	Approximate lbs/Box
1½	¾	.148	DB1538K ★	100	10	1.28
1½	½	.148	DB1550K ★	100	10	1.30
1¾	¾	.148	DB1738K ★	100	10	1.58
1¾	⅝	.162	DB1763Q ★	100	10	1.92
2	½	.162	DB2050Q ★	100	10	2.13
2	⅝	.162	DB2063Q ★	100	10	2.22
2	⅝	.187	DB2063S ★	100	10	2.82
2	¾	.187	DB2075S ★	100	10	2.89
2½	¾	.187	DB2575S ★	100	10	3.64
2½	29/32	.187	DB2588S ★	100	10	3.77
2½	1¼	.187	DB2592S ★	100	10	3.90
3	¾	.187	DB3075S ★	100	5	4.50
3	1⅛	.250	DB3090W ★	100	5	7.52
3	1½	.250	DB3095W ★	100	5	7.84
3	1¾	.250	DB3097W ★	100	5	8.16
4	1¾	.250	DB4097W* ★	50	5	5.27

*MOQ (Minimum Order Quantity)

★ Made in USA

For 50lb keg packaging, contact customer service for quantities and availability.

BRIGHT WIRE DIAMOND POINT STAPLES • BULK PACK • 50LB KEG

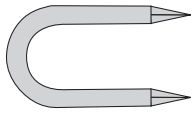

- Pounds per box is approximate and can vary + or – 10% depending on variances in wire weights and tolerances of staples during manufacture.

A	B	C	Part #	Approximate Pcs/50 lb Keg	Approximate Pcs/lb
Overall Length	Inside Spread	Wire Diameter			
1½	¾	.148	DB1538K-B50 ★	3900	78
1½	½	.148	DB1550K-B50 ★	3850	77
1¾	¾	.148	DB1738K-B50 ★	3250	65
1¾	⅝	.162	DB1763Q-B50 ★	2600	52
2	¾	.120	DB2038E-B50 ★	4150	83
2	½	.162	DB2050Q-B50 ★	2350	47
2	⅝	.162	DB2063Q-B50 ★	2250	45
2	⅝	.187	DB2063S-B50 ★	1750	35
2	¾	.187	DB2075S-B50 ★	1750	35
2½	¾	.187	DB2575S-B50 ★	1400	28
2½	²⁹ / ₃₂	.187	DB2588S-B50 ★	1350	27
2½	1¼	.187	DB2592S-B50 ★	1250	25
3	¾	.187	DB3075S-B50 ★	1100	22
3	1⅙	.250	DB3090W-B50 ★	650	13
3	1½	.250	DB3095W-B50 ★	650	13
3	1¾	.250	DB3097W-B50 ★	600	12
4	1¼	.250	DB4092W-B50* ★	500	10

*MOQ (Minimum Order Quantity)

★ Made in USA

ELECTRO-ZINC DIAMOND POINT STAPLES • BOX PACK

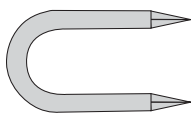

- Pounds per box is approximate and can vary + or – 10% depending on variances in wire weights and tolerances of staples during manufacture.

A	B	C	Part #	Pcs/Box	Boxes/ Carton	Approximate lbs/Box
Overall Length	Inside Spread	Wire Diameter				
1¾	¾	.148	DZ1738K ★	100	10	1.55
2	⅝	.162	DZ2063Q ★	100	10	2.18
2	⅝	.187	DZ2063S* ★	100	10	2.91
3	1⅙	.250	DZ3090W* ★	100	5	7.47

*MOQ (Minimum Order Quantity)

★ Made in USA

GALVANIZED DIAMOND POINT STAPLES • BOX PACK

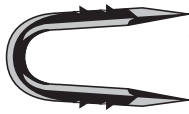
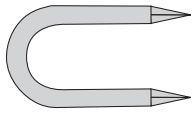

**Double Barbed
DG3090W(H)

- Pounds per box is approximate and can vary + or – 10% depending on variances in wire weights and tolerances of staples during manufacture.

A	B	C	Part #	Pcs/Box	Boxes/ Carton	Approximate lbs/Box
Overall Length	Inside Spread	Wire Diameter				
1½	¾	.148	DG1538K ★ ♡	100	10	1.38
1½	¾	.120	DG1575E ★ ♡	100	10	1.00
2	½	.162	DG2050Q ★ ♡	100	10	2.22
2	⅝	.162	DG2063Q ★ ♡	100	10	2.25
2	1⅙	.187	DG2090S* ★ ♡	100	10	3.14
2½	29/32	.187	DG2588S ★ ♡	100	10	3.85
2½	1⅙	.187	DG2590S* ★ ♡	100	10	3.85
3	1⅙	.250	DG3090W ★ ♡	100	5	7.96
3	1⅙	.250	DG3090W(H)** ★ ♡	100	5	7.69
3	1¾	.250	DG3097W* ★ ♡	100	5	8.50
3½	1¾	.250	DG3597W* ★ ♡	50	5	4.76

*MOQ (Minimum Order Quantity)

**Double barbed

★ Made in USA

♡ Harsh Environment Product

COPPERCLAD DIAMOND POINT STAPLES • BOX PACK

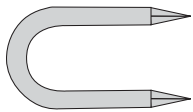

- Due to volatility of copper market, please contact customer service for pricing.

- Pounds per box is approximate and can vary + or – 10% depending on variances in wire weights and tolerances of staples during manufacture.

A	B	C	Part #	Pcs/Box	Boxes/ Carton	Approximate lbs/Box
Overall Length	Inside Spread	Wire Diameter				
1	¼	.114	DC1025C ★	500	10	2.50
1¼	¼	.114	DC1225C ★	500	10	3.21
1½	⅙	.144	DC1531I ★	500	5	6.20
1¾	⅜	.144	DC1738I ★	500	5	7.46
2	½	.162	DC2050Q ★	100	10	2.17
2	⅝	.162	DC2063Q ★	100	10	2.22
2	⅝	.187	DC2063S ★	100	10	2.89

★ Made in USA

For 50lb keg packaging, contact customer service for quantities and availability.

DRIVE STOP® DIAMOND POINT STAPLES • BOX PACK

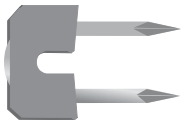

All Drive Stop® staples fitting #4 wire have a grey Drive Stop™.

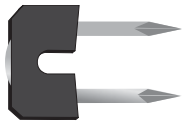

All Drive Stop® staples fitting #6 wire have a black Drive Stop™.

- Pounds per box is approximate and can vary + or – 10% depending on variances in wire weights and tolerances of staples during manufacture.

★ Made in USA
 ⚡ Harsh Environment Product

A	B	C	Part #	Pcs/Box	Boxes/ Carton	Approximate lbs/Box
Overall Length	Inside Spread	Wire Diameter				
For #4 AWG Ground Wire						
2	5/8	.162	DG2063Q-#4 ★ ⚡	100	5	3.20
For #6 AWG Ground Wire						
2	5/8	.162	DG2063Q-#6 ★ ⚡	100	5	3.30

SERRATED ELECTRO-ZINC DIAMOND POINT STAPLES • BOX PACK

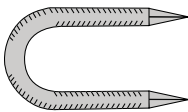

- Pounds per box is approximate and can vary + or – 10% depending on variances in wire weights and tolerances of staples during manufacture.

A	B	C	Part #	Pcs/Box	Boxes/ Carton	Approximate lbs/Box
Overall Length	Inside Spread	Wire Diameter				
1 3/4	3/8	.148	DZ1738K(S)* ★	100	10	1.57
2	5/8	.187	DZ2063S(S)* ★	100	10	2.81

*MOQ (Minimum Order Quantity)

★ Made in USA

ELECTRO-ZINC FLAT TOP DIAMOND POINT STAPLE

A	B	C	Part #	Pcs/Box	Boxes/ Carton	Approximate lbs/Box
Overall Length	Inside Spread	Wire Diameter				
2	5/8	.162	DZ2063Q(F) ★	100	10	2.24
2	5/8	.162	DZ2063Q(F)-XZ ★	100	10	2.00

★ Made in USA

SERRATED GALVANIZED DIAMOND POINT STAPLES • BOX PACK

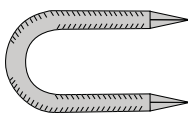

- Pounds per box is approximate and can vary + or – 10% depending on variances in wire weights and tolerances of staples during manufacture.

A	B	C	Part #	Pcs/Box	Boxes/ Carton	Approximate lbs/Box
Overall Length	Inside Spread	Wire Diameter				
1 3/4	3/8	.148	DG1738K(S) ★ ⚡	100	10	1.57

★ Made in USA

⚡ Harsh Environment Product

STAPLE MEASURING GUIDE

The following measurements correspond to those found at the top of the following pages:

Dimension A (Overall Length) – Measurement taken from top of staple to its tip.

Dimension B (Inside Spread) – Measurement taken towards top of staple as indicated.

Dimension C (Wire Diameter) – Diameter of wire used in forming the staple. (See Wire Guide Reference on page 268.)

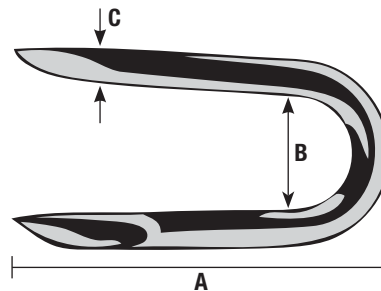

Cut (Slash) Point Staple

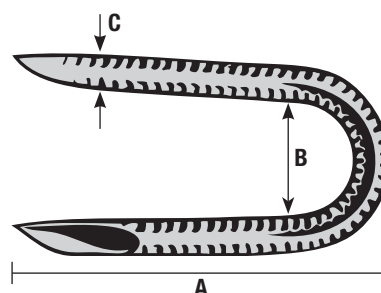

Serrated Cut (Slash) Point Staple

PRE-GALVANIZED CUT POINT STAPLES • BULK PACK • 50LB KEG



- Pounds per box is approximate and can vary + or – 10% depending on variances in wire weights and tolerances of staples during manufacture.

REDMORE

A	B	C	Part #	Approximate Pcs/50 lb Keg	Approximate Pcs/lb
Overall Length	Inside Spread	Wire Diameter			
1¼	¼	.148	CP1225K ★	4675	94.00
1½	¼	.148	CP1525K ★	3750	75.00
1½	⅝ ₁₆	.148	CP1531K ★	3750	75.00
1½	½	.148	CP1550K ★	3750	75.00
1¾	¼	.148	CP1725K ★	3200	64.00
2	¼	.148	CP2025K* ★	2907	58.14
2¾	¾	.187	CP2775S* ★	1285	25.70

*MOQ (Minimum Order Quantity)

★ Made in USA

For 50lb keg packaging, contact customer service for quantities and availability.

GALVANIZED CUT POINT STAPLES • BULK PACK • 50LB KEG



- Pounds per box is approximate and can vary + or – 10% depending on variances in wire weights and tolerances of staples during manufacture.

A	B	C	Part #	Approximate Pcs/50 lb Keg	Approximate Pcs/lb
Overall Length	Inside Spread	Wire Diameter			
1½	¼	.148	CG1525K ★ ♥	3500	70.00
1½	⅜	.148	CG1538K* ★ ♥	3600	72.00
1¾	⅜	.148	CG1738K* ★ ♥	3125	62.50
2	½	.162	CG2050Q ★ ♥	2235	44.70

*MOQ (Minimum Order Quantity)

★ Made in USA

♥ Harsh Environment Product

COPPERCLAD CUT POINT STAPLES • BULK PACK • 50LB KEG



- Due to volatility of copper market, please contact customer service for pricing.
- Pounds per box is approximate and can vary + or – 10% depending on variances in wire weights and tolerances of staples during manufacture.

A	B	C	Part #	Approximate Pcs/50 lb Keg	Approximate Pcs/lb
Overall Length	Inside Spread	Wire Diameter			
1½	⅜	.162	CC1538Q ★	3075	61.50
1¾	⅜	.144	CC1738I ★	3275	66.00
2	¼	.162	CC2025Q ★	2450	49.00
2	½	.162	CC2050Q ★	2275	46.00

★ Made in USA

COMMON NAILS SIZE GUIDE

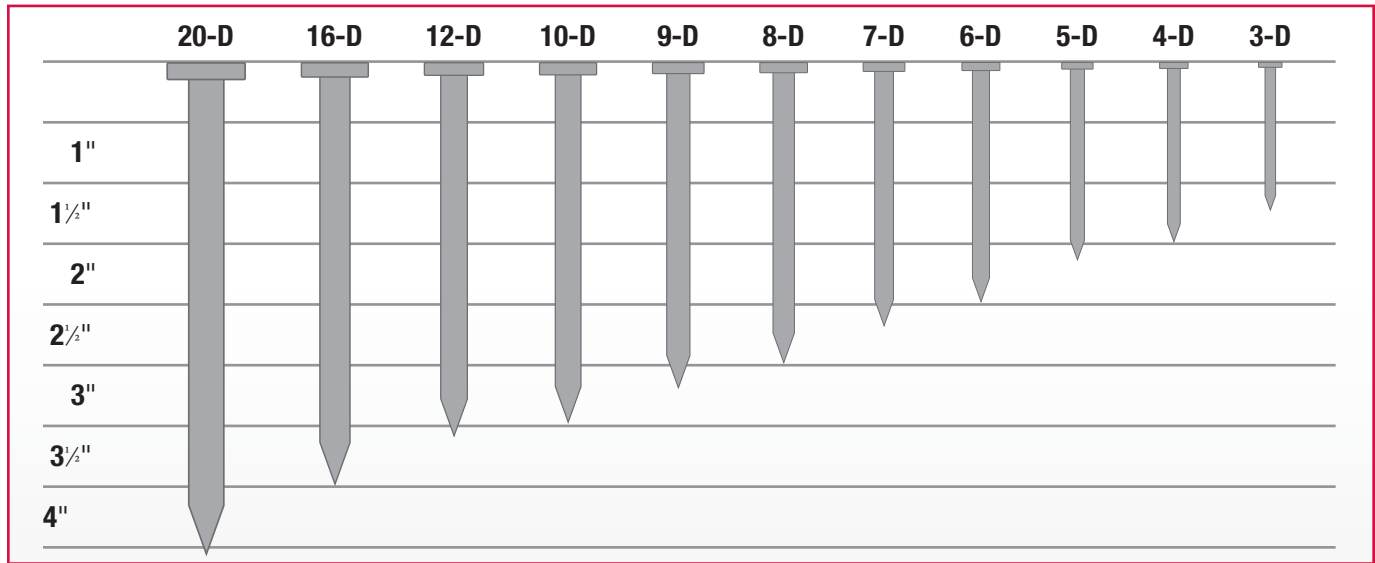

Note: See Wire Guide Reference on page 268.

COPPERCLAD COMMON NAILS • BULK PACK • 50 LB KEG



- Pounds per box is approximate and can vary + or – 10% depending on variances in wire weights and tolerances of staples during manufacture.
- Due to volatility of copper market, please contact customer service for pricing.

Size	Length (Inches)	Diameter (Inches)	Part #	Approximate Pcs/50 lb Keg	Approximate Pcs/lb
6-D	2	.114	NC06* ★	7500	150
10-D	3	.144	NC10 ★	3450	69
16-D	3½	.162	NC16 ★	2350	47

*MOQ (Minimum Order Quantity)

★ Made in USA

GALVANIZED MARKING NAILS























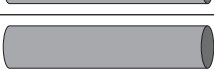





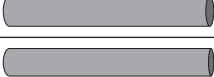







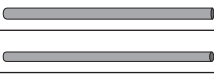





- All marking nails are 2½ x 6 gauge with ½" heads and weigh approximately 2.3 lbs per 100 pieces + or – 10% depending on variances in wire weights and tolerances of nails during manufacture.

Data & Blank Dating			
Description	Part #	Pcs/Box	lbs/Box
2016 Dating	ND216 ★ ♡	100	2.2
2017 Dating	ND217 ★ ♡	100	2.2
2018 Dating	ND218 ★ ♡	100	2.2
Blank Dating	ND1900 ★ ♡	100	2.2

Data Dating		
Description	Part #	Approximate Pcs/50 lb Keg
2017 Dating	ND317 ★ ♡	2350
2018 Dating	ND318 ★ ♡	2350

★ Made in USA

♡ Harsh Environment Product

American Steel and Wire Gauge					
Actual Size of Wire	Gauge	Gauge	Diameter	lbs/ft	ft/lb
		000	.3625	.3505	2.853
		00	.3310	.2922	3.422
		0	.3065	.2506	3.991
		1	.2830	.2136	4.681
		2	.2625	.1838	5.441
		3	.2437	.1584	6.313
		4	.2253	.1354	7.386
		5	.2070	.1143	8.750
		6	.1920	.09832	10.17
		7	.1770	.08356	11.97
		8	.1620	.07000	14.29
		9	.1483	.05866	17.05
		10	.1350	.04861	20.57
		11	.1205	.03873	25.82
		12	.1055	.02969	33.69
		13	.0915	.02233	44.78
		14	.0800	.01707	58.58
		15	.0720	.01383	72.32
		16	.0625	.01042	95.98
		17	.0540	.007778	128.6
		18	.0475	.006018	166.2

Fraction	Decimal
1/64	.015625
1/32	.03125
3/64	.046875
1/16	.0625
5/64	.078125
3/32	.09375
7/64	.109375
1/8	.125
9/64	.1450625
5/32	.15625
11/64	.171875
3/16	.1875
13/64	.203125
7/32	.21875
15/64	.234375
1/4	.25
17/64	.265625
9/32	.28125
19/64	.296875
5/16	.3125
21/64	.328125
11/32	.34375
23/64	.359375
3/8	.375
25/64	.390625
13/32	.40625
27/64	.421875
7/16	.4375
29/64	.453125
15/32	.46875
31/64	.484375
1/2	.5
33/64	.515625
17/32	.53125
35/64	.546875
9/16	.5625
37/64	.578125
19/32	.59375
39/64	.609375
5/8	.625
41/64	.640625
21/32	.65625
43/64	.671875
11/16	.6875
45/64	.703125
23/32	.71875
47/64	.734375
3/4	.75
49/64	.765625
25/32	.78125
31/64	.796875
13/16	.8125
53/64	.828125
27/32	.84375
55/64	.859375
7/8	.875
57/64	.890625
29/32	.90625
59/64	.921875
15/16	.9375
61/64	.953125
31/32	.96875
63/64	.984375
1	1

The Wire Gauge Chart shown above is used as a standard by practically all the steel manufacturers in the United States, on recommendation of the Bureau of Standards at Washington, D.C.

Gauges such as Brown & Sharpe and screw gauges do not apply.



MACHINE SCREWS
ROUND SCREWS



SHEET METAL SCREWS



HEX SCREWS



DRYWALL SCREWS
WOOD SCREWS



BOLT
NUT



WASHERS



ANCHOR



FASTENER
LAG BOLT

PRODUCT DISPLAYS





Gravity Feed Jar Rack Display

- Available in three and four foot displays to maximize showroom space.
- Heavy duty display with locking casters.
- Color coded headers.
- Stair stepped shelving to maximize product visibility.
- Wire dividers for product organization and space allocation.
- Magnetic shelf labels featuring product color code and UPC information.

Gravity Feed Jar Rack

Description	Part #	Qty
36" W x 75" H	94353	1
48" W x 75" H	94352	1

Gravity Feed Jar Rack Headers

Description	Part #	Qty
36" Header	00067	1
48" Header	00068	1





Gondola Display

Increase sales with our gravity feed gondola display and custom merchandising Plan-O-Gram program with qualifying order. Together we will design a custom merchandising Plan-O-Gram program to target your specific market needs. Contact a Minerallac Company representative for details

- Available in three and four foot displays.
- Low maintenance gravity feed display to promote high impulse buying.
- Clean and organized display presentation.
- Suitable for a wall installation or freestanding set-up.

Gondola Display

Description	Part #	Qty
36" W x 54" H, Gondola	94354	1
36" W x 12" D, Shelf	94312	1
48" W x 54" H, Heavy Duty	94454	1
48" W X 66" H, Heavy Duty	94466	1
48" W x 10" D, Shelf	94410	1
48" W x 12" D, Shelf	94412	1
Caster Base for 36" Gondola	94356	1
Caster Base for 48" Gondola	94456	1

Peg Hooks

Description	Part #	Qty
1/8" Gauge x 6" Long	94006	1
1/4" Gauge x 8" Long	94008	1

Gondola Headers

Description	Part #	Qty
36" Header w/ Bracket	00065	1
48" Header w/ Bracket	00069	1



Accusharp® Knife Sharpener Display

Part #00037

- Attractive signage attached to a demo unit.
- No charge with qualifying order of 12 sharpeners.



Accusharp® Knife Sharpener Floor Display

Part #00046

- Free standing unit.
- Attention grabbing signage.
- No charge with qualifying order of 36 sharpeners.



Krylon®/Sprayon® Display

Part #00047

- Gravity fed, 5 shelf freestanding unit.
- Attention grabbing header sign.
- Free with qualifying order of \$300 or more.



Plastic Boxes

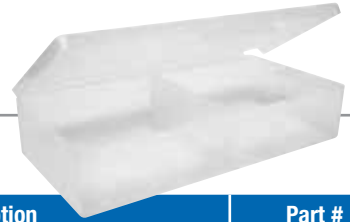

Description	Part #
Single Compartment Plastic Box	93315
Double Compartment Plastic Box	93320

Cully™ Screwdriver Counter Display

Part #37125

- Maximize your POP sales with this great looking counter display.
- See page 136-137 for a full list of parts.



Krylon®/Sprayon® Counter Display

Part #37700

- Holds 18 cans of paint, chemicals or caulk.
- Attention grabbing header sign.
- Free with qualifying order of 72 cans/tubes.



Displays

Masonry Drill Bit Wall Mount Display

Part #59761

- 10 peg wall mounting rack with attractive signage.
- No charge with qualifying order. See page 148 for details.



Glove Wall Mount Display • Peg Hook

Part #67598

- 10 peg wall mounting display with bold header sign.
- Place an opening order of \$300 to receive this glove rack and header at no additional charge.
- See pages 174-176 for glove selection.



Morse® Reciprocating Saw Blade Wall Mount Display

Part #95328

- No charge with qualifying order over \$300 of any reciprocating blade.



Counter Glove Display

Part #67585

- Free with first time order of 24 pairs of work gloves.
- See pages 174-176 for glove selection.



CrossFire® Display

Part #19119

- No charge counter display with qualifying order.



Morse® Hole Saw Wall Mount Display

Part #86553

- No charge with qualifying order.



Shovel Hooks

Part #00042

- Wall mounted peg hooks are designed to hold shovels in smaller spaces.
- Free with qualifying order of 12.

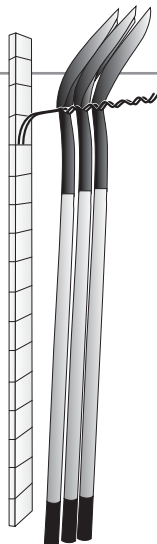

Numerical Index

0

0 193
 OB 193
 OS 194
 OSB 194
 00037 272
 00042 273
 00046 272
 00047 272
 00065 271
 00067 270
 00068 270
 00069 271
 09382 149

1

1 193
 1B 193
 1S 194
 1SB 194
 10 193
 10B 193
 102 196
 103 196
 105 196
 1055C 198
 10030 122
 10406 14
 10408 14
 10410 14
 10412 14
 10604 14
 10606 14
 10606TP 46
 10608 14
 10608TP 46
 10610 14
 10610TP 46
 10612 14
 10612J 14
 10612TP 46
 10616 14
 10616J 14
 10616TP 46
 10620 14
 10620TP 46
 10624 14
 10624J 14
 10624TP 46
 10628 14
 10632 14
 10632TP 46
 10707 24
 10707-6 24
 10707J 24
 10708 24
 10708-6 24
 10708J 24
 10806 14
 10806J 14
 10806TP 46
 10808 14
 10808J 14
 10808TP 46
 10808XP 47
 10810 14
 10812 14
 10812-6 14
 10812J 14
 10812SP 47
 10812TP 46
 10812XP 47
 10816 14
 10816-6 14
 10816J 14
 10816SP 47
 10816TP 46
 10816XP 47
 10820 14

10820-6 14
 10820J 14
 10820TP 46
 10820XP 47
 10824 14
 10824-6 14
 10824J 14
 10824TP 46
 10828 14
 10832 14
 10832J 14
 10832TP 46
 10840 14
 10840J 14
 10848 14
 110 196
 11008 14
 11008-6 14
 11008J 14
 11008SP 47
 11008TP 46
 11008XP 47
 11010 14
 11010J 14
 11010TP 46
 11012 14
 11012-6 14
 11012J 14
 11012SP 47
 11012TP 46
 11012XP 47
 11016 14
 11016-6 14
 11016J 14
 11016SP 47
 11016TP 46
 11016XP 47
 11020 14
 11020-6 14
 11020J 14
 11020TP 46
 11020XP 47
 11024 14
 11024-6 14
 11024J 14
 11024TP 46
 11024XP 47
 11028 14
 11032 14
 11032-6 14
 11032J 14
 11032TP 46
 11040 14
 11040J 14
 11048 14
 11048J 14
 1105 201
 11208 14
 11208J 14
 11208TP 46
 11210 14
 11212 14
 11212J 14
 11212TP 46
 11216 14
 11216J 14
 11216TP 46
 11220 14
 11220J 14
 11220TP 46
 11224 14
 11224J 14
 11224TP 46
 11228 14
 11232 14
 11232J 14
 11232TP 46
 11240 14
 11240J 14
 11248 14
 11248J 14
 11408 15
 11408TP 46
 11410 15
 11412 15
 11412TP 46
 11416 15
 11416TP 46
 11420 15
 11420TP 46
 11424 15
 11428 15
 11432 15
 11440 15
 11448 15
 115 196
 1155C 198
 120 196
 121 196, 202
 12406 39
 12408 39
 12412 39
 12412J 39
 12416 39
 12416J 39
 125 196, 202
 12512 39
 12606 21
 12606TP 46
 12608 21, 39
 12608J 21, 39
 12608TP 46
 12610 21, 39
 12610TP 46
 12612 21, 39
 12612J 39
 12612J 21
 12616 21, 39
 12616J 21, 39
 12616TP 46
 12620 39
 12620TP 46
 12621 21
 12624 39
 12624TP 46
 12625 21
 12628 39
 12632 39
 12632TP 46
 12633 21
 12806TP 46
 12808 21, 39
 12808J 21, 39
 12808TP 46
 12810 21, 39
 12810J 21, 39
 12812 21, 39
 12812J 21, 39
 12812TP 46
 12812XP 47
 12816 21, 39
 12816J 21, 39
 12816TP 46
 12816XP 47
 12820 39
 12820TP 46
 12820XP 47
 12821 21
 12821J 21
 12824 39
 12824J 39
 12824TP 46
 12825 21
 12828 39
 12832 39
 12832J 39
 12832TP 46
 12833 21
 12840 39
 12848 39
 12856 39
 12864 39
 130 196, 202
 13008 21, 39
 13008TP 46
 13010 21
 13010TP 46
 13012 21, 39
 13012J 21, 39
 13012TP 46
 13012XP 47
 13016 21, 39
 13016J 21, 39
 13016TP 46
 13016XP 47
 13020 39
 13020J 39
 13020TP 46
 13020XP 47
 13021 21
 13024 39
 13024J 39
 13024TP 46
 13025 21
 13028 39
 13032 39
 13032J 39
 13032TP 46
 13033 21
 13036 39
 13040 39
 13048 39
 13056 40
 13064 40
 13208TP 46
 13212 21, 40
 13212TP 46
 13216 21, 40
 13216TP 46
 13220 40
 13220TP 46
 13221 21
 13224 40
 13224TP 46
 13225 21
 13232 40
 13232TP 46
 13240 40
 13248 40
 13256 40
 13264 40
 13408TP 46
 13412 40
 13412TP 46
 13416 40
 13416TP 46
 13420 40
 13420TP 46
 13424 40
 13432 40
 13440 40
 13448 40
 13456 40
 13464 40
 135 196
 13616 42
 13624 42
 13632 42
 13716 41
 13716lb 41
 13726 41
 13726lb 41
 13736 41
 13736lb 41
 13748 41
 13748lb 41
 13812 42
 13812J 42
 13814 41
 13815 41
 13816 42
 13820 42
 13820J 42
 13822 41
 13824 42
 13824J 42
 13826 41
 13828 42
 13830 41
 13832 42
 13832J 42
 13834 41
 13836 42
 13838 41
 13840 42
 13840J 42
 13842 41
 13848 42
 13850 41
 14WNW 221
 140 196, 202
 14016 42
 14020 42
 14022 41
 14024 42
 14026 41
 14028 42
 14030 41
 14032 42
 14036 42
 14038 41
 14040 42
 14048 42
 14300 126
 14305 126
 145 196, 202
 14608TP 46
 14612TP 46
 14616TP 46
 14620TP 46
 14624TP 46
 14808 20
 14808J 20
 14808TP 46
 14809 23
 14809-6 23
 14809J 23
 14810 20
 14810J 20
 14811 23
 14811-6 23
 14811J 23
 14812 20
 14812-6 20
 14812J 20
 14812TP 46
 14813 23
 14813-6 23
 14813J 23
 14816 20
 14816-6 20
 14816J 20
 14816TP 46
 14817 23
 14817-6 23
 14817J 23
 14820 20
 14820-6 20
 14820J 20
 14820TP 46
 14821 23
 14821-6 23
 14821J 23
 14824 20
 14824J 20
 14824TP 46
 14828 20
 14832 20
 14832J 20
 14840 20
 14849 20
 150 196, 202
 15008 20
 15008-6 20
 15008J 20
 15008TP 46

Numerical Index

15010TP	46	19013J	17	19850	170	20720TP	48	22508TP	48
15012	20	19017	17	19852	170	20724	34	22508XP	49
15012-6	20	19017-6	17	19860	170	20724J	34	22512	31
15012J	20	19017J	17	19862	170	20724SP	49	22512J	31
15012TP	46	19021	17	19870	170	20724TP	48	22512SP	49
15016	20	19021-6	17	19872	170	20732	34	22512TP	48
15016-6	20	19021J	17	19874	170	20732J	34	22512XP	49
15016J	20	19025	17	19880	169	20732TP	48	22516	31
15016TP	46	19025-6	17			20740	34	22516J	31
15020	20	19025J	17			20748	34	22516SP	49
15020-6	20	19033	17			20808	34	22516TP	49
15020J	20	19033-6	17			20808SP	49	22516XP	48
15020TP	46	19033J	17			20812	34	22520	31
15024	20	19041	17			20812SP	49	22520J	31
15024-6	20	19041J	17			20816	34	22520TP	48
15024J	20	19049	17			20816SP	49	22524	31
15024TP	46	19049J	17			20820	34	22524J	31
15032	20	19100	167			20824SP	49	22524TP	48
15032-6	20	19101	167			21008	34	22532	31
15032J	20	19102	167			21008SP	49	22532J	31
15049	20	19103	167			21012	34	22532TP	48
15212	20	19105	167			21012SP	49	22604XP	49
15216	20	19106	167			21016	34	22606	31
155	196, 202	19110	168			21016SP	49	22606SP	49
160	196, 202	19115	168			21020	34	22606TP	48
165	196	19119	273			21020SP	49	22606XP	49
170	196	19120	168			21024	34	22608	31
18020-6	45	19125	167			21024SP	49	22608SP	49
180201lb	45	19126	167			21032	34	22608TP	48
180205lb	45	19127	167			21032SP	49	22608XP	49
18022-6	45	19130	168			21040	34	22610	31
180221lb	45	19131	168			21048	34	22612	31
180225lb	45	19132	168			212	203	22612J	31
18026-6	45	19135	167			2203	203	22612SP	49
180261lb	45	19136	167			221	203	22612TP	48
180265lb	45	19137	167			22200	179	22612XP	49
18132-6	45	19209	17			22202	179	22616	31
181321lb	45	19209J	17			22204	179	22616J	31
181325lb	45	19213	17			22206	179	22616SP	49
18140-6	45	19213J	17			22208	179	22616TP	48
181405lb	45	19217	17			22210	179	22616XP	49
181401lb	45	19217J	17			22212	179	22620	31
18148-6	45	19221	17			22214	179	22620J	31
181481lb	45	19221J	17			22216	179	22620TP	48
181485lb	45	19225	17			22218	179	22624	31
18264-6	45	19225J	17			22220	179	22624J	31
182641lb	45	19233	17			22222	179	22624SP	49
182645lb	45	19233J	17			22224	179	22624TP	48
182801lb	45	19241	17			22226	179	22628	31
182805lb	45	19241J	17			22228	179	22632	31
182961lb	45	19249	17			22230	179	22632J	31
182965lb	45	19249J	17			22240	179	22632TP	48
18609	17	19413	17			22244	179	22704SP	49
18609J	17	19413J	17			22254	179	22706SP	49
18613	17	19417	17			22256	179	22708	31
18613J	17	19417J	17			22258	179	22708SP	49
18617	17	19421	17			22260	179	22708TP	48
18617J	17	19421J	17			22262	179	22710TP	48
18621	17	19425	17			22264	179	22712	31
18621J	17	19425J	17			22280	179	22712SP	49
18625	17	19433	17			22282	179	22712TP	48
18625J	17	19433J	17			22284	179	22716	31
18809	17	19602	171			22286	179	22716J	31
18809J	17	19604	171			22290	178	22716SP	49
18813	17	19608	171			22292	178	22716TP	48
18813-6	17	19610	171			22294	178	22720	31
18813J	17	19612	171			22296	178	22720TP	48
18817	17	19804	169			22298	178	22724	31
18817-6	17	19805	169			223	203	22724J	31
18817J	17	19806	169			22329	172	22724SP	49
18821	17	19807	169			22337	172	22724TP	48
18821-6	17	19808	169			225	200, 203	22732	31
18821J	17	19809	169			22504	31	22732TP	48
18825	17	19810	169			22504SP	49	22740	31
18825J	17	19811	169			22504XP	49	22748	31
18833	17	19812	169			22506	31	22748J	31
18833J	17	19814	169			22506SP	49	228	200, 203
19009	17	19831	169			22506TP	48	22804SP	49
19009-6	17	19832	169			22506XP	49	22806SP	49
19009J	17	19840	169			22508	31	22808	31
19013	17	19843	169			22508J	31	22808SP	49
19013-6	17	19844	169			22508SP	49	22808TP	48

2

Numerical Index

40755.....	64	43810.....	61	50532.....	35	52016.....	37	52616J.....	29
40755J.....	64	43815.....	61	50540.....	35	52016-6.....	37	52620.....	29
40760.....	60	45432.....	146	50548.....	35	52016J.....	37	52620J.....	29
40760J.....	60	478C.....	222	50708.....	35	52020.....	37	52624.....	29
40762.....	60			50712.....	35	52020J.....	37	52624J.....	29
40762J.....	60			50716.....	35	52024.....	37	52632.....	29
40905.....	61			50716J.....	35	52024-6.....	37	52632J.....	29
40910.....	61			50720.....	35	52024J.....	37	52648.....	29
40915.....	61			50724.....	35	52032.....	37	52648J.....	29
40925.....	61			50732.....	35	52032-6.....	37	52716SS.....	33
40925SS.....	61			50740.....	35	52032J.....	37	52716SSJ.....	33
40925SSJ.....	61			50748.....	35	52048.....	37	52809.....	29
410C.....	222			50908.....	35	52064.....	37	52809-6.....	29
410C100.....	222			50912.....	35	52133.....	37	52809J.....	29
41110.....	56			50916.....	35	52149.....	37	52813.....	29
41115.....	56			50916J.....	35	52165.....	37	52813J.....	29
41120.....	56			50920.....	35	52206.....	29	52817.....	29
41122.....	56			50920J.....	35	52206J.....	29	52817J.....	29
41125.....	56			50924.....	35	52208.....	29	52821.....	29
41125J.....	56			50924J.....	35	52208-6.....	29	52821J.....	29
41130.....	56			50932.....	35	52208J.....	29	52825.....	29
41130J.....	56			50940.....	35	52212.....	29	52825J.....	29
41135.....	56			50948.....	35	52212J.....	29	52833.....	29
41135J.....	56			50948J.....	35	52216.....	29	52833J.....	29
41140.....	56			51103.....	38	52216J.....	29	52906SS.....	33
41140J.....	56			51103J.....	38	52220.....	29	52906SSJ.....	33
41145.....	56			51104.....	38	52220J.....	29	52908SS.....	33
41310.....	59			51104J.....	38	52224.....	29	52908SSJ.....	33
41315.....	59			51105.....	38	52224J.....	29	52912SS.....	33
41320.....	59			51105J.....	38	52232.....	29	52912SSJ.....	33
41325.....	59			51107.....	38	52232J.....	29	52916SS.....	33
41331.....	59			51107J.....	38	52240.....	29	52916SSJ.....	33
41336.....	59			51108.....	38	52240J.....	29	52920SS.....	33
41341.....	59			51108J.....	38	52248.....	29	52920SSJ.....	33
41415.....	59			51109.....	38	52248J.....	29	52924SS.....	33
41420.....	59			51109J.....	38	52249.....	37	52924SSJ.....	33
41425.....	59			51110.....	38	52265.....	37	53006.....	30
41430.....	59			51110J.....	38	52306SS.....	33	53006-6.....	30
41435.....	59			51111.....	38	52306SSJ.....	33	53006J.....	30
42310.....	63			51112.....	38	52308SS.....	33	53008.....	30
42315.....	63			51112J.....	38	52308SSJ.....	33	53008-6.....	30
42325.....	63			51113.....	38	52312SS.....	33	53008J.....	30
42330.....	63			51113J.....	38	52312SSJ.....	33	53012.....	30
42335.....	63			51114.....	38	52316SS.....	33	53012-6.....	30
42340.....	63			51115.....	38	52316SSJ.....	33	53012J.....	30
42340J.....	63			51116.....	38	52356.....	29	53016.....	30
42345.....	63			51116J.....	38	52364.....	29	53016-6.....	30
42350.....	63			51117.....	38	52364J.....	29	53016J.....	30
42505.....	65			51117J.....	38	52406.....	29	53020.....	30
42510.....	65			51118.....	38	52406-6.....	29	53020J.....	30
42515.....	65			51208.....	50	52406J.....	29	53024.....	30
42515J.....	65			51212.....	50	52408.....	29	53024J.....	30
42517.....	65			51216.....	50	52408-6.....	29	53032.....	30
42525.....	65			51412.....	50	52408J.....	29	53032J.....	30
42525J.....	65			51416.....	50	52412.....	29	53040.....	30
42530.....	65			51420.....	50	52412-6.....	29	53040J.....	30
42535.....	65			51424.....	50	52412J.....	29	53048.....	30
42540.....	65			51432.....	50	52416.....	29	53048J.....	30
42540J.....	65			51512.....	50	52416-6.....	29	53064.....	30
42545.....	65			51516.....	50	52416J.....	29	53064J.....	30
42550.....	65			51520.....	50	52420.....	29	53212.....	30
43105.....	56			51524.....	50	52420-6.....	29	53212J.....	30
43110.....	56			51532.....	50	52420J.....	29	53216.....	30
43115.....	56			51706.....	50	52424.....	29	53216J.....	30
43120.....	56			51708.....	50	52424-6.....	29	53220.....	30
43122.....	56			51712.....	50	52424J.....	29	53220J.....	30
43125.....	56			51716.....	50	52432.....	29	53224.....	30
43125J.....	56			51720.....	50	52432-6.....	29	53224J.....	30
43130.....	56			51724.....	50	52432J.....	29	53232.....	30
43135.....	56			51806.....	50	52440.....	29	53232J.....	30
43140.....	56			51808.....	50	52440J.....	29	53248.....	30
43305.....	63			51812.....	50	52448.....	29	53248J.....	30
43310.....	63			51816.....	50	52448J.....	29	53264.....	30
43315.....	63			51820.....	50	524516SS.....	33	53264J.....	30
43320.....	63			51820J.....	50	52516SSJ.....	33	53608.....	38
43325.....	63			51824.....	50	52606.....	29	53608J.....	38
43330.....	63			51824J.....	50	52606J.....	29	53612.....	38
43335.....	63			51832.....	50	52608.....	29	53616.....	38
43340.....	63			52008.....	37	52608J.....	29	53708.....	38
43345.....	63			52008J.....	37	52612.....	29	53712.....	38
43350.....	63			52012.....	37	52612J.....	29	53716.....	38
43805.....	61			52012J.....	37	52616.....	29	53716J.....	38

5

Numerical Index

53808.....	38	55048.....	70	55420J.....	70	55864.....	70	58164.....	85
53812.....	38	55048J.....	70	55421.....	71	55864J.....	70	58165.....	85
54108.....	73	55049.....	71	55421J.....	71	56108.....	50	58165J.....	85
54110.....	73	55049J.....	71	55421USJ.....	71	56112.....	50	58231.....	86
54112.....	73	55049USJ.....	71	55422.....	69	56116.....	50	58332.....	85
54116.....	73	55050.....	69	55422J.....	69	56312.....	50	58333.....	85
54120.....	73	55056.....	70	55424.....	70	56316.....	50	58333J.....	85
54124.....	73	55064.....	70	55424J.....	70	56320.....	50	58348.....	85
54132.....	73	55112.....	68	55425.....	71	56324.....	50	58348J.....	85
54208.....	73	55116.....	68	55425J.....	71	57016.....	67	58349.....	85
54212.....	73	55120.....	68	55425USJ.....	71	57016J.....	67	58349J.....	85
54216.....	73	55124.....	68	55432.....	70	57020.....	67	58364.....	85
54216J.....	73	55132.....	68	55432J.....	70	57020J.....	67	58364J.....	85
54220.....	73	55140.....	68	55433.....	71	57024.....	67	58365.....	85
54224.....	73	55148.....	68	55433J.....	71	57024J.....	67	58365J.....	85
54232.....	73	55156.....	68	55433USJ.....	71	57032.....	67	58396.....	86
54408.....	73	55164.....	68	55434.....	69	57032J.....	67	58396J.....	86
54412.....	73	55208.....	70	55440.....	70	57040.....	67	58431.....	86
54416.....	73	55209.....	71	55440J.....	70	57040J.....	67	58431J.....	86
54420.....	73	55209J.....	71	55441.....	71	57048.....	67	58496.....	86
54424.....	73	55209USJ.....	71	55441J.....	71	57048J.....	67	58496J.....	86
54424J.....	73	55212.....	70	55441USJ.....	71	57056.....	67	58531.....	86
54432.....	73	55212J.....	70	55442.....	69	57056J.....	67	58548.....	85
54440.....	73	55213.....	71	55448.....	70	57064.....	67	58548J.....	85
54448.....	73	55213J.....	71	55448J.....	70	57064J.....	67	58549.....	85
54456.....	73	55213USJ.....	71	55449.....	71	57216.....	67	58549J.....	85
54464.....	73	55216.....	71-72	55449J.....	71	57220.....	67	58564.....	85
54812.....	73	55216J.....	70	55449USJ.....	71	57224.....	67	58564J.....	85
54816.....	73	55217.....	71	55450.....	69	57224J.....	67	58565.....	85
54820.....	73	55217J.....	71	55456.....	70	57232.....	67	58565J.....	85
54824.....	73	55217USJ.....	71	55456J.....	70	57232J.....	67	58631.....	86
54824J.....	73	55220.....	70	55464.....	70	57240.....	67	58631J.....	86
54828.....	73	55220J.....	70	55464J.....	70	57240J.....	67	58647.....	86
54832.....	73	55221.....	71	55512.....	68	57248.....	67	58648.....	86
54832J.....	73	55221J.....	71	55516.....	68	57248J.....	67	58648J.....	86
54840.....	73	55221USJ.....	71	55520.....	68	57256.....	67	58664.....	86
54840J.....	73	55224.....	70	55524.....	68	57264.....	67	58664J.....	86
54848.....	73	55224J.....	70	55532.....	68	57264J.....	67	58680.....	86
54848J.....	73	55225.....	71	55540.....	68	57416.....	67	58696.....	86
54856.....	73	55225J.....	71	55540J.....	68	57416J.....	67	58696J.....	86
54864.....	73	55225USJ.....	71	55548.....	68	57420.....	67	58732.....	84
55008.....	72	55227.....	69	55556.....	68	57420J.....	67	58742.....	84
55008J.....	72	55232.....	70	55564.....	68	57424.....	67	58743.....	84
55009.....	73	55233.....	71	55812.....	70	57424J.....	67	58744.....	84
55009J.....	73	55233J.....	71	55812J.....	70	57432.....	67	58816.....	84
55009USJ.....	73	55233USJ.....	71	55813.....	71	57432J.....	67	58817.....	84
55012.....	70	55234.....	69	55813J.....	71	57440.....	67	58818.....	84
55012J.....	70	55240.....	70	55813USJ.....	71	57440J.....	67	58900.....	84
55013.....	71	55240J.....	70	55816.....	70	57448.....	67	59011.....	78
55013J.....	71	55241.....	71	55816J.....	70	57448J.....	67	59011J.....	78
55013USJ.....	71	55241J.....	71	55817.....	71	57456.....	67	59012.....	78
55016.....	70	55241USJ.....	71	55817J.....	71	57456J.....	67	59012J.....	78
55016J.....	70	55242.....	69	55817USJ.....	71	57464.....	67	59016.....	78
55017.....	71	55248.....	70	55820.....	68	57464J.....	67	59016-6.....	78
55017J.....	71	55248J.....	70	55820J.....	68	57472.....	67	59016J.....	78
55017USJ.....	71	55256.....	70	55821.....	71	57480.....	67	59020.....	78
55020.....	70	55264.....	70	55821J.....	71	57480J.....	67	59020-6.....	78
55020J.....	70	55312.....	68	55821USJ.....	71	57488.....	67	59020J.....	78
55021.....	71	55316.....	68	55824.....	70	57496.....	67	59024.....	78
55021J.....	71	55320.....	68	55824J.....	70	57824.....	67	59024J.....	78
55021USJ.....	71	55324.....	68	55825.....	71	57824J.....	67	59032.....	78
55022.....	69	55332.....	68	55825J.....	71	57832.....	67	59032J.....	78
55022J.....	69	55340.....	68	55825USJ.....	71	57840.....	67	59124.....	79
55024.....	70	55348.....	68	55826.....	69	57848.....	67	59132.....	79
55024J.....	70	55356.....	68	55832.....	70	57848J.....	67	59140.....	79
55025.....	71	55364.....	68	55832J.....	70	57856.....	67	59148.....	79
55025J.....	71	55408.....	70	55833.....	71	57864.....	67	59156.....	79
55025USJ.....	71	55408J.....	70	55833J.....	71	57864J.....	67	59164.....	79
55026.....	69	55409.....	71	55833USJ.....	71	57872.....	67	59248.....	52
55026J.....	69	55409J.....	71	55834.....	69	57880.....	67	59248J.....	52
55032.....	70	55409USJ.....	71	55840.....	70	57888.....	67	59250.....	52
55032J.....	70	55412.....	70	55840J.....	70	57896.....	67	59251.....	52
55033.....	71	55412J.....	70	55841.....	71	58031.....	86	59251J.....	52
55033J.....	71	55413.....	71	55841J.....	71	58031J.....	86	59264.....	52
55033USJ.....	71	55413J.....	71	55841USJ.....	71	58132.....	85	59280.....	52
55034.....	69	55413USJ.....	71	55842.....	69	58132J.....	85	59408.....	97
55035.....	69	55416.....	70	55848.....	70	58133.....	85	59408J.....	97
55040.....	70	55416J.....	70	55848J.....	70	58133J.....	85	59410.....	97
55040J.....	70	55417.....	71	55849.....	71	58148.....	85	59410J.....	97
55041.....	71	55417J.....	71	55850.....	69	58148J.....	85	59411.....	95
55041J.....	71	55417USJ.....	71	55856.....	70	58149.....	85	59412.....	97
55041USJ.....	71	55420.....	70	55856J.....	70	58149J.....	85	59412J.....	97

Numerical Index

59414.....	97	59808.....	107	60214J.....	83	61144J.....	102	61226.....	79
59414J.....	97	59810.....	107	60216.....	83	61145.....	102	61226J.....	79
59416.....	95	59904.....	147	60216J.....	83	61145J.....	102	61232.....	79
59416J.....	95	59906.....	147	60218.....	83	61147.....	102	61413.....	76
59417.....	95	59908.....	147	60218J.....	83	61147J.....	102	61413J.....	76
59418.....	95	59910.....	147	60236.....	83	61148.....	102	61422.....	76
59425.....	96	59912.....	147	60240.....	83	61148J.....	102	61617.....	76
59425J.....	96	59914.....	147	60242.....	83	61150.....	102	61617J.....	76
59431.....	99	59916.....	147	60244.....	83	61150J.....	102	61630.....	76
59431J.....	99	59918.....	147	60248.....	83	61152.....	102	61630J.....	76
59432.....	99	59920.....	147	60320.....	88	61152J.....	102	61640.....	76
59432J.....	99	59922.....	147	60320J.....	88	61154.....	102	61640J.....	76
59433.....	99	59980.....	147	60328.....	88	61154J.....	102	61822.....	76
59440.....	100	59984.....	147	60328J.....	88	61156.....	102	61822J.....	76
59450.....	96	59986.....	147	60336.....	88	61156J.....	102	61830.....	76
59504.....	96	59987.....	147	60336J.....	88	61157.....	102	61830J.....	76
59504J.....	96	59988.....	147	60344.....	88	61157J.....	102	61840.....	76
59505.....	96	59990.....	147	60344J.....	88	61160.....	103	62003.....	88
59505J.....	96	59991.....	147	60352.....	88	61160J.....	103	62006.....	88
59506.....	96	59992.....	147	60352J.....	88	61162.....	103	62028.....	81
59506J.....	96	59994.....	147	60360.....	88	61162J.....	103	62028J.....	81
59507.....	96	59996.....	147	60364.....	88	61164.....	103	62029.....	76
59507J.....	96	59998.....	147	60364J.....	88	61164J.....	103	62029J.....	76
59510.....	91			60402.....	83	61165.....	103	62036.....	81
59510J.....	91			60402J.....	83	61165J.....	103	62036J.....	81
59512.....	92			60404.....	83	61166.....	103	62037.....	81
59512J.....	92			60404J.....	83	61166J.....	103	62052.....	81
59515.....	93			60405.....	83	61167.....	103	62052J.....	81
59515J.....	93			60406.....	83	61167J.....	103	62053.....	81
59520.....	89			60406J.....	83	61168.....	103	62236.....	81
59520J.....	89			60408.....	83	61168J.....	103	62236J.....	81
59521.....	89			60410.....	83	61169.....	103	62237.....	81
59522.....	93			60440.....	83	61169J.....	103	62244.....	81
59522J.....	93			60444.....	83	61170.....	103	62244J.....	81
59604.....	108			60446.....	83	61170J.....	103	62245.....	81
59604J.....	108			60448.....	83	61172.....	103	62248.....	81
59605.....	108			60450.....	83	61172J.....	103	62248J.....	81
59606.....	108			60520.....	87	61174.....	103	62249.....	81
59606J.....	108			60528.....	87	61174J.....	103	62260.....	81
59608.....	108			60536.....	87	61175.....	103	62260J.....	81
59608J.....	108			60544.....	87	61175J.....	103	62280.....	81
59613.....	107			60552.....	87	61176.....	103	62280J.....	81
59613J.....	107			60560.....	87	61176J.....	103	62298.....	81
59614.....	106			60564.....	87	61177.....	103	62444.....	81
59614J.....	106			60602.....	82	61177J.....	103	62444J.....	81
59615.....	106			60602J.....	82	61179.....	103	62460.....	81
59615J.....	106			60604.....	82	61179J.....	103	62460J.....	81
59616.....	106			60606.....	82	61180.....	103	62468.....	81
59616J.....	106			60606J.....	82	61180J.....	103	62468J.....	81
59617.....	106			60608.....	82	61181.....	103	62488.....	81
59617J.....	106			60610.....	82	61181J.....	103	62498.....	81
59618.....	107			60610J.....	82	61182.....	102	62656.....	81
59620.....	107			60612.....	82	61182J.....	102	62672.....	81
59625.....	108			60612J.....	82	61183.....	102	62680.....	81
59625J.....	108			60614.....	82	61183J.....	102	62696.....	81
59626.....	108			60616.....	82	61185.....	104	62700.....	81
59626J.....	108			60618.....	82	61185J.....	104	62876.....	81
59643.....	106			60720.....	87	61186.....	104	62888.....	81
59645.....	106			60728.....	87	61186J.....	104	62897.....	81
59702.....	107			60736.....	87	61187.....	104	62898.....	81
59703.....	107			60736J.....	87	61187J.....	104	62900.....	81
59704.....	107			60744.....	87	61188.....	104	62910.....	81
59705.....	107			60752.....	87	61188J.....	104	63028.....	77
59706.....	107			60764.....	87	61190.....	104	63029.....	77
59708.....	107			60802.....	82	61194.....	105	63038.....	77
59710.....	107			60804.....	82	61194J.....	105	63039.....	77
59720.....	147			60806.....	82	61195.....	105	63132.....	77
59722.....	147			60808.....	82	61197.....	105	63144.....	77
59724.....	147			60810.....	82	61197J.....	105	63238.....	77
59726.....	147			60812.....	82	61198.....	105	63239.....	77
59728.....	147			60814.....	82	61198J.....	105	63256.....	77
59730.....	147			60816.....	82	61200.....	105	63257.....	77
59732.....	147			61102.....	87	61201.....	105	63276.....	77
59734.....	147			61103.....	87	61202.....	105	634R.....	217
59736.....	147			61105.....	87	61202J.....	105	634RW.....	217
59738.....	147			61107.....	87	61203.....	105	63444.....	77
59740.....	147			61108.....	87	61203J.....	105	63456.....	77
59761.....	273			61109.....	87	61204.....	105		
59804.....	107			61111.....	87	61204J.....	105		
59805.....	107			61113.....	87	61218.....	79		
59806.....	107			61144.....	102	61218J.....	79		

6

6.....	193
6B.....	193
6S.....	194
6SB.....	194
600.....	208
60002.....	90
60004.....	90
60004J.....	90
60006.....	90
60008.....	90
60010.....	208
60011.....	90
60012.....	90
60014.....	90
60016.....	90
60016J.....	90
60018.....	90
60018J.....	90
60020.....	90
60020J.....	90
60022.....	90
60024.....	90
60026.....	90
60026J.....	90
60028.....	90
60030.....	90
60112SS.....	36
60112SSJ.....	36
60116SS.....	36
60116SSJ.....	36
60120.....	88
60120J.....	88
60124SS.....	36
60124SSJ.....	36
60128.....	88
60128J.....	88
60132SS.....	36
60132SSJ.....	36
60136.....	88
60136J.....	88
60144.....	88
60144J.....	88
60152.....	88
60152J.....	88
60160.....	88
60164.....	88
602.....	208
602B.....	208
602BSS.....	208
60206.....	83
60206J.....	83
60212.....	83
60212J.....	83
60214.....	83

Numerical Index

63476.....	77	67421J.....	163	67662.....	175	69002.....	135	70525J.....	65
63496.....	77	67422J.....	163	67663.....	175	69003.....	135	70530.....	65
63664.....	77	67423J.....	163	67664.....	175	69004.....	135	70530J.....	65
63696.....	77	67424J.....	163	67665.....	175	69005.....	135	70535.....	65
63898.....	77	67450.....	180	67671.....	175	69006.....	135	70535J.....	65
64024.....	75	67452.....	180	67672.....	175	69007.....	135	70537.....	65
64032.....	75	67454.....	180	67680.....	160	69902.....	154	70540.....	65
64040.....	75	67456.....	180	67682.....	160	69904.....	154	70540J.....	65
64048.....	75	67458.....	180	67684.....	160	69950.....	108	70545.....	65
64132.....	75	67460.....	180	67686.....	160			70608.....	16
64132J.....	75	67462.....	180	67688.....	160			70612.....	16
64140.....	75	67464.....	180	67690.....	160			70616.....	16
64140J.....	75	67466.....	180	67692.....	160			70620.....	16
64148.....	75	67468.....	180	67694.....	160	7.....	193	70709.....	64
64148J.....	75	67470.....	180	67696.....	160	7B.....	193	70710.....	64
64164.....	75	67472.....	180	67699.....	161	7S.....	194	70720.....	64
64164J.....	75	67474.....	180	67700.....	161	7SB.....	194	70720J.....	64
64180f.....	75	67476.....	180	67710.....	161	700.....	208	70725.....	64
64180J.....	75	67478.....	180	67712.....	161	70000.....	110	70725J.....	64
64252f.....	75	67480.....	180	67714.....	161	70002.....	110	70730.....	64
64264.....	75	67484.....	180	67716.....	161	70010.....	208	70730J.....	64
64280.....	75	67486.....	180	67718.....	161	70012.....	110	70740.....	64
64364.....	75	67488.....	180	67720.....	161	70012J.....	110	70740.....	64
64364J.....	75	67490.....	180	67722.....	161	70016.....	110	70743.....	64
64380.....	75	67492.....	180	67724.....	161	70016J.....	110	70745.....	64
64380J.....	75	67494.....	180	67726.....	161	70020.....	110	70745J.....	64
64396.....	75	67496.....	180	67728.....	161	70020J.....	110	70808.....	16
64396J.....	75	67498.....	180	67730.....	161	70024.....	110	70810.....	16
64399.....	75	67499.....	180	67740.....	162	70024J.....	110	70812.....	16
64496.....	75	67509.....	175	67742.....	162	70032.....	110	70816.....	16
64499.....	75	67510.....	175	67744.....	162	70032J.....	110	70820.....	16
64510.....	75	67511.....	175	67746.....	162	70040.....	110	70824.....	16
64512.....	75	67512.....	175	67748.....	162	70040J.....	110	70832.....	16
646R.....	217	67551.....	176	67750.....	162	70048.....	110	71000.....	108
646RS.....	218	67553.....	176	67752.....	162	70048J.....	110	71001.....	108
646RW.....	217	67555.....	176	67754.....	162	70105.....	57	71008.....	16
646RWS.....	218	67561.....	176	67756.....	162	70105J.....	57	71010.....	16
648R.....	217	67563.....	176	67758.....	162	701.....	208	71012.....	16
648RS.....	218	67565.....	176	67760.....	162	70110.....	57	71016.....	16
648RW.....	217	67567.....	176	67762.....	162	70115.....	57	71016J.....	16
648RWS.....	218	67569.....	176	67766.....	162	70120.....	57	71020.....	16
65000.....	51	67571.....	176	67800.....	160	70120J.....	57	71020J.....	16
65002.....	51	67573.....	176	67802.....	160	70122.....	57	71024.....	16
65004.....	51	67575.....	176	67804.....	160	70125.....	57	71024J.....	16
65006.....	51	67577.....	176	67806.....	160	70125J.....	57	71032.....	16
65008.....	51	67579.....	176	67812.....	160	70130.....	57	71032J.....	16
65010.....	51	67579CAMO.....	176	67814.....	160	70135.....	57	71040.....	16
65012.....	51	67581.....	176	67816.....	160	70135J.....	57	71105.....	63
654R.....	217	67581CAMO.....	176	67818.....	160	70137.....	57	71110.....	61
654RS.....	218	67583.....	176	67820.....	160	70140.....	57	71115.....	61
66124.....	101	67583CAMO.....	176	67822.....	160	70140J.....	57	71120.....	61
66124J.....	101	67584.....	176	67824.....	160	70145.....	57	71125.....	61
66132.....	101	67585.....	273	67826.....	160	702.....	208	71135.....	61
66132J.....	101	67595.....	175	67828.....	160	703.....	208	71212.....	16
66140.....	101	67598.....	273	67830.....	160	70305.....	62	71216.....	16
66148.....	101	67600.....	174	67832.....	160	70305J.....	62	71220.....	16
66148J.....	101	67601.....	174	67834.....	160	70310.....	62	71224.....	16
66164.....	101	67602.....	174	67836.....	160	70310J.....	62	71232.....	16
66340.....	101	67604.....	174	67838.....	160	70310J.....	62	71240.....	16
66348.....	101	67608.....	174	67840.....	160	70315.....	62	71412.....	16
66348J.....	101	67609.....	174	67842.....	160	70315J.....	62	71416.....	16
66356.....	101	67611.....	174	67844.....	160	70325.....	62	71420.....	16
66364.....	101	67612.....	174	67846.....	160	70325J.....	62	71424.....	16
66400.....	51	67613.....	174	67848.....	160	70330.....	62	71432.....	16
66402.....	51	67618.....	174	68006.....	91	70335.....	62	71440.....	16
66404.....	51	67622.....	174	68008.....	91	70335J.....	62	71448.....	16
66406.....	51	67624.....	175	68010.....	91	70337.....	62	71921.....	107
66408.....	51	67625.....	175	68012.....	91	70340.....	62	71922.....	107
66410.....	51	67626.....	175	68036.....	135, 154	70345.....	62	71923.....	107
66412.....	51	67630.....	174	68037.....	154	70405.....	58	71924.....	107
66414.....	51	67632.....	174	68038.....	135, 154	70410.....	58	71931.....	107
66466.....	52	67633.....	174	68039.....	154	70415.....	58	71932.....	107
66467.....	52	67634.....	174	68040.....	135, 154	70420.....	58	71933.....	107
67005.....	75	67636.....	174	68041.....	154	70425.....	58	71934.....	107
67007.....	75	67638.....	174	68042.....	154	70430.....	58	71961.....	107
67009.....	75	67640.....	174	68044.....	135, 154	70435.....	58	71962.....	107
67400.....	122	67642.....	174	68046.....	135, 154	70440.....	58	71963.....	107
67402.....	122	67648.....	174	68047.....	154	70445.....	58	71964.....	107
67404.....	122	67650.....	174	68049.....	154	70505.....	65	72010.....	109
67405.....	122	67652.....	174	68080.....	154	70505J.....	65	72010SS.....	109
67410.....	122	67654.....	174	68084.....	154	70510.....	65	72011.....	109
67420J.....	163	67658.....	175	68096.....	135, 154	70515.....	65	72012.....	109
		67661.....	175	69001.....	135	70515J.....	65		
						70525.....	65		

7

Numerical Index

72012SS	109	74640	72	77208	19	79048	27	79629-6	44
72013	109	74648	72	77208J	19	79048J	27	79629J	44
72014	109	75608	22	77212	19	79212	27	79630	43
72015	109	75612	22	77212J	19	79212-6	27	79630J	43
72016	109	75616	22	77216	19	79212J	27	79632	43
72018	109	75812	22	77216J	19	79216	27	79632-6	43
72020	109	75816	22	77220	19	79216-6	27	79632J	43
72608	22	75820	22	77220J	19	79216J	27	79634	44
72612	22	75832	22	77224	19	79216SS	28	79634-6	44
72616	22	76012	22	77224J	19	79216SSJ	28	79634J	44
72620	22	76016	22	77232	19	79220	27	79635	44
72726	41	76020	22	77232J	19	79220J	27	79635-6	44
72736	41	76024	22	77240	19	79224	27	79635J	44
72748	41	76028	22	77248	19	79224J	27	79636	43
72808	22	76032	22	77248J	19	79224SS	28	79636J	43
72810	22	76040	22	77408	19	79224SSJ	28	79637	44
72812	22	76048	22	77412	19	79232	27	79637-6	44
72816	22	76528	80	77416	19	79232J	27	79637J	44
72820	22	76536	80	77416J	19	79240	27	79840	43
72824	22	76552	80	77420	19	79240J	27	79840J	43
72828	22	76608	19	77420J	19	79248	27	79841	44
72832	22	76610	19	77424	19	79248J	27	79841J	44
72840	22	76612	19	77432	19	79412	27	79843	44
72848	22	76616	19	77432J	19	79412J	27	79843-6	44
73012	22	76616J	19	77440	19	79416	27	79843J	44
73016	22	76620	19	77440J	19	79416J	27	79845	43
73020	22	76624	19	77448	19	79420	27	79848	43
73024	22	76736	80	77448J	19	79424	27	79848J	43
73028	22	76748	80	78606	27	79424J	27	79849	44
73032	22	76748J	80	78606SS	28	79432	27	79849J	44
73040	22	76760	80	78606SSJ	28	79432J	27	79850	43
73048	22	76760J	80	78608	27	79440	27	79851	44
73216	22	76780	80	78612	27	79448	27	79851-6	44
73220	22	76808	19	78616	27	79505	23	79851J	44
73224	22	76808J	19	78616SS	28	79505-6	23	79964	43
73228	22	76810	19	78616SSJ	28	79505J	23	79965	44
73232	22	76812	19	78808	27	79508	23	79972	43
73240	22	76812J	19	78808-6	27	79508-6	23	79980	43
73248	22	76816	19	78808J	27	79508J	23	79981	44
73416	22	76816J	19	78808SS	28	79512	23	79997	44
73420	22	76820	19	78808SSJ	28	79512-6	23		
73424	22	76820J	19	78810	27	79512J	23		
73432	22	76824	19	78810J	27	79516	23		
73440	22	76824J	19	78812	27	79516-6	23		
73448	22	76832	19	78812-6	27	79516J	23		
74002	109	76832J	19	78812J	27	79524	23		
74010	109	76840	19	78816	27	79524-6	23		
74011	109	76840J	19	78816-6	27	79524J	23		
74013	109	76848	19	78816J	27	79532	23		
74014	109	76848J	19	78816SS	28	79532-6	23		
74212	72	76944	80	78816SSJ	28	79532J	23		
74212J	72	76960	80	78820	27	79616	43		
74216	72	76968	80	78824	27	79616J	43		
74216J	72	76988	80	78824J	27	79617	44		
74220	72	76998	80	79008	27	79617J	44		
74220J	72	77008	18	79008-6	27	79618	43		
74224	72	77008-6	18	79008J	27	79618J	43		
74232	72	77008J	18	79008SS	28	79619	44		
74240	72	77010	19	79008SSJ	28	79619J	44		
74248	72	77012	18	79010	27	79620	44		
74312	72	77012-6	18	79010J	27	79620-6	44		
74316	72	77012J	18	79012	27	79620J	44		
74320	72	77016	18	79012-6	27	79622	44		
74324	72	77016-6	18	79012J	27	79622-6	44		
74332	72	77016J	18	79016	27	79622J	44		
74340	72	77020	18	79016-6	27	79623	43		
74348	72	77020-6	18	79016J	27	79623J	43		
74412	72	77020J	18	79016SS	28	79624	43		
74416	72	77024	18	79016SSJ	28	79624-6	43		
74416J	72	77024-6	18	79020	27	79624J	43		
74420	72	77024J	18	79020-6	27	79625	44		
74420J	72	77028	19	79020J	27	79625-6	44		
74424	72	77032	18	79024	27	79625J	44		
74424J	72	77032-6	18	79024-6	27	79626	43		
74432	72	77032J	18	79024J	27	79626-6	43		
74440	72	77040	19	79024SS	28	79626J	43		
74448	72	77040J	19	79024SSJ	28	79627	43		
74612	72	77048	19	79028	27	79627J	43		
74616	72	77048J	19	79032	27	79628	44		
74620	72	77156	80	79032-6	27	79628-6	44		
74624	72	77172	80	79032J	27	79628J	44		
74632	72	77196	80	79040	27	79629	44		

8

8	193
8B	193
8S	194
8SB	194
80006	53
80006-6	53
80006J	53
80007	53
80011	53
80011J	53
80014	180
80015	53
80016	53
80017	53
80017-6	53
80017J	53
80018	53
80020	53
80021	53
80022	53
80022J	53
80608	149
80609	149
80610	149
80612	149
80613	149
80614	149
80615	149
80616	149
80618	149
80620	149
80622	149
80624	149
80910	148
80911	148
80912	148
80913	148

Numerical Index

80914.....	148	85005.....	150	86633.....	156	91608.....	143	92632.....	145
80916.....	148	85006.....	150	86634.....	156	91609.....	143	92706.....	138, 142
80918.....	148	85007.....	150	86637.....	156	91610.....	143	92707.....	138, 142
80920.....	148	85008.....	150	86638.....	156	91611.....	143	92709.....	138, 142
81012SS.....	18	85009.....	150	86640.....	156	91612.....	143	92710.....	138, 142
81012SSJ.....	18	85010.....	150	86641.....	156	91613.....	143	92711.....	138, 142
81016SS.....	18	85011.....	150	86644.....	156	91614.....	143	92718.....	138, 142
81016SSJ.....	18	85012.....	150	86650.....	156	91615.....	143	92720.....	138, 142
81020SS.....	18	85013.....	150	86655.....	156	91616.....	143	93315.....	272
81020SSJ.....	18	85014.....	150	86660.....	156	91617.....	143, 154	93320.....	272
81024SS.....	18	85015.....	150	86665.....	156	91618.....	143	94006.....	271
81024SSJ.....	18	85016.....	150	86670.....	156	91619.....	143	94008.....	271
81032SS.....	18	85018.....	150	86708.....	151	91620.....	143	9410A.....	221
81032SSJ.....	18	85020.....	150	86712.....	151	91621.....	143	94312.....	271
81806.....	149	85022.....	150	86714.....	151	91622.....	143	94315.....	164
81807.....	149	85024.....	150	86718.....	151	91623.....	143	94317.....	164
81808.....	149	86209.....	152	86722.....	151	91624.....	143, 154	94320.....	164
81809.....	149	86212.....	152	86724.....	151	91625.....	143	94325.....	164
81810.....	149	86214.....	152	86814.....	151	91626.....	143	94330.....	165
81811.....	149	86216.....	152	86922.....	150	91627.....	143	94340.....	165
81812.....	149	86217.....	152	86924.....	150	91628.....	143	94352.....	270
81813.....	149	86218.....	152	86928.....	150	91629.....	143	94353.....	270
81814.....	149	86219.....	152	86934.....	150	9170F.....	154	94354.....	271
81815.....	149	86220.....	152	86941.....	150	91707.....	143, 154	94356.....	271
81816.....	149	86222.....	152	86958.....	150	91721.....	143, 154	94357.....	165
81817.....	149	86224.....	152	86980.....	159	91725.....	143, 154	94361.....	164
81818.....	149	86226.....	152	88602.....	150	91729.....	143, 154	94362.....	164
81820.....	149	86228.....	152	88703.....	150	91736.....	154	94363.....	164
81822.....	149	86232.....	152			91801.....	143	94364.....	164
81824.....	149	86234.....	152			91802.....	143	94365.....	164
82009.....	149	86236.....	152			91804.....	143	94366.....	164
82012.....	149	86238.....	152			91805.....	146	94368.....	164
82018.....	149	86240.....	152	9.....	193	91806.....	143	94369.....	164
82024.....	149	86242.....	152	9B.....	193	91807.....	146	94394.....	165
82204.....	148	86244.....	152	9S.....	194	91901.....	144	94396.....	165
82205.....	148	86246.....	152	9SB.....	194	91902.....	144	94410.....	271
82206.....	148	86248.....	152	90010.....	181	91903.....	144	94412.....	271
82207.....	148	86252.....	152	90020.....	181	91904.....	144	94422.....	110
82208.....	148	86254.....	152	90024.....	181	91905.....	144	94426.....	110
82303.....	148	86256.....	152	90028.....	181	91906.....	144	94428.....	110
82304.....	148	86258.....	152	90032.....	181	91907.....	144	94430.....	110
82305.....	148	86260.....	152	90036.....	181	91908.....	144	94433.....	165
82306.....	148	86264.....	152	90040.....	181	91909.....	144	94434.....	165
82307.....	148	86266.....	152	90050.....	181	91910.....	144	94435.....	165
82308.....	148	86268.....	152	90052.....	181	91911.....	144	94436.....	165
82404.....	148	86270.....	152	90054.....	181	91912.....	144	94454.....	271
82405.....	148	86272.....	152	90056.....	181	91913.....	144	94456.....	271
82406.....	148	86276.....	152	90058.....	181	91914.....	144	94466.....	271
82408.....	148	86280.....	152	90060.....	181	91915.....	144	94605.....	166
82608.....	26	86284.....	152	90062.....	181	91916.....	144	94606.....	166
82608J.....	26	86288.....	152	90064.....	181	91917.....	144	94607.....	166
82610.....	26	86292.....	152	90066.....	181	91918.....	144	94614.....	166
82612.....	26	86296.....	152	90068.....	181	91919.....	144	94615.....	166
82612J.....	26	86298.....	152	90072.....	181	91920.....	144	94616.....	166
82616.....	26	86301.....	153	90074.....	181	91921.....	144	94617.....	166
82616J.....	26	86302.....	153	90100.....	219	91922.....	144	94618.....	166
82808.....	26	86303.....	153	90108.....	207	91923.....	144	94625.....	166
82808J.....	26	86304.....	153	90108J.....	207	91924.....	144	94628.....	166
82810.....	26	86305.....	153	90109.....	207	91925.....	144	94635.....	166
82810J.....	26	86306.....	153	90112.....	207	91926.....	144	94636.....	166
82812.....	26	86314.....	153	90112J.....	207	91927.....	144	94638.....	166
82812J.....	26	86322.....	153	90113.....	207	91928.....	144	94639.....	166
82816.....	26	86328.....	153	90116.....	207	91929.....	144	94640.....	166
82816J.....	26	86338.....	153	90116J.....	207	91945.....	144	94641.....	166
82820.....	26	86338.....	153	90117.....	207	91949.....	144	95000.....	177
82820J.....	26	86511.....	151	90214.....	157	92050.....	148	95002.....	177
82824.....	26	86512.....	151	90215.....	157	92051.....	148	95004.....	177
82824J.....	26	86514.....	151	90228.....	157	92052.....	148	95006.....	177
83008.....	26	86522.....	152	90229.....	157	92053.....	148	95008.....	177
83008J.....	26	86528.....	153	90500.....	219	92054.....	148	95010.....	177
83010.....	26	86530.....	153	90505.....	219	92055.....	148	95012.....	177
83010J.....	26	86540.....	151	90506.....	219	92056.....	148	95014.....	177
83012.....	26	86544.....	151	90605.....	219	92057.....	148	95050.....	54
83012-6.....	26	86545.....	151, 153	91597.....	143	92058.....	148	95052.....	54
83012J.....	26	86553.....	273	91599.....	143	92500.....	138	95054.....	54
83016.....	26	86554.....	151	91600.....	143	92600.....	138	95070.....	54
83016J.....	26	86556.....	151, 153	91601.....	143	92602.....	138-139	95072.....	54
83020.....	26	86558.....	151	91602.....	143	92627.....	145	95074.....	54
83020J.....	26	86560.....	151	91603.....	143	92628.....	145	95090.....	163
83024.....	26	86566.....	151	91604.....	143	92629.....	145	95092.....	163
83024J.....	26	86618.....	156	91605.....	143	92630.....	145	95094.....	163
85004.....	150	86624.....	156	91606.....	143	92631.....	145		
		86632.....	156	91607.....	143				

9

NUMERICAL INDEX

Numerical Index

95096	163
95098	163
95100	163
95102	163
95120	177
95122	177
95124	177
95126	177
95128	177
95130	177
95132	177
95134	177
95136	177
95138	177
95150	54
95151	54
95152	54
95154	54
95156	54
95158	54
95168	54
95170	54
95190	54
95192	54
95194	54
95328	273
96000	124
96002	129
96010	125
96030	125
96035	126
96040	125
96042	154
96046	155
96047	155
96050	125
96055	129
96058	129
96059	129
96060	125
96062	129
96064	129
96066	129
96070	124
96140	125
96150	125
96160	177
96230	128
96232	129
96234	128
96236	128
96238	128
96240	128
96242	128
96244	128
96246	129
96248	129
96260	156
500100	236
500100B	236

A

A2-1/2 600	209
A2-1/2 600B	209
A0600	209
A0600B	209
A1600	209
A1600B	209
A2600	209
A2600B	209
A3600	209
A3600B	209
A4600	209
A4600B	209
A5600	209
A5600B	209
ABC25	239
APS	228
APS50	228
APS75	228

C

CBS18HC50	204
CBS18HC50APS	205
CBS18HC50ST	204
CBS18HC75	204
CBS18HC75APS	205
CBS18HC75ST	204
CBS18HC100	204
CBS18HC100APS	205
CBS18HC100ST	204
CBS18HC5018	210
CBS18HC7518	210
CBS18HC10018	210
CBS18HC50516	210
CBS18HC75516	210
CBS18HC100516	210
CBS18KC1	204

B

BA	84, 223
BA50	241
BA75	241
BAKC38	241
BAKC1234	241
BAR	211
BB	84
BBC	249
BC	84
BC18	235
BC18KC1	230
BC18KC2	230
BC18KC38	230
BC18KC112	230
BC18KC114	230
BC18KC1234	230
BC18ST	235
BC516	235
BC516KC1	230
BC516KC2	230
BC516KC38	230
BC516KC112	230
BC516KC114	230
BC516KC1234	230
BC516ST	235
BC916	235
BC916KC1	230
BC916KC2	230
BC916KC38	230
BC916KC112	230
BC916KC114	230
BC916KC1234	230
BC916ST	235
BC1850	230
BC1875	230
BC18100	230
BC51650	230
BC51675	230
BC516100	230
BD	84
BE	84
BJNP	219
BJNPH	219
BJW4	223
BJW6	223
BMB16	211
BMB16D	211
BMB24	211
BMB24D	211
BO	223
BRS2	218
BRS15	218
BS18	212
BST	213
BXC	241

D

CBS18KC1APS	205
CBS18KC1ST	204
CBS18KC38	204
CBS18KC38APS	205
CBS18KC38ST	204
CBS18KC118	210
CBS18KC1234	204
CBS18KC1234APS	205
CBS18KC1234ST	204
CBS18KC1516	210
CBS18KC3818	210
CBS18KC38516	210
CBS18KC123418	210
CBS18KC1234516	210
CC1538P(B)	260
CC1538Q	266
CC1738I	266
CC2025Q	266
CC2050Q	266
CG1525K	266
CG1538K	266
CG1538M(B)	260
CG1738K	266
CG2038M(B)	260
CG2050Q	266
CG2063T(B)	260
CG3090N(B)	260
CP1225K	265
CP1525K	265
CP1531K	265
CP1550K	265
CP1725K	265
CP2025K	265
CP2775S	265
CPRS25J	162
CULWMO9	182
CULWMO9LT	182
CULWMO45	182
CULWM123	182
CULWM130	182
CULWM190	182
CULWM190AZ	182
CULWM4690	182
CULWMABC	182
CULWMAZ	182
CULWMAZ015	182
CULWMBA	183
CULWMFA	183
CULWMINST	182
CULWML1	182
CULWMNEMA	183
CULWMRC	183
CULWMT1	182
CULWMVOLT	183

DB1538K	261
DB1538K-B50	262
DB1550K	261
DB1550K-B50	262
DB1738K	261
DB1738K-B50	262
DB1763Q	261
DB1763Q-B50	262
DB2038E-B50	262
DB2050Q	261
DB2050Q-B50	262
DB2063Q	261
DB2063Q-B50	262
DB2063S	261
DB2063S-B50	262
DB2075S	261
DB2075S-B50	262
DB2575S	261
DB2575S-B50	262
DB2588S	261
DB2588S-B50	262
DB2592S	261
DB2592S-B50	262
DB3075S	261

DB3075S-B50	262
DB3090W	261
DB3090W-B50	262
DB3095W	261
DB3095W-B50	262
DB3097W	261
DB3097W-B50	262
DB4092W-B50	262
DB4097W	261
DC1025C	263
DC1225C	263
DC1531I	263
DC1738I	263
DC2050Q	263
DC2063Q	263
DC2063S	263
DG1538K	263
DG1575E	263
DG1738K(S)	264
DG2050Q	263
DG2063Q	263
DG2063Q-#4	264
DG2063Q-#6	264
DG2090S	263
DG2588S	263
DG2590S	263
DG3090W	263
DG3090W(H)	263
DG3097W	263
DG3597W	263
DLS1	223
DR20	229
DR30	229
DR40	229
DWC1	224
DZ1738K	262
DZ1738K(S)	264
DZ2063Q	262
DZ2063Q(F)	264
DZ2063Q(F)-XZ	264
DZ2063S	262
DZ2063S(S)	264
DZ3090W	262

E

ES137S	158
ES200S	158
ES200SV	158
ES1150	158

F

F2A	229
F2B	229
F2C	229
F2D	229
F2E	229
F2F	229
F2G	229
F4A	229
F4B	229
F4C	229
F4D	229
F4E	229
F4F	229
F4G	229
F8A	229
F8B	229
F8C	229
F8D	229
F8E	229
F8F	229
F8G	229
FB06	213
FB023	213
FB0234	213
FH116	240
FH532	240
FS1	227
FS2	227

G

G100	218
GWC1	206

H

H12	202
H16	202
H16A	202
H30	198
H40	198
H45	198
H50	198
H55	198
H60	198
H65	198
H70	198
H75	198
H80	198
H85	198
H90	198
H92	198
H94	198
H95	198
H96	198
H97	198
H98	198
HD260	201
HD270	201
HD280	201
HD290	201
HD292	201
HD294	201
HD295	201
HD296	201
HD297	201
HD298	201
HIC50	225
HIC75	225
HIC100	225
HIC5050	226
HIC5075	226
HIC7575	226

I

I10A	254
I10C	254
I10G	254
I10HA	254
I10HC	254
I10HFA	254
I10HFC	254
I10HFG	254
I10HFR	254
I10HG	254
I10HR	254
I10R	254
I12A	254
I12C	254
I12FA	254
I12FC	254
I12FG	254
I12FR	254
I12G	254
I12R	254
I12S	254
I13A	254
I15A	254
IBT251B	257
IBT251W	257
INS66	257
IPN1A	255
IPN1C	255
IPN1HFA	255

Numerical Index

IPN1HFC	255
IPN1R	255
IPN2A	255
IPN2C	255
IPN2FA	255
IPN2FC	255
IPN2FR	255
IPN2R	255
IPS50A	256
IPS50C	256
IPS50E	256
IPS50P	256
IPS75A	256
IPS75C	256
IPS75D	256
IPS75P	256
IPS502	256
IPS503	256
IPS504	256
IPVC1HA	255
IPVC1HC	255
IPVC1HF	255
IPVC1HR	255
IPVC2A	255
IPVC2C	255
IPVC2F	255
IPVC2R	255
ISE13A	254
ISE14A	254
ISE18U	254
ISE22U	254
ISE23U	254
ISER10	257
ISER20	257
ISER30	257
ISER40	257
ISEU50	257
ISEU60	257
ISEU70	257
ISEU80	257

J

J200	216
J200ABC25	216
J200APS	216
J200B	216
J200B500	216
J200B600	216
J200BBC18	216
J200BBC516	216
J200BBC916	216
J200SFC18	216
J200SFC516	216
J200SFC916	216
J200VBC25	216
J200500	216
J200600	216

K

K0B	194
K1B	194
K2B	194
KC1	225
KC2	225
KC38	225
KC38KC1	226
KC38KC1225	226
KC38T	225
KC112	225
KC114	225
KC1225	225
KC1225KC1225	226
KC1225T	225
K050	181
K075	181
K0100	181
K0125	181
K0150	181
K0200	181

KOSORT	181
--------	-----

L

LSBAR	214
-------	-----

M

MED2	202
MED3	202
MED5	202
MED7	202
MED9	202
MED12	202
MED12A	202
MED13	202
MED13A	202
MED14	202
MED16	202
MED30	197
MED30SS	197
MED40	197
MED40SS	197
MED45	197
MED45SS	197
MED50	197
MED50SS	197
MED55	197
MED55SS	197
MED60	197
MED60SS	197
MED65	197
MED70	197
MED70SS	197
MED75	197
MED80	197
MED80SS	197
MED85	197
MED90	197
MED90SS	197
MINE28	197
MINE30	197
MINE40	197
MINE45	197
MINE50	197
MINE55	197

N

NC06	267
NC10	267
NC16	267
ND1900	267
ND216	267
ND217	267
ND218	267
ND317	267
ND318	267
NP3	219
NP6	219
NP6M	219
NP12	219
NP18	219

O

OR	212
----	-----

P

P	237
P50	238
P75	238
P100	238
PBA	223
PCTF	179, 248
PH	237
PH14T	238
PH38T	238
PHPSR	238

PKC1	239
PKC38	239
PKC114	239
PKC1234	239
PS50	201
PS75	201
PS100	201
PS125	201
PS150	201
PS200	201
PS250	201
PS300	201
PS400	201
PSF18	234
PSF18R	234
PSF516	234
PSF516R	234
PSF916	234
PSF916R	234

R

R14T	249
R38T	249
R1438N	249
R1814	233
R1814T	233
R1838	233
R1838T	233
R51614	233
R51614T	233
R51638	233
R51638T	233
R91614	233
R91614T	233
R91638	233
R91638T	233
RA14	232
RA14T	232
RA38	232
RA38T	232
RA1438N	232
RBAR	211
RC50	162
RC50J	162
RC75	162
RC75J	162
RF11614T	240
RF11638T	240
RF53214T	240
RF53238T	240
RO14	232
RO14T	232
RO38	232
RO38T	232
RO1438N	232
RSS	163
RSSJ	163

S

S1900	243
SB50	244
SB75	244
SB100	244
SBC	243
SBKC1	244
SBKC38	244
SBKC1234	244
SBS	244
SBS3.5	244
SBS6	244
SBX	241
SCH48	222
SCT2	215
SCT3	245
SCX1W	215
SCX1XL	215
SFC18	237
SFC18KC1	231
SFC18KC2	231

SFC18KC38	231
SFC18KC112	231
SFC18KC114	231
SFC18KC1234	231
SFC18PCTF	248
SFC516	237
SFC516KC1	231
SFC516KC2	231
SFC516KC38	231
SFC516KC112	231
SFC516KC114	231
SFC516KC1234	231
SFC516PCTF	248
SFC916	237
SFC916KC1	231
SFC916KC38	231
SFC916KC1234	231
SFC1850	231
SFC1875	231
SFC18100	231
SS	242
SS50	242
SS75	242
SS100	242
SSKC1	242
SSKC1234	242
SSS	163
SSSJ	163

T

TB	246
TB50	247
TB75	247
TB100	247
TBAR	214
TBKC1	247
TBKC38	247
TBKC1234	247
TBT	246
TS	246
TS50	247
TS75	247
TS100	247
TSKC1	247
TSKC38	247
TSKC1234	247
TST	246

V

VBC25	239
-------	-----

W

WBF1	220
------	-----

ORDERING

HOW TO ORDER

Phone

Toll Free

800-927-3293

8:00 A.M. to 5:00 P.M. CT

Fax

Toll Free

800-824-8942

Email

Ordering

Orders@minerallac.com

Symbols

3-Piece Knock-Out Seals	172
6-in-1 Economy Screwdriver	136
10 Person First Aid Kit	173
13-in-1 Ratcheting Screwdriver	136
14-in-1 HVAC Screwdriver	136
15-in-1 MEGAPRO Screwdriver, Stainless Steel	134
15-in-1 Shaftlock 2 Screwdriver	137
15-in-1 Tamperproof 2 Screwdriver	136
16-in-1 MEGAPRO Screwdriver	135
25 Person First Aid Kit	173
118° Point	
High Speed Jobber Drills	143
135° Point	
High Speed Jobber Drills	144
Trinado Heavy-Duty Drills	145

A

Accusharp® Knife Sharpener ..	157
Acoustical	
Eye Lags	52
Eye Tekes.....	52
Lighting	
Support Assembly	214
Troffer Fastener.....	245
T-Bar	
Box to T-Bar Fastener.....	214
Drop Wire Clip	215
Fasteners.....	246-247
Hanger, Two Piece.....	215
Scissor Clips, Two Piece.....	215
Twist on T-Bar Hanger.....	245
Wedge Anchors	76
Acrylic Enamel Paint	
Krylon Industrial Tough Coat.....	113
Adhesive	
Firestop	128-129
Industrial	125
Roof Cement.....	125
Silicon Sealant.....	124
Splice Kits.....	158
All Purpose Rags & Scrubs	127
Scrubs-In-A-Bucket.....	127
All Thread Rod (ATR)	
Threaded Rod.....	107
Size Reference Charts ...	250-251
Anchor Kits	
Double Drywall	78
Expander Anchor	100
EZ Anchor.....	91
EZ Toggle	89
Green Plug	96
Hangermate	106

Red Plastic Conical.....	97-98
SnapSkru	94
Tapcon	87-88
Toggler Alligator Solid Wall.....	95
Yellow Winged	99
Anchors	
Acoustical Wedge	76
Alligator Solid Wall	
Plastic Toggler	95
Double Drywall	78
Flat Head Split Bolt	79
Green Plug	96
Hollow Wall	
Phillips/Slotted	90
Phillips/Slotted with Drive Point	90
Lag Screw Shield	82
Lead, Machine Screw	83
Lead, Sheet Metal or Wood Screw	82
Nail-In	
Zamac "Hammer Drive"	78
Plastic Anchors	
Expander.....	100
Red Conical.....	97-98
Yellow Winged.....	99
Self-Drilling	
EZ Ancors	
#6 Plastic Lite	93
#6-8 Zinc Alloy.....	92
#8 Plastic.....	93
#8 Zinc Alloy	91
Triple Pack	92
Sleeve Anchor	76
SnapSkru SP Toggler	94
Steel Drop-In.....	83
Strike Set	77
Tapcon Concrete	
Flat Head Phillips	87
Hex Washer Head Slotted	88
Toggle Bolt	
EZ Toggle	89
Plastic Toggler.....	91
Toggler Snaptoggle	85
with Wings	
Truss Head	
Slotted/Square	85
Truss Head	
Phillips/Slotted	85
Round Head Slotted	86
Toggle Bolt Wings	86
Wall Dog.....	96
Wedge Anchor	80-81
Stainless Steel	80
Anti-Short Bushings	163
Auger Bits	
6" Ship	149
17" Ship.....	149
Extensions.....	149

Sharpening File	149
-----------------------	-----

B

Bar Joist Washers	223
Barricade Tape	166
Beam Clamp	
Malleable	208
Spring Steel.....	235, 237
Universal	208
Beam Clamp Assemblies	
Cable Support J Hook.....	216
Cable Tie Fastener.....	179, 248
Conduit	
Conduit & Box Support	210
Spring Steel	
Hammer On ...	230-231, 237
Set Screw	245
Steel	210
Rod/Wire Hanger	233
Strap Hangers	234
Threaded Rod Hangers	233
Belleville Washers	61
Bell Hanger Bits, Wood	148
Bell & Thermostat Staples	257
Belts	132
Bits (see Drill Bits & Driver Bits)	
Blow Twine, Polypropylene	161
Bolts	
Anchors.....	83
Cap Screws, Hex Head	
Grade 2.....	71-72
Grade 5.....	71
Silicon Bronze	73
Stainless Steel	72
Carriage Bolts.....	68
Eye Bolts with Hex Nuts.....	75
Hex Lag Screws	67
Stove Bolts	74, 221
U-Bolts	75
Box Support	
Bar	249
Beam	210
Conduit & Box	204
Wire & Rod Clip.....	214
Beam Clamp	210
Far Side.....	214, 244
Flange.....	209
Screwless	213
Stud	
Stabilizer.....	213
Mounting Bracket.....	211-212
Box to Bar	211
Fastener.....	242-243
T-Bar	214, 246
Wire	237
Brackets	223
Bridle Rings	217
Cable Support	217
Bushings	

Anti-Short.....	163
Knock-Out.....	163
Steel Stud	163, 218

C

Cable Clip	
Flexible Conduit/Cable	
Flange	227, 229
Flexible Conduit/Cable Stud... ..	241
Cable Connectors	162
Cable Protection	
Nail Plates	219
Stud Grommets	163, 218
Cable Support	
Bridle Rings.....	217-218
D-Rings.....	220
J-Hooks	216
Service Entrance	
One-Hole Straps.....	202
Two-Hole Straps.....	203
Staples	254-257
Ties.....	179
Tie Fasteners.....	179
Cable Ties	178-179
Fastener	179, 248
Kits.....	178
Mounting Bases.....	179
Mounting Ties.....	179
Tensioning Tool.....	178
Cap Screws, Hex Head	
Grade 2	71-72
Grade 5	71
Silicon Bronze	73
Stainless Steel.....	72
Cap Nuts, Specialty	59
Carbide Drill Bits	
Rotary/Percussion	147
SDS Rotary/Hammer	147
Straight Shank, Rotary Only... ..	147
Carbide Grit Hole Saws	153
Carbide-Tipped Masonry Drill Bits	87
Carbon Steel & Hex Shank Taps	
Carbon Steel Taps.....	154
Wrenches.....	154
Drill Set	154
Carriage Bolts	68
Carton Sealing Tape	165
Caulk	
Firestop	129
Gun	124, 129
Silicone	124
Caution Tape	166
Ceiling Cover Plate	172
Chain	
Double Loop Tenso	109
Jack	109
Stainless	109
S-Hooks	110

Cleaners

Contact 116
 Electronic 117
 General Purpose 120
 Glass 120
 Rags 127
 Scrubs 127
 Selection Guide 114–115

Closed Clip

Drywall, Phillips 201

Coarse Thread Screws

Drywall, Phillips 44

Common Nails

Galvanized 267
 Copperclad 267
 Size Guide 267

Concrete/Masonry Anchors

Acoustical Wedge 76
 Flat Head Split Bolt,
 Zinc-Plated Steel 79
 Lag Screw Shields 82
 Lead Machine Screw 83
 Lead Screw 82
 Nail-In
 Light Duty 79
 Zamac "Hammer" Drive 78
 Sleeve, Medium Duty 76
 Steel Drop-In 83
 Strike Set, Solid Concrete 77
 Tapcon 87–88
 Wedge 81
 Stainless Steel 80

Condrive Installation Tool

Kits 87

Conduit

Beam Clamp
 Assembly 209, 230, 236
 Clip 225, 227
 Conduit & Box
 Support 203–204, 210
 Conduit to Conduit, Trapeze ... 226
 Conduit to Stud 242, 244
 Conduit Support w/Bracket ... 241
 Conduit to T-Bar 247
 Flange Mount Assembly 240
 Flexible (see Flexible Conduit)
 Foam Pistons 162
 Hangers
 Spring Steel 225
 Stainless Steel 193, 203
 Steel 193–194
 Hubs 54
 Measuring Tape 170
 Multi-Function
 Clip Assembly 228
 Nail Straps, Flat & Round 207
 One-Hole Straps 195–198
 Stainless Steel 197
 Perforated Strapping ... 110, 222
 Reducing Washers &

Bushings 180
 Roof Jacks, Flashing 177
 Service Entrance Caps 177
 Size Reference Charts 250–251
 Sleepers, Pre-Kuts Plastic 177
 Strut Clamps, Universal 208
 Two-Hole Straps
 Plastic 201
 Stainless Steel 208
 Z Purlin Assembly 237–239

Cone Bits, 2-Flute Design

Contact Cleaner

Corrosion Compatibility

Corrosion Inhibitors

Crayons, Lumber

Crossfire Safety

Glasses

Cut Point Staples

Cutting Oil

D

Damaged Screw

Removal Set

Deck Screws

Degreaser

Contact 117
 Electronic 117
 General Purpose 120
 Selection Guide 114–115

Deep Thread

Particle Board

Dial-A-Bit Kit

Diamond

Point Staples

Displays

Accusharp® Knife Sharpener ... 272
 Cully™ Screwdriver 272
 CrossFire® 273
 Glove 273
 Gondola Header & Display ... 271
 Gravity Feed Jar
 Header & Display 270
 Hole Saw, Morse® 273
 Krylon®/Sprayon® 272
 Masonry Drill Bit 273
 Plastic Boxes 272
 Reciprocating Saw Blade,
 Morse® 273
 Shovel Hooks 273

Drill Bits

Bell Hanger 148
 Carbide
 Rotary/Percussion 147
 SDS Rotary/Hammer 147
 Straight Shank Rotary 147
 Tipped 87
 Electrician's Power Bits 148

Flex Shank (Fish) 148
 Hex 135° Split Point Set 146
 Jobber High Speed
 118° Point 143
 135° Point 145
 Sawtooth 150
 Special Set, Cobolt &
 Titanium 146
 Speedbor 2000 150
 Trinidad

135° Point Heavy Duty 145

Metal Index Set
 Heavy Duty 145

Wood, Auger
 6" Ship 149
 17" Ship 149

Extension &
 Sharpening File 149

D-Rings

Driver Bit

Accessories 139
 Dial-A-Bit Kit 139
 Drill Adaptor 139

Phillips

Hex Power 140
 Screwdriver 134–135

Pozi Drive

Slotted
 Hex Power 141
 Screwdriver 134–135

Socket Pin

Insert 138, 142
 Screwdriver 135

Spanner

Insert 138, 142
 Screwdriver 135

Square

Hex Power 140
 Screwdriver 134–135

Star Pin

Insert 138, 142
 Screwdriver 135

Tamperproof Insert

Tri-Wing

Drive Stop® Diamond

Point Staples

Drywall

Anchors 78, 84–86, 89–100
 Hole Saws 151–153
 Jab Saw 155
 Screws 43–44

Duct Seal Compound

Duct Tape

Duplex Jiffy Clip

Dust Mask

Ear Plugs

171

Electronic

Cleaners 117
 Degreasers 117
Expander Anchors 100
Eye Bolts with Hex Nuts 75
Eye Lags 52
EZ Ancors™ 91–93
EZ Toggle™ Ancors 89

F

Far Side Box Support

Fender Washers

Fiberglass

Handled Tools

Fine Thread

Finish Cup Washers

Brass 60
 Stainless Steel 60

Firestop Products

Caulk 129
 Gaskets 128
 Lectra-Stop™ 128
 Pillows 129
 Putty Pad 128
 Putty Sticks 129

First Aid Kits

10 Person 173
 25 Person 173

Fixture Hanging Hardware

Brackets 223
 Chain 109
 Hangerbolts 101
 Lighting Support Assembly ... 214
 Plumber's Tape,
 Perforated Strap 110, 222
 S-Hooks 110
 Stud Clip Adaptor 222
 T-Bar

Drop Wire Clip

Hanger, Two-Piece

Scissor Clip

Twist-On

Tie Wire

Threaded Rod

Bracket Supports

Beam Assembly

Flange Hanger

Hangermate®

Hangers

Hex Rod &

Reduced Couplings

Sammys®

Z Purlin

Troffer Fastener

V-Hooks

Flange

Cable/Conduit Clips	236, 238
Clamps, Beam	208, 237, 240
Clip, Two-Piece	209
Hanger	239-240
Multi-Function Clip	228
Flat Cut Washers	
Brass	63
Silicon Bronze	63
Stainless Steel	62
Flat Head Screws	
Machine	
Brass	50
Phillips	36
Slotted	35-36
Square	34
Stainless Steel	36
Wood, Square	39-40
Sheet Metal	
Square	21
Spanner	46
Stainless Steel	22
Flat Head Split Bolt Anchors ..	79
Flexible Conduit/Cable Clip	
Anti-Short Bushings	163
Cable Clip	227, 229
Cable Ties	178-179
Connectors	162
Hanger	193, 225
Grommets	163, 218
Knock-Out Bushings	163
Nail Plates	219
Straps	
One-Hole	195-198, 202
Two-Hole	203
Stud Fastener	241
Support	
Bridle Rings	217-218
D-Rings	220
Flex Shank Drill Bits (Fish Bits)	
Wood, Self-Feed	
Screw Point	148
Foam Conduit Pistons	162
Framing Screws	24
Friction Tape	164

G

Galvanic Corrosion	250
Gaskets, Firestop	128
Glass Cleaner	120
Gloves	
1927® Cold Weather	
Grain Pigskin	174
Fingerless Ragg Wool	175
Frostbreaker® Thermal	
Latex Gripping	175
Grain Leather Drivers	174
Kevlar® Lined	175
Latex Coated Knit	174
Lined Brown Jersey	174

Nitrile Palm Coated	175
Pro-Grip	
Full Finger	176
Half Finger	176
Mechanic's Plus	176
Mesh Utility	176
Winter Plus	176
PVC Dipped	175
Split Leather Drivers	174
Split Leather Work	174
Unlined	
Brown Jersey	174
Deerskin Drivers	174
Grain Pigskin Drivers	174
Warm Grip Latex Work	175
White	
Canvas	175
String Knit	175
Grade 2	71-72
Grade 5	
Bolts	71
Nuts	57
Grommets, Steel Stud ..	163, 218
Green Plug Anchors	96
Grounding	
Clamps	54
Clips	53, 206
Drive Stop® Staple	264
Hubs	54
Pigtails	53
Screws	53

H

Hacksaw	156
Hangerbolts	101
Hangerbolt Drivers	101
Hangermate®	
Installation Tools	107
Metal Applications	106
Sidemount Applications	107
Wood Applications	106
Hangers	193-194, 225
Beam Clamp	208, 235, 237
Bridle Rings	217-218
Chain, Jack & Tenso	109
Conduit	193-194, 225
Beam Assembly	
Set Screw	217, 236
Hammer On	230-231
Z Purlin	237-239
Eye Bolts	75
Eye Lags	52
Eye Tek's	52
Flange	247
Vertical	239-240
J-Hooks	216
Perforated Strap	110, 222
Strap Hangers	234
Threaded Rod	107

Beam Assembly	233
Bracket Assembly	232
Hangermate®	106-107
Sammys®	102-105
Vertical Flange	240
Z Purlin	237-239
Hard Hats	172
Blockhead	172
Charger™ Safety Cap	172
Liners	172
Hardware/Accessories	221-223
Hex Drill Set	146
Hex Driver Bits	141
Hex Head	
Bolts, Cap Screws	71-73
Grade 2	70
Grade 5	71
Silicon Bronze	73
Stainless Steel	72
Lag Screws	67
Hex Nuts	57
Brass	56
Flange Whiz	57
Grade 5	57
Nylock	58
Stainless Steel	58
Silicon Bronze	56
Stainless Steel	57
Hex Power Bits	
Phillips	140
Slotted	141
Square	140
Hex Rod Coupling	108
Hex Shank Taps	154
Hex Washer Head	
Sheet Metal Screw	18-19
Sharp Points	23
Tek Self-Drilling	27-28
High Speed Jobber Drills	
118° Point	143
135° Point	145
Hole Saws	
Arbors & Pilot Drills	151
Carbide Grit	153
Kits	151-153
Electrician's Hole Saw	152
Maintenance	153
Master Electrician's	153
Variable Pitch, Bi-Metal	152
Hollow Wall Anchors	84-100
Combo Phillips/Slotted	90
Drive Point	90
Expander	100
EZ Anchor®	91-93
Green Plug	96
Red Conical	97-98
SnapSkru™	94
Toggle Bolt & Wings	85-86
Toggle® Alligator®	95

Toggle® Plastic	91
Toggle® Snaptoggle®	84
Wall Dog	96
Yellow Winged	99

I

Insulated Metal Staples	
Plastic Insulator Cable	255
PVC Dipped Cable	255
Insulated Plastic Staples	
Bell & Thermostat	257
Non-Metallic	
Sheathed Cable	257
Plastic Cable	256
Service Entrance	257
Stacking Cable Staple	256
Inverted Marking Paint	
Krylon® Industrial Quik-Mark™ ..	111
Paint Accessories	119
Paint Color Selection Guide ..	112

J

Jab Saw	155
Jack Chain	109
Stainless Steel	109
J-Hooks	216
Jiffy Clip®	
One-Hole Duplex	199
One-Hole Strap	
Heavy Duty	198
K-Series	195
Medium Series	197
Min-E® Series	197
Standard Series	196
Slotted Duplex	199
Jobber Drill	143-144

K

Knife	
Sharpener, Accusharp®	157
Utility	
Quickblade	157
Titan, Folding	157
Knock-Out Bushings	163
Krylon®	111-113

L

Lag Screw	67
Lag Screw Shields	82
Lead Screw Anchors	82
Lead Machine	
Screw Anchors	83
LECTRA-STOP™, Firestop Product	128
Lighting	
Support Assembly	214

Troffer Fastener, Acoustical... 245
Line Packages..... 161
Lock Washers
 Octagonal..... 60
 Sealing..... 60
 Split..... 66
 Silicon Bronze..... 65
 Stainless Steel..... 65
 Toothed Lock Washers
 External..... 60
 Internal..... 60
Low Voltage Mounting Bracket..... 220
Lubricants..... 117–118, 124
Lumber Crayons..... 122

M

Machine Screws
 Flat Head
 Brass..... 50
 Phillips..... 36
 Slotted..... 35–36
 Square..... 34
 Stainless Steel..... 36
 Hex Head
 Grade 2..... 72–73
 Grade 5..... 71
 Silicon Bronze..... 73
 Stainless Steel..... 72
 Round Head
 Phillips/Slotted Combo .. 29–30
 Square/Slotted..... 31–32
 Stainless Steel..... 33
 Socket Pin..... 49
 Spanner..... 48
 Star Pin..... 49
 Truss Head
 Phillips/Slotted..... 37
 Square/Slotted..... 37
 Wall Plate..... 38
Malleable, Beam Clamps..... 208
Marker Books..... 182–183
Markers
 Dura-Ink® 15 Black..... 122
 Lumber Crayon..... 122
MEGAPRO® Screwdrivers
 15-in-1..... 134
 16-in-1..... 135
 Quick Change..... 135
Metal Piercing Stud Screws..... 23
Metal Stud
 Box Mounting Bracket... 211–212
 Box Stabilizer Support... 203–204
 Box to Bar Fastener..... 214
 Box to Stud Fastener..... 242

Box to Stud Support..... 243
 Bushings..... 163
 Conduit/Cable Support..... 241
 Conduit to Stud Fastener..... 244
 Conduit to Stud Support..... 242
 Far Side Box Support..... 244
 Flexible Conduit/Cable Fasteners..... 241
Mule Tape..... 160
Multi-Function Clip..... 228
 Assemblies..... 228
Multi-Purpose Closed Clip..... 201

N

Nail Plates (Safety Plates)..... 219
Nails
 Common Nails Size Guide..... 267
 Copperclad Common..... 267
 Galvanized Common..... 267
 Galvanized Marking..... 267
 Galvanized Roofing..... 267
Nail Straps
 Combo EMT/Rigid..... 207
 Round Nail Straps..... 207
Non-Insulated Metal Staples
 Cable..... 254
 Service Entrance..... 254
Non-Metallic Sheathed Cable Connectors..... 162
Non-Metallic Sheathed Cable Staples..... 257
Nuts..... 55–59
 Cap..... 59
 Flange Whiz..... 57
 Hex..... 57
 Brass..... 56
 Grade 5..... 57
 Nylock..... 58
 Stainless Steel..... 58
 Silicon Bronze..... 56
 Stainless Steel..... 57
 Wing..... 59, 221

O

Octagonal, Washers..... 60
One-Hole Duplex..... 199
One-Hole Strap..... 195–198, 202
 Heavy Duty Series..... 198
 K-Series..... 195
 Medium Series..... 197
 Min-E® Series..... 197
 Service Entrance..... 202
 Standard Series..... 196
Outlet Retainer..... 212

P

Paint & Chemicals..... 111–129
 All Purpose Rags..... 127
 Chemicals
 Adhesive..... 125
 Industrial E-6000®..... 125
 Cleaners
 Contact..... 117
 Electronic..... 117
 General Purpose..... 120
 Glass..... 120
 Selection Guide..... 114–115
 Cutting Oil, Dark..... 126
 Corrosion Inhibitors..... 119
 Degreaser
 Contact..... 116
 Electronic..... 117
 General Purpose..... 120
 Selection Guide..... 114–115
 Firestop Products
 Caulk..... 129
 Caulking Gun..... 129
 Gaskets..... 128
 Lectra-Stop™..... 128
 Pillow..... 129
 Putty Pads..... 128
 Putty Sticks..... 129
 Insect Repellents..... 121
 Insulating Varnishes..... 119
 Lubricants
 Sprayon®..... 118
 Tri-Flow®..... 124
 Sealants
 Duct Seal..... 126
 Roof Cement..... 125
 Silicone Caulk..... 124
 Sparyon® Silicone..... 124
 Stop Gap!™..... 125
 Lumber Crayons..... 122
 Markers..... 122
 Paint
 Accessories..... 112
 Acrylic Enamel..... 113
 Color Selection Guide..... 112
 Inverted Marking..... 111
 Scrubs-In-A-Bucket..... 127
 Technical Glossary..... 123
Pan Head
 Framing Screws
 Sharp Point..... 24
 Tek..... 24
 Machine Screw, Spanner..... 48
 Sheet Metal Screw
 Phillip/Slotted Combo..... 17
 Phillips, Stainless..... 18
 Spanner..... 46
 Square..... 14–15
 Stainless Steel..... 16
 Tek Sheet Metal Screws
 Phillips..... 26
 Square..... 25

Wall Dog..... 96
Particle Board Screws..... 41–42
Perforated Strapping..... 110, 222
Phillips Hex Power Bits..... 140
Phillips Screw
 Drywall
 Coarse..... 44
 Fine..... 43
 Machine
 Flat Head..... 36
 Round Head Stainless..... 33
 Sharp Point
 Framing..... 24
 Wafer Head..... 23
 Sheet Metal, Stainless..... 18
 Tek, Self-Drilling
 Framing..... 25
 Pan Head..... 26
 Wafer Head, Lath..... 28
Phillips/Slotted Screws
 Machine
 Round Head..... 29–30
 Truss Head..... 37
 Truss Head Toggle Bolt..... 85
 Sheet Metal
 Hex Washer Head..... 18
 Pan Head..... 17
 Stove Bolts w/ Nuts..... 74
Pick Mattock..... 130–131
Pillow, Firestop..... 129
Pipe Sleepers..... 177
Pipe Spacers..... 178
Pipe Wrap..... 165
Plastic Cable Tie Fastener..... 179, 248
Plastic Cable Staples..... 256
Plumber's Tape (Perforated Strap)..... 110, 222
Polyester Tape
 Conduit Measuring..... 161
 Pulling..... 160
Polypropylene
 Blow Twine..... 161
 Yellow Pull Rope..... 160
Post Hole Digger..... 130–131
Pouches & Bags..... 132
Pre-Kuts Plastic Sleepers..... 177
Purlin Hangers..... 237–239
Putty, Firestop
 Pad..... 128
 Sticks..... 129
PVC Electrical Tape..... 164

Q

Quickblade™, Utility Knife..... 157
Quick Change
 Drill Adapter..... 139

Screwdrivers, MEGAPRO®..... 135
Quickie Tie-Down 159

R

Rakes 130–131
Receptacle Shim 162
Reciprocating Saw Blades 156
Red Plastic
Conical Anchors..... 97–98
Reducing Bushings..... 180
Reducing Washers..... 180
Repellents, Insect..... 121
Rod Clips..... 227–228
Rod Couplings..... 108
Rod Hangers 249
Rod to Flange Hanger 240
Rod/Wire, Hangers
 Beam Assemblies..... 233
 Bracket Support 232
Roof Cement 125
Roof Jacks (Flashings)..... 177
Rotary Carbide Drill Bits..... 147
Round
 Head Machine Screw
 Brass 50
 Phillips/Slotted 29–30
 Square/Slotted 31–32
 Stainless Steel 33
 w/ Hex Nuts 74, 221
 Head Toggle Bolts, Slotted 86
 Nail Straps, Combo
 EMT/Rigid..... 207
 Washer Head, Sheet Metal
 Screw, Square..... 20
Rubber Tape..... 164

S

Safety
 Barricade & Caution Tape 166
 Dust Masks 171
 First Aid Kits 173
 Glasses
 Crossfire® 167–168
 Cobra..... 168
 Core..... 168
 ES4..... 167
 ES5..... 167
 Infinity..... 167
 KP6..... 168
 RPG..... 168
 Sniper..... 167
 HellRaiser™ 170
 Nemesis™ 169
 RX™ 169
 VI™ 169
 OTG (Over the Glasses)..... 170

Smith & Wesson® 170
 Gloves..... 174–176
 Hard Hats 172
 Hearing Protection..... 171
 Vests 171
Sammy's® Anchoring System
 for Concrete
 Horizontal Mounting 104
 Vertical Mounting 104
 for Steel
 Horizontal Mounting 103
 Vertical Mounting 103
 for Wood
 Horizontal Mounting 102
 Vertical Mounting 102
 Sammy® X-Press..... 105

Saw
 Hacksaw 156
 Hole Saw..... 151–153
 Jab Saw 155
 PVC Cable Saw..... 156
 Reciprocating Saw Blades 156
Sawtooth Self-Feeding Bits... 150
Screwdrivers..... 134–137
 6-in-1 Economy 136
 13-in-1 Ratcheting 136
 14-in-1 HVAC 136
 15-in-1..... 134
 15-in-1 Shaftlock 137
 15-in-1 Tamperproof 2 136
 16-in-1 Tamperproof 135
 Spanner 137
 Un-Do-It..... 137

Screws
 Acoustical Eye
 Lags & Teks 52
 Deck, Woodex® 45
 Drywall..... 43–44
 Cap Screws, Hex Head 71–73
 Silicon Bronze 73
 Stainless Steel 72
 Extractions
 Damaged Screw
 Removal Set..... 155
 Screw Extractor & Drill Bit.. 155
 Eyes Lags..... 52
 Framing Sharp & Tek 24
 Green Grounding 53
 Grounding 53
 Hooks..... 51
 Machine
 Brass 50
 Flat Head 34–36
 Stainless Steel 36
 Round Head 29–32
 Stainless Steel 33
 Truss Head..... 37
 Socket Pin..... 49
 Spanner 48

Star Pin..... 49
 Lag, Hex..... 67
 Particle Board..... 41–42
 Sharp Points
 Hex Head 23
 Wafer Head 23
 Sheet Metal
 Flat Head, Square..... 21
 Stainless Steel 22
 Hex Washer Head
 Phillips/Slotted Combo 18
 Slotted 19
 Oval, Square Stainless..... 22
 Pan Head 14–22
 Phillips/Slotted Combo 17
 Phillips, Stainless 18
 Square Drive 14–22
 Stainless..... 16
 Socket Pin..... 47
 Spanner Head 46
 Star Pin..... 47
 Tamperproof..... 46–49
 Tek Self-Drilling 25–28
 Hex Washer Head 27–28
 Stainless Steel 28
 Pan Head 25–26
 Wafer Head Lath 28
 Wall Plate 38
 Wood
 Flat Head 21, 39–40
 Trim Head 41

Scrubs-In-A-Bucket® 127
SDS Rotary/Hammer
 Carbide Drill Bits..... 147
Sealants
 Duct Seal 126
 E-6000® Industrial Adhesive.. 125
 Sprayon® Clear Silicon..... 124
 Wet Patch Roof Cement..... 125
 White Lightening® Silicon 124
 White Lighting® Stop Gap!™.. 125
Sealing Washers 60

Service Entrance
 Caps..... 177
 Staples..... 254, 257
 Straps
 One-Hole..... 202
 Two-Hole 203
Setting Tool 83
Steel Drop-In Anchors 83
Sharpener, Knife 157
Sheet Metal Screws
 Flat Head, Square..... 21
 Stainless Steel 22
 Hex Washer Head
 Phillips/Slotted Combo 18
 Slotted 19
 Oval, Square Stainless..... 22
 Pan Head..... 14–18
 Phillips/Slotted Combo 17

Phillips, Stainless 18
 Square 14–16
 Round Washer Head, Square.... 20
S-Hooks..... 110
Shim Receptacle 162
Shovels, Fiberglass
 Handled 130–131
Sledge Hammers,
Fiberglass Handled 130–131
Sleeve Anchors,
Concrete/Masonry 76
Slotted
 Duplex Jiffy Clip® 199
 Hex Power Bits 141
 Screwdriver & Insulated 138
 Screws, Machine
 Brass 50
 Flat Head 50
 Round Head 50
 Flat Head 35–36
 Stainless Steel 36
 Round Head, Stainless 33
 Toggle w/ Wing 86
 Wall Plate..... 38

Small-Head Shovel 130–131
Snap-In Knock Out-Seals 172
Socket Pin
 Insert Bits..... 142
 Machine Screws..... 49
 Sheet Metal Screws..... 47
Spacer, Wiring Device..... 162
Spanner
 Drive & Un-Do It Tool 137
 Machine Screws..... 48
 Insert Bits..... 142
 Sheet Metal Screws..... 46

“Spark Plugs” Hearing
Protection 171
Speedbor 2000™ Wood Bits... 150
Split Lock Washers 66
 Silicon Bronze 65
 Stainless Steel 65

Sprayon®
 Blast ‘Em Wasp & Hornet..... 121
 Contact Cleaner
 Selection Guide 114–115
 Clear Silicone 124
 Cutting Oil 118
 Electric Motor Degreaser 117
 Electrical Cleaner &
 Lubricating 117
 Electrical Degreaser,
 Non-Chlorinated 117
 Electronic Contact Cleaner.... 116
 Environmental
 Contact Cleaner..... 116
 and Degreaser 117
 Flash Free Safety Solvent &
 Degreaser 116–117
 General Purpose Cleaner 120

Heavy Duty Foaming Degreaser,
Neutra-Force® 120

Heavy Duty Glass Cleaner 120

Heavy Duty Open
Gear/Wire Rope Lube 118

Insect Repellents 121

Insulating Varnish 119

Long Term Indoor
Protectant & Lube 119

Lubricant, 711® Protector™ ... 118

Plastics Contact Cleaner 116

Rust Breaker™, Penetrant 118

Silicone Lube, Premium 118

Zinc Rich Cold
Galvanizing Compound 119

**Spring Steel Washers,
Belleville** 61

Square Drive

Deck Screws, Woodex®
All-Weather 45

Hex Power Bits 140

Machine Screw, Flat Head 34

Screwdrivers 137

Sheet Metal Screw
Flat Head 21
Stainless Steel 22
Oval Head, Stainless 22
Pan Head 14–16
Stainless Steel 16
Round Washer Head 20

Tek Self-Drilling Screw 25

Wood Screw
Deep Thread,
Particle Board 41–42
Flat Head 39–40
Trim Head 41

Square/Slotted Machine Screws
Round Head 31–32
Truss Head 37

Staples
Residential
Insulated 255–257
Bell & Thermostat 257
Non-Metallic Sheathed
Cable 257
PVC Dipped Cable 255
Plastic Insulator Cable 255
Plastic Cable 256
Service Entrance
SER 257
SEU 257
Stacking Cable 256
Non-Insulated
Cable 254
Service Entrance 254

Utility
Cut Point 260, 265–266
Copperclad 266
Galvanized 266
Pre-Galvanized 265
Square Wire Barbed 260

Diamond Point 261–264
Bright Wire 261–262
Copperclad 263
Drive Stop® 264
Electo-Zinc 262
Flat Top 264
Serrated 264
Galvanized 263
Double Barbed 263
Serrated 264

Star Pin
Insert Bits 142
Machine Screws 49
Sheet Metal Screws 47

Steel Drop-In Anchors 83

Steel Stud
Box Mounting Bracket 211–212
Box Stabilizer Support 203–204
Box to Bar Fastener 211
Box to Stud Fastener 242
Box to Stud Support 243
Bushings 163
Conduit/Cable Support 241
Conduit to Stud Fastener 244
Conduit to Stud Support 242
Far Side Box Support 244
Flexible Conduit/Cable
Fasteners 241

Step Drills, 2-Flute Split Tip 151

Stove Bolts
Slotted/Phillips
with Hex Nuts 74, 221
Stainless Steel w/ Nut 221

Straight Shank
Carbide Drill Bits 147

Strap Hangers 234

Strapping Tape 165

Strike Set Anchors, Concrete 77

Stud Clip Adapter 222

Suspenders 132

T

Tamperproof
15-in-1 Screwdriver 136
29-in-1 Driver Kit 138
Driver Bits 138
Insert Bits 142
Machine Screws 48–49
Sheet Metal Screws 46–47

Tape
Barricade & Caution
Caution-Caution-Caution 166
Caution High Voltage 166
Gas Line Below 166
Black PVC Electrical 164
Carton Sealing 165
Color-Coded PVC Electrical 164
Conduit Measuring 161

Duct 165
Friction 164
Mule/Pulling 160
Plumbers Perforated
Strap 110, 222
Pipe Wrap 165
Rubber 164
Strapping 165
Underground
Burial 166
Detectable 166

Tape Measure 159

T-Bar
Box Hanger Assembly 214
Drop Wire Clip 215
Fasteners 245–247
Flange Clip 209
Hanger, Two-Piece 215
Lightening Support
Assembly 214
Scissor Clip 215
Twist on Hanger 245

Tek Self-Drilling Screws
Framing 25
Hex Washer Head 27–28, 31
Pan Head Tek 25–26
Stainless Steel 28

Threaded Rod 107
Bracket Support 232
Coupling 108
Hangers 249
to Beam Assembly 233
to Vertical Flange Assembly 240
to Z Purlin Assembly 238

Tie Wire 108

Toggle Bolts
EZ Toggle™ Ancors 89
Truss Head 85
Round Head 86
Wings 86

Toggle®
Alligator® Wall Anchors 95
Plastic Toggle 91
SnapSkrü™ Anchor 94
Snaptoggle® Toggle Bolt 84

Tool Bags & Accessories 132–133

Tool Kits
Carbon Steel Taps 154
Hex Shank Taps 154
Hole Saws
Electrician's Hole Saw Kit 152
Maintenance Kit 153
Master Electrician's Kit 153
Screw Extractors 155
Tamperproof 138
Tapcon™ Condrive Installation 87
Uralseal Splice Kits 158

Tools

Anchor Setting 83
All Purpose Bar
w/Tamper 130–131
Bags & Accessories 132–133
Blow Twine 161
Cable Management 162–163
Caulk Gun 124
Condrive Installation 87
Conduit Measuring Tape 161
Drill Bits 87, 146–151
Driver Bits 138–142
Dust Masks 171
Ear Plugs 171
Firestop Caulking Gun 129
Foam Conduit Pistons 162
Gloves 174–176
Hangerbolt Driver 101
Hangermate Installation 107
Hard Hats 172
Hole Saws 152–153
Knives & Accessories 157
Line Packages 161
Marking Wand 112
Picking Mattock 130–131
Post Hole Digger 130–131
Pull Rope 160
Pulling Tape 160
Rakes 130–131
Safety Glasses 167–170
Safety Vest 171
Sammys® Nut Driver 102–104
Sammys® Universal X-Press 105
Saws 155–156
Screwdrivers 134–137
Shovels 130–131
Sledge Hammer 130–131
Splice Kits 158
Tape 164–166
Tape Measure 159
Tie Down Straps 159
Utility Probe 130–131

Toothed Lock Washers
External 60
Internal 60

**Tri-Flow Lubricants
with PTFE** 124

Trim Head Wood Screws 41

Trinado Heavy-Duty Drills 145

Truss Head Machine Screws
Phillips/Slotted 37, 85
Square/Slotted 37–85

**Truss Head SMS,
Square Screws** 20

Twist on T-Bar Hanger 245

Two-Hole Metal Conduit Strap
Heavy-Duty 201
Metal 200
Plastic 201
Service Entrance 203

U

U-Bolts	75
Underground	
Burial Tape	166
Detectable Tape.....	166
Grounding Clamps.....	54
Splice Kits	158
Universal Clamps	
Beam	208
Uruseal Splice Kits	157
Utility Knives	157
Utility Probe	
Fiberglass Handled	130–131

V

Variable Pitch Hole Saws	152
V-Hooks	110
Voice/Data & Low Voltage	
Cable Protection	
Nail Plates.....	219
Cable Support	
Bridle Rings	217–218
D-Rings.....	220
J-Hooks	216
Low Voltage	
Mounting Bracket.....	220
Metal Stud Grommet	163
Wing Nut Washer.....	221

W

Wafer Head Screws	
Tek, Lath	28
Sharp Point.....	23
Wall Plate	
Insulating Gasket.....	180
Mounting Bracket.....	220
Screws.....	38
Washers	
Belleville	
Spring Steel	61
Stainless Steel	61
Fender.....	64, 66
Stainless Steel	64
Finish Cup	
Brass	61
Stainless Steel	61
Flat Cut	62
SAE Flat Cut.....	64
Brass	63
Silicon Bronze	63
Stainless Steel	642
Octagonal	60
Sealing.....	60
Split Lock Washers	66
Silicon Bronze	65
Stainless Steel	65
Toothed Lock Washers.....	60
Wedge Anchors	81

Stainless Steel.....	80
Wet Patch Roof Cement	125
White Lighting®	
Silicone Sealant	124
White Lightning® Stop Gap!™ ..	125
Wiring Device Spacer	162
Wing Nut	59
Wing Nut Washer	221
Wire & Cable	
Marker Books	182–183
Wood Drill Bits	
Auger	
6" Ship	149
17" Ship	149
Bit Extensions	149
Sharpening File.....	149
Bell Hanger	148
Self-Feed Screw Point	
Electrician's Power	148
Flex Shank Drill (Fish Bits)....	148
Sawtooth Self-Feeding	150
Sharpening File	149
Speedbor 2000™ Wood.....	150
Woodex® Deck Screws,	
Square	45
Wood Hole Saws	151–153
Wood Screws	
Deep Thread	
Particle Board.....	41–42
Flat Head.....	39–40
Trim Head.....	41

Y

Yellow Polypropylene Rope	160
Yellow Winged Anchors	99

Z

Zamac Nail-In Anchors	78
Z Purlin	
Flange Hanger	239
Hanger	237
Assemblies	237–239

