

FIGURE A

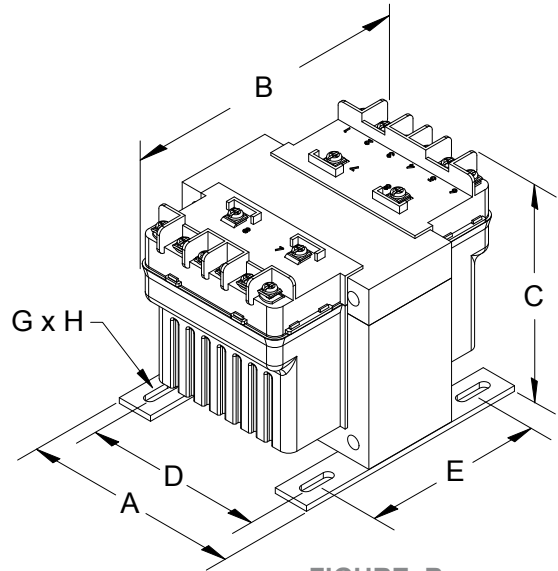

FIGURE B

Group E

Primary Voltage: **208 x 416** || 200 x 400 || 190 x 380
 Secondary Voltage: **120 x 240** || 115 x 230 || 110 x 220



50/60 Hertz

VA Rating	Catalog Number	Mtg. Fig.	Output Amps	Overall Dimensions			Mounting Centers		Mounting Slot	Height with Finger Guard	Depth with Finger Guard	Approx. Ship Weight Lbs.	Optional Primary Fuse Kit P/N
				A	B	C	D	E	G X H				
50	PH50SP	A	0.42/0.21	3.00	4.38	3.19	2.50	2.25	0.22 x 0.44	4.00	5.82	3.50	PFK1
75	PH75SP	A	0.63/0.31	3.25	3.88	3.56	2.63	2.50	0.22 x 0.44	4.37	5.32	3.54	PFK1
100	PH100SP	A	0.83/0.42	3.25	4.19	3.63	2.63	2.63	0.22 x 0.44	4.44	5.63	4.50	PFK1
150	PH150SP	B	1.25/0.63	4.00	4.94	3.81	3.38	2.75	0.22 x 0.75	4.50	6.44	5.70	PFK2
250	PH250SP	B	2.08/1.04	4.50	5.44	3.81	3.75	3.13	0.22 x 0.75	4.50	6.94	7.50	PFK2
350	PH350SP	B	2.92/1.46	4.50	5.19	4.44	3.75	3.75	0.22 x 0.75	4.94	6.69	10.1	PFK3
500	PH500SP	B	4.17/2.08	4.75	5.94	4.31	4.06	3.81	0.31 x 0.94	4.81	7.44	14.2	PFK3
750	PH750SP	B	6.25/3.13	5.13	6.69	4.31	4.38	4.31	0.31 x 0.81	4.81	8.19	16.6	PFK3
1000	PH1000SP	B	8.33/4.17	5.25	6.81	4.94	4.50	4.44	0.31 x 0.81	5.56	8.31	23.6	PFK3

Secondary fuse clips, fuse clip mounting screws, voltage links/jumpers and primary voltage links supplied standard with transformers up to and including 1000VA. Refer to page 56 for wiring schematic drawing. Special voltages and VA sizes available upon request.

All dimensions in inches

CONTROL TRANSFORMER SELECTION

Selecting a Control Transformer requires that you have first hand knowledge of the application for the transformer and that you understand some basic terms related to the selection process. By using the following information, you will be sure to select the HPS Control Transformer which best meets your application.

The HPS Emperor Series machine tool control transformers are specifically designed for high inrush applications requiring reliable output voltage stability. Designed to meet industrial applications where electromagnetic devices such as relays, solenoids, etc. are used, the HPS Emperor series transformers maximize inrush capability and output voltage regulation when electromagnetic devices are initially energized.

To select the proper transformer, three characteristics of the load circuit must first be determined. They are total steady-state (sealed) VA, total inrush VA, and inrush load power factor.

1 (A). The total steady state “sealed” VA is the amount of VA that the transformer must supply to the load circuit for an extended length of time. Simply add the total steady-state VA of all devices in your control circuit. The operating VA data of these components is available from the manufacturers.

1 (B). The total inrush VA is the amount of VA that the transformer must supply for all components in the control circuit which are energized together. Some consideration to the start-up sequence may be required. Inrush VA should be obtained from the device manufacturer.

1 (C). The inrush load power factor is difficult to determine without detailed vector analysis of all the control circuit components. Such information is not generally available.

Therefore, HPS is recommending that a value of 40% power factor be utilized. Although some other control transformer manufacturers still recommend a power factor of only 20%, HPS, through recent tests conducted on many popular brands of control devices, has determined that the 40% power factor value is more accurate.

Once the above circuit variables have been determined, transformer selection is a six step process.

SIX EASY STEPS

1. Determine what your Primary (supply) and Secondary (output) voltage requirements are, as well as your required frequency (i.e. 60 Hz)

2. Calculate the Total Sealed VA of your circuit. (See Step A)

3. Now calculate the Inrush VA by adding the inrush VA of all components being energized together. Remember to add the sealed VA of all components that do not have inrush VA, (lamps, timers etc.) as they do, however, present a load to the transformer during maximum inrush. If the inrush for the components in your circuit are not known, assume a 40% Inrush Power Factor.

4. Calculate the Total Inrush VA using one of the two methods:

A.
$$\sqrt{\text{Total Inrush VA} = (\text{VA sealed})^2 + (\text{VA inrush})^2}$$

OR

B.
$$\text{Total Inrush VA} = \text{VA Sealed} + \text{VA Inrush}$$

Note: method B will result in a slightly larger transformer being selected.

For VA sealed definition please refer to 1 (A).
For VA inrush definition please refer to 1 (B).

5. If the nominal supply voltage does not fluctuate more than 5%, then reference the 90% secondary voltage column in the Regulation Data Table for the correct VA rating.

If the supply voltage varies upwards of 10%, the 95% secondary voltage column should be used to size the transformer.

Current standards require electromagnetic devices to operate reliably at a minimum of 85% of their rated voltage. However, contact life may be affected with continuous start-ups at that voltage level. Therefore, the minimum 85% secondary voltage column should only be used as a reference.

6. Using the regulation data tables below, select the appropriate VA rated transformer:

A) With a continuous VA rating that is equal to or greater than the value in Step 2.

B) With a maximum inrush VA equal to or greater than the value obtained in Step 4.

To determine the correct HPS Transformer and its Catalog Number, just refer to the tables in this catalog for the voltage ratings, frequency and corresponding VA required.

**“HPS EMPEROR”[®] TRANSFORMERS
REGULATION DATA TABLE**

Continuous VA Transformer Nameplate Rating	Inrush VA @ 40% Power Factor		
	85% Secondary Voltage	90% Secondary Voltage	95% Secondary Voltage
50	330	259	192
75	350	258	170
100	620	467	321
150	895	699	512
250	1596	1229	880
350	2464	1889	1345
500	3939	2854	1819
750	6422	4778	3228
1000	9642	7102	4530
1500	12797	9018	5489
2000	17633	12656	7865
3000	37406	26217	15940
5000	55629	38788	23601

It is recommended that a Control Transformer be sized at a 40% Power Factor. Some components in a circuit, such as electromagnetic devices, typically operate at that level due to their inherently lower power factor. Selecting a transformer at 40% Power Factor will more than adequately size the unit for all the various loads in the circuit.



HPS Imperator® Series Control Transformer - Applications

The Perfect Solution

The HPS Imperator series of machine tool industrial control transformers are specifically designed to meet the high inrush industrial applications where electromagnetic components such as relays, solenoids etc. are used.

With 11 standard voltage groups, a VA range from 50VA to 5000VA and available with standard secondary and optional primary fuse kits, the HPS Imperator series from HPS provides the perfect solution for any applications.

Superior Quality and Value

The HPS Imperator series design, utilizing superior insulation systems and being constructed with high quality silicon steel laminations for optimum performance, will meet or exceed UL and CE standards.

Backed by an industry leading LIFETIME warranty, the HPS Imperator® industrial control transformer line offers superior performance, quality and value.

Innovative Design

The HPS Imperator series is a unique, fresh and innovative compact design that provides the ideal solution for any industrial control application and will change the way the industrial machine tool industry looks at the control transformer.

The HPS Imperator's unique terminal block design (patent pending) allows for the quick and easy installation of standard secondary or optional primary 13/32" x 1 1/2" midget/type CC fuse clips on every unit. This is the simplest and most inexpensive fusing installation provided on any industrial control transformer in the market today.

The windings and internal terminations of the HPS Imperator are encapsulated, which protects them from moisture, dirt and other airborne contaminants. The custom molded coil covers with their unique 'fin shaped' design combine superior transformer cooling properties with a clean bold look.

The HPS Imperator utilizes custom serrated terminals, in combination with standard SEMS washer screws making assembly easier and quicker to install; and provides superior connection strength when connecting with bare, solid or stranded wire. It also allows for ring or spade termination connectors.

STANDARDS		
HPS Industrial and Machine Tool Control and Instrument Transformers meet or exceeds the standards established by UL, IRC, ANSI, NEMA.		
<u>Standard</u>	<u>File #</u>	<u>VA Size</u>
UL (ANSI/UL 506)	E50394	All PH
IEC 61558		All PH (excluding PH***AJ & PH***AR)
NEMA (ST-1)		All PH

At HPS, we rate the VA capacity of our transformers at the output where it counts. Other transformer manufacturers rate their capacity on the input side of the transformer, which can result in a 5% to 20% lower actual VA at the output.



FEATURES & BENEFITS

- 600V class, machine tool rated industrial control transformers
- 11 standard multi primary and secondary voltage groups available¹
- 50/60 Hertz (60Hz on PH***AJ & PH***AR)
- VA range from 50 to 5000¹
- Superior insulation system
 - 50-150VA, temperature rise 55°C, insulation class 105°C
 - 250-1500VA, temperature rise 80°C, insulation class 130°C
 - 2000-5000VA, temperature rise 115°C, insulation class 180°C
- Constructed with high quality silicon steel laminations that provide optimum performance and reliability
- Encapsulated coils (up to and including 1500VA) encased in a custom injection molded cover, protects coils and terminations from moisture, dirt and other industrial airborne contaminants.
- Mounting Feet: made of heavy steel and welded or bolted to the core, these mounting feet provide superior strength in a compact design.
- Termination: combination slot/Philips #6 screw, complete with SEMS washer (suitable for 18 AWG to 14 AWG solid or 14 AWG stranded wire)
- Standard SEMS washers - supplied on all units up to and including 1500VA²
- Standard secondary fuse kits -utilizing 13/32" x 1 1/2" midget/type CC fuse clips (supplied with all standard units up to and including 1500VA)
- Optional primary fuse kits available utilizing 13/32" x 1 1/2" midget/type CC fuse clips (available on all standard units up to and including 1500VA)
- Optional finger safe terminal covers available on all units up to and including 1500VA
- UL Listed (approved for U.S. and Canada)
- CE Mark standard on all molded units up to and including 1500VA
- LIFETIME Warranty (Limited)
- RoHS Compliant

¹ special voltages and VA sizes available upon request
² excluding PH750PG, PH1000PG, PH750MLI, PH1000MLI

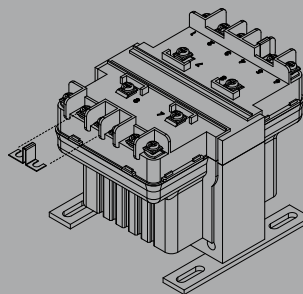
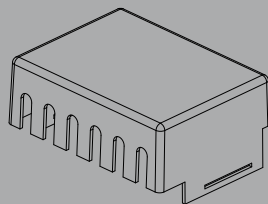
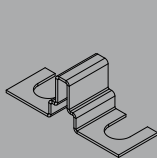
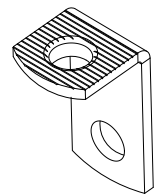
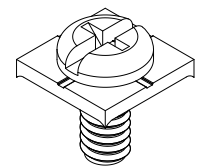

WARRANTY

Lifetime

FEATURES & BENEFITS CONTINUED

Terminal connection numbers molded into the terminal block and correspond to the nameplate and wiring diagrams which makes connecting the HPS Imperator quick and simple.



Standard secondary and optional primary fuse kits utilizing 13/32" x 1 1/2" midget/type CC fuse clips provide an economical solution to your fusing requirements (fuses not available).

Innovative terminal block design (patent pending) provides for easy hook-up and installation of fuse clips.



Optional removable finger safe terminal covers available on all units up to and including 1500VA.

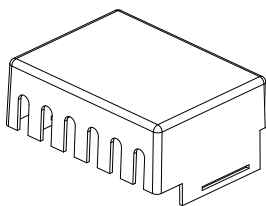

Custom injection molded coil cover with its unique "fin shaped" design combines superior cooling properties with a clean, bold look.

Made of heavy steel and welded or bolted to the core, these mounting feet provide superior strength in a compact design.