

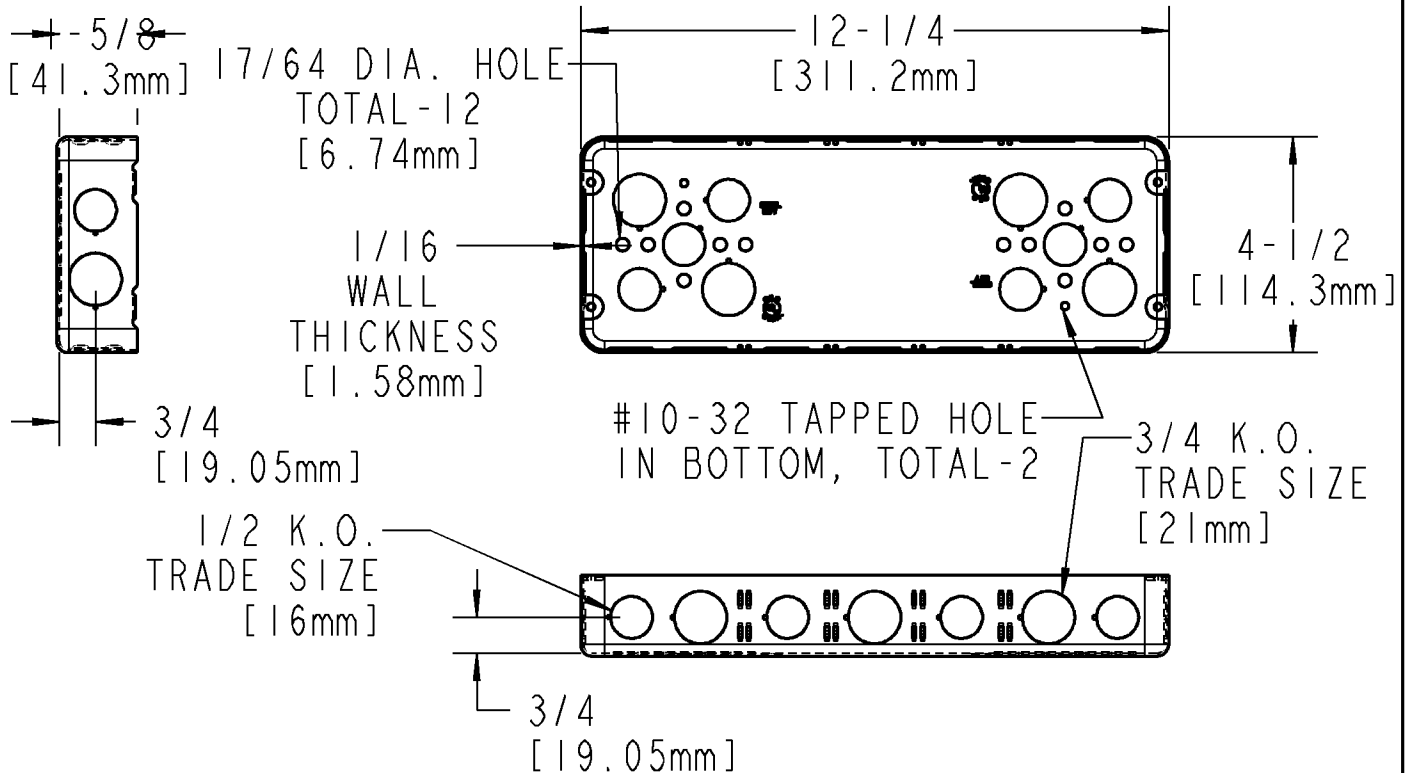

Thomas & Betts

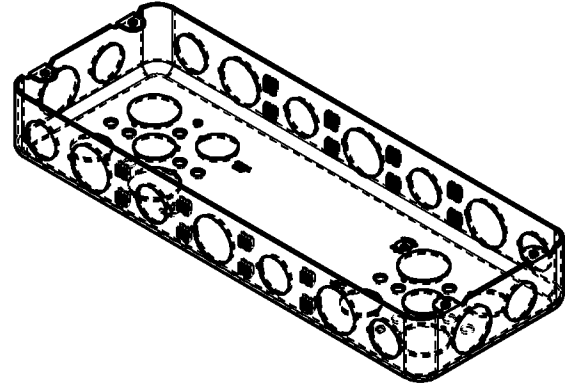

85.0 CU. IN
 [1392.9 CU. CM]

CAT. NO. 5G 1/2 3/4

TYPE OF K.O.	SIDES	ENDS	BOTTOM	TOTAL
NO. OF 1/2 K.O. 'S	8	2	6	16
NO. OF 3/4 K.O. 'S	6	2	4	12

GENERAL NOTES

- ALL DIMENSIONS ARE FOR REFERENCE ONLY.
- DIMENSIONS IN BRACKETS [] ARE IN METRIC UNITS.

www.tnb.com

Thomas & Betts

A Member of the ABB Group

REVISIONS

- | | |
|---|---|
| 0 | SEE ERN (****) FOR APPROVAL SIGNATURES & RELEASE DATE. PROJECT NO: **** |
|---|---|

DESCRIPTION:

**5G 1/2 3/4
 GANG BOX**

ORIGINAL PROJECT NO / (ERN NO)

NM400367 / (2015599)

SHEET NO:

1 OF 1

REV. NO:

0

DRAWING NO:

WSD-001290

Overview

Steel City® Metallic Boxes and Covers

Steel City® is the industry-leading product line of metallic switch and outlet boxes used in electrical construction. Since 1904, Steel City® products have symbolized the highest quality standards in manufacturing and innovative design, with one of the most complete offerings available.

Steel City® products are known for their simple improvements, such as being the first box offering to standardize combination slotted/phillips screws on all boxes. Thomas & Betts is also recognized as a leader in design innovation, as in our new metal stud bracket.

Thomas & Betts continues to listen to contractors and responds to their ever-changing needs. Contact a T&B distributor nearest you to select the right Steel City® product for your requirements.

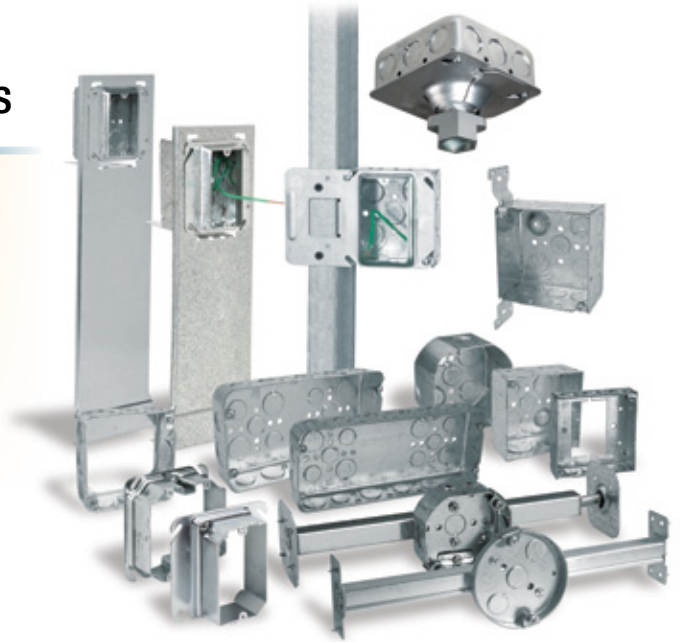

Advantages of Steel City® Boxes and Covers

Notched Ears on Switch Boxes

- Steel City® Switch Boxes feature a longer ear and a special notch. This provides clearance for the screws that are used to attach wall plates to GFCI or rocker-type light switches

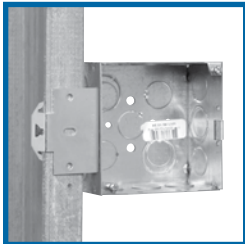

MS Bracket Boxes

- Mounts without the use of screws
- Mounts to the open or closed side of the stud
- Works on stud depths up to 4"

Eccentric Knockouts on Square Boxes

- Provide better contact with conduit fitting and locknut to the box, improve grounding path, stronger than 3/4" knockout
- Available in all four standard-size square boxes
- Improved 3/4" knockout position on square boxes
- Less labor required to install 3/4" conduit to box

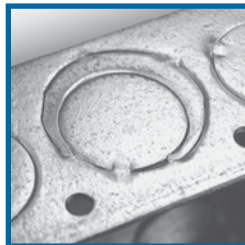

Raised Ground Screw Bump in 4" Square, 4 1/16" and Utility Boxes

- Quicker surface mounting by eliminating the need to remove the portion of the screw that threads through the back of the box
- Allows for improved repositioning of grounding conductor
- Ground bump standard in 2 1/8" boxes
- Ground bump optional in 1 1/2" boxes



Pre-Installed Screws are Packaged in Raised Position

- Eliminates extra step of having to back out the screw during cover installation

Steel City® switch and outlet boxes are protected from rust and corrosion by zinc-galvanizing. All clamps and other component parts are electrogalvanized separately, before assembly in the box, to ensure corrosion protection of every surface. Steel City® galvanized finish meets the requirements of Underwriters Laboratories, Inc. and Federal Specifications.

Overview

Guide to Steel City® Knockouts, Pryouts, Ears, Brackets and Clamps

Knockouts and Pryouts

Steel City® conduit KOs have standard trade size dimensions. KOs are uniform and true for attachment of cable or conduit connectors. Pryouts for cable entrance are slotted — a twist with a screwdriver removes them. KOs and Pryouts are precision stamped to permit easy removal, but remain sufficiently strong and sturdy when not removed.

Outlet Box Ears

Mounting ears support the box independent of the electrical system attachments. Switch boxes have a fixed ear for old work installations.

Ears for plaster are set 1/16" forward of the box face in position for old work (modernization), except where specifically noted.

Tapped Holes for Grounding

All Steel City® boxes have a 10-32 tapped hole in the bottom of the box for attaching separate ground wire.

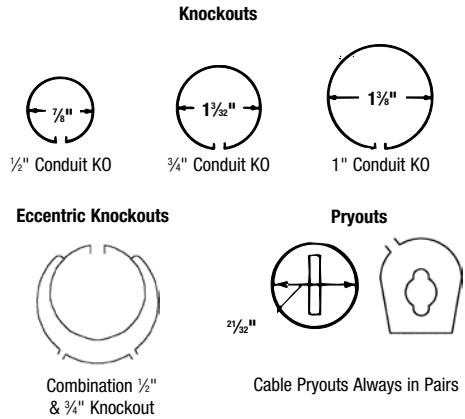

Brackets

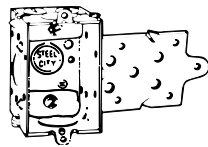

S or B Type
Mounts to face of stud. Used on switch, handy or square boxes. 2" long x 2 1/8" wide

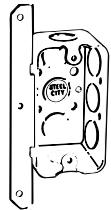

T Type
Positions handy box against the face and side of stud. 5 1/2" long x 3/8" wide

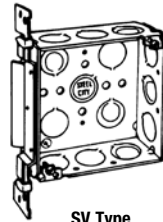

SV Type
Mounts box to side of stud with positioning spikes. 7 3/8" long x 1" wide x 3/8" offset

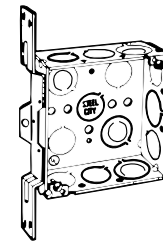

CV Type (Outlet Boxes)
Mounts to flat side of metal studs or wood studs. 7 3/8" long x 1" wide x 3/8" offset

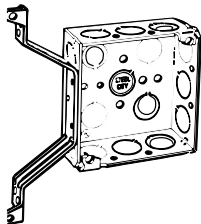

DV Type
Mounts box offset from stud 1 1/2". 6 3/8" long x 1" wide x 1 1/2" offset

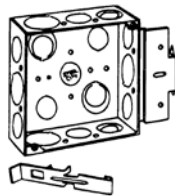

MS Type (For Metal Studs)
Mounts to any depth of metal stud, open or closed side. 2 1/2" long x 1 1/16" wide x 3/8" offset; Far side support to 4" only

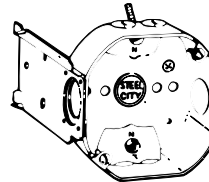

L Type
Used to mount octagon boxes. 2 5/8" long x 3 5/8" wide x 1/4" offset

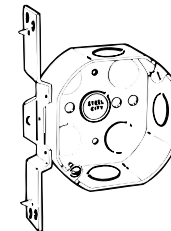

V Type
Mounts to flat side of stud. 7 3/8" long x 1" wide x 3/8" offset

Clamps

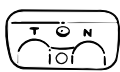

C-1



C-5

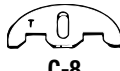

C-8

(Loom only)



C-10

C-3

For Armored Cable

For Non-Metallic Sheathed Cable and Non-Metallic Tubing (Loom)

UNDERWRITERS LABORATORIES INC. and CANADIAN STANDARDS ASSOCIATION file numbers for individual items available upon request.

Listing Information for Armored Cable Clamp — Type C-3

Armored Cable (BX) — Steel	Sizes 14-2 through 10-3	MCAP™ — Aluminum*	.370–.580
Armored Cable (BX) — Aluminum	Sizes 14-2 through 10-3	Flex Metal Conduit — Steel	1/8" Trade Size
MC Interlocked (MCI) — Steel	.449–.570 Diameter	Flex Metal Conduit — Aluminum	3/8" Trade Size
MC Interlocked (MCI) — Aluminum	.476–.606 Diameter	C-3 Clamp Acceptable for Grounding	
MC Corrugated (MCC) — Aluminum	.375–.515 Diameter	*MCAP™ is a trademark of Southwire Company	

"Products listed in this catalog are subject to alteration or discontinuation without prior notice."

Overview

NEC® Reference

Article 314 of the National Electrical Code® covers the installation and use of boxes. The article includes table references that guide the electrician in the selection of the proper box size necessary to safely accommodate electrical service requirements. The box capacity table shown (**page A-5**) is reproduced in part from the NEC® as a quick reference and guide. The NEC® should be consulted for complete details.

Article 314 — Boxes and Fittings

314.16 Number of Conductors in Outlet, Device, and Junction Boxes, and Conduit Bodies.

Boxes and conduit bodies shall be of sufficient size to provide free space for all enclosed conductors. In no case shall the volume of the box, as calculated in 314.16(A), be less than the fill calculation as calculated in 314.16(B). The minimum volume for conduit bodies shall be as calculated in 314.16(C).

The provisions of this section shall not apply to terminal housings supplied with motors or generators. Informational Note: For volume requirements of motor or generator terminal housings, see Article 430.12. Boxes and conduit bodies enclosing conductors #4 AWG or larger shall also comply with the provisions of 314.28.

(A) Box Volume Calculations.

The volume of a wiring enclosure (box) shall be the total volume of the assembled sections and, where used, the space provided by plaster rings, domed covers, extension rings and so forth, that are marked with their volume or are made from boxes the dimensions of which are listed in Table 314.16(A).

- (1) **Standard Boxes.** The volumes of standard boxes that are not marked with their volume shall be as given in Table 314.16(A).
- (2) **Other Boxes.** Boxes 1650 cm³ (100 in.³) or less, other than those described in Table 314.16(A), and nonmetallic boxes shall be durably and legibly marked by the manufacturer with their volume. Boxes described in Table 314.16(A) that have a volume larger than is designated in the table shall be permitted to have their volume marked as required by this section.

(B) Box Fill Calculations.

The volumes in paragraphs 314.16(B)(1) through (B)(5), as applicable, shall be added together. No allowance shall be required for small fittings such as locknuts and bushings.

- (1) **Conductor Fill.** Each conductor that originates outside the box and terminates or is spliced within the box shall be counted once, and each conductor that passes through the box without splice or termination shall be counted once. Each loop or coil of unbroken conductor not less than twice the minimum length required for free conductors in 300.14 shall be counted twice. The conductor fill shall be calculated using Table 314.16(B). A conductor, no part of which leaves the box, shall not be counted.

Exception: An equipment grounding conductor or conductors not over four fixture wires smaller than #14 AWG, or both, shall be permitted to be omitted from the calculations where they enter a box from a domed luminaire or similar canopy and terminate within that box.

- (2) **Clamp Fill.** Where one or more internal cable clamps, whether factory or field supplied, are present in the box, a single volume allowance in accordance with Table 314.16(B) shall be made based on the largest conductor present in the box. No allowance shall be required for a cable connector with its clamping mechanism outside the box.



- (3) **Support Fittings Fill.** Where one or more luminaire studs or hickey are present in the box, a single volume allowance in accordance with Table 314.16(B) shall be made for each type of fitting based on the largest conductor present in the box.
 - (4) **Device or Equipment Fill.** For each yoke or strap containing one or more devices or equipment, a double volume allowance in accordance with Table 314.16(B) shall be made for each yoke or strap based on the largest conductor connected to a device(s) or equipment supported by that yoke or strap. A device or utilization equipment wider than a single 50mm (2 in.) device box as described in Table 314.16(A) shall have double volume allowances provided for each gang required for mounting.
 - (5) **Equipment Grounding Conductor Fill.** Where one or more equipment grounding conductors or equipment bonding jumpers enter a box, a single volume allowance in accordance with Table 314.16(B) shall be made based on the largest equipment grounding conductor or equipment bonding jumper present in the box. Where an additional set of equipment grounding conductors, as permitted by 250.146(D), is present in the box, an additional volume allowance shall be made based on the largest equipment grounding conductor in the additional set.
- #### (C) Conduit Bodies.
- (1) **General.** Conduit bodies enclosing #6 AWG conductors or smaller, other than short-radius conduit bodies as described in 314.16(C)(2), shall have a cross-sectional area not less than twice the cross-sectional area of the largest conduit or tubing to which they can be attached. The maximum number of conductors permitted shall be the maximum number permitted by Table 1 of Chapter 9 for the conduit or tubing to which it is attached.
 - (2) **With Splices, Taps or Devices.** Only those conduit bodies that are durably and legibly marked by the manufacturer with their volume shall be permitted to contain splices, taps or devices. The maximum number of conductors shall be calculated in accordance with 314.16(B). Conduit bodies shall be supported in a rigid and secure manner.
 - (3) **Short-Radius Conduit Bodies.** Conduit bodies such as capped elbows and service-entrance elbows that enclose conductors #6 AWG or smaller, and are only intended to enable the installation of the raceway and the contained conductors, shall not contain splices, taps or devices and shall be of sufficient size to provide free space for all conductors enclosed in the conduit body.

Overview

Article 314 — Boxes and Fittings (continued)

Table 314.16(A)
Metal Boxes

MM	BOX TRADE SIZE (IN.)		MINIMUM VOLUME		MAXIMUM NUMBER OF CONDUCTORS*						
			CM ³	IN. ³	18	16	14	12	10	8	6
100 x 32	(4 x 1½)	Round/Octagonal	205	12.5	8	7	6	5	5	5	2
100 x 38	(4 x 1½)	Round/Octagonal	254	15.5	10	8	7	6	6	5	3
100 x 54	(4 x 2½)	Round/Octagonal	353	21.5	14	12	10	9	8	7	4
100 x 32	(4 x 1½)	Square	295	18.0	12	10	9	8	7	6	3
100 x 38	(4 x 1½)	Square	344	21.0	14	12	10	9	8	7	4
100 x 54	(4 x 2½)	Square	497	30.3	20	17	15	13	12	10	6
120 x 32	(4L x 1½)	Square	418	25.5	17	14	12	11	10	8	5
120 x 38	(4L x 1½)	Square	484	29.5	19	16	14	13	11	9	5
120 x 54	(4L x 2½)	Square	689	42.0	28	24	21	18	16	14	8
75 x 50 x 38	(3 x 2 x 1½)	Device	123	7.5	5	4	3	3	3	2	1
75 x 50 x 50	(3 x 2 x 2)	Device	164	10.0	6	5	5	4	4	3	2
75 x 50 x 57	(3 x 2 x 2¼)	Device	172	10.5	7	6	5	4	4	3	2
75 x 50 x 65	(3 x 2 x 2½)	Device	205	12.5	8	7	6	5	5	4	2
75 x 50 x 70	(3 x 2 x 2¾)	Device	230	14.0	9	8	7	6	5	4	2
75 x 50 x 90	(3 x 2 x 3½)	Device	295	18.0	12	10	9	8	7	6	3
100 x 54 x 38	(4 x 2½ x 1½)	Device	169	10.3	6	5	5	4	4	3	2
100 x 54 x 48	(4 x 2½ x 1¾)	Device	213	13.0	8	7	6	5	5	4	2
100 x 54 x 54	(4 x 2½ x 2¼)	Device	238	14.5	9	8	7	6	5	4	2
95 x 50 x 65	(3¾ x 2 x 2½)	Masonry Box/Gang	230	14.0	9	8	7	6	5	4	2
95 x 50 x 90	(3¾ x 2 x 3½)	Masonry Box/Gang	344	21.0	14	12	10	9	8	7	4
Min. 44.5 depth FS — Single-Cover/Gang (1¾)			221	13.5	9	7	6	6	5	4	2
Min. 60.3 depth FD — Single-Cover/Gang (2¾)			295	18.0	12	10	9	8	7	6	3
Min. 44.5 depth FS — Multiple-Cover/Gang (1¾)			295	18.0	12	10	9	8	7	6	3
Min. 60.3 depth FD — Multiple-Cover/Gang (2¾)			395	24.0	16	13	12	10	9	8	4

*Where no volume allowances are required by 314.16(B)(2) through 314.16(B)(5).
Underwriters Laboratories Inc. File Number: E2969 (U.L. 514A)
Canadian Standards Association File Number: LR 12798
Federal Manufacture Number: 56501 (Cage Code)
Products designed to meet Federal Specification Number: W-J-800
Verification of file numbers and compliance with federal specifications for individual items available upon request.
Box and cover material and plating specification; .062" minimum thickness, hot rolled, pre-galvanized steel, minimum spangle.
ASTM G-60-U, AISI C-1008
Bracket material: All brackets except MS style; 16 gauge (.060") hot rolled, pre-galvanized steel AISI C-1008, G-90-U. MS style bracket; 20 gauge (.036") cold rolled spring steel AISI C-1055, heat treated to R. 35 zinc plated .0005 thick.

Table 314.16(B)
Volume Allowance Required per Conductor

SIZE OF CONDUCTOR (AWG)	FREE SPACE WITHIN BOX FOR EACH CONDUCTOR	
	CM ³	IN. ³
No. 18	24.6	1.50
No. 16	28.7	1.75
No. 14	32.8	2.00
No. 12	36.9	2.25
No. 10	41.0	2.50
No. 8	49.2	3.00
No. 6	81.9	5.00

Reprinted with permission from National Fire Protection Association NFPA70-2011. National Electrical Code, Copyright© 2010, National Fire Protection Association, Quincy, MA 02269. This reprinted material is not the complete and official position of the NFPA on the referenced subject which is represented only by the standard in its entirety. NEC[®] is a registered trademark of the National Fire Protection Association, Inc., Quincy, MA 02269.

Underwriters Laboratories Inc. File Number: E2969 (U.L. 514A)
Canadian Standards Association File Number: LR 12798
Federal Manufacture Number: 56501
Products designed to meet Federal Specification Number: A-A5924 (formerly W-J-800).
Verification of file numbers and compliance with federal specifications for individual items available upon request.
Box and cover material and plating specification; .062" minimum thickness, hot-rolled, pre-galvanized steel, minimum spangle.
ASTM G-60-U, AISI C-1008
Bracket material: All brackets except MS style; 16 gauge (.060") hot rolled, pre-galvanized steel AISI C-1008, G-60-U. MS Style bracket; 20 gauge (.036") cold rolled spring steel AISI C-1055, heat treated to R. 35 zinc plated .0005 thick.

Metallic Boxes — Fire Resistance Rating

Wall Penetrations

Listed single- and double-gang metallic outlet and switch boxes and octagon ceiling boxes with metallic or non-metallic cover plates may be used in bearing and non-bearing wood stud and steel stud walls with ratings not exceeding 2 hours. These walls shall have gypsum wallboard facings similar to those shown in Design Nos. U301, U411, and U425. 4 in. square boxes may be used in 2 hr. fire rated ceilings.

The surface area of individual metallic outlet or switch boxes shall not exceed 16 sq. in. The aggregate surface area of the boxes shall not exceed 100 sq. inches per 100 sq. ft. of wall. Boxes located on opposite sides of walls or partitions shall be separated by a horizontal distance of 24 inches.

The metallic outlet or switch boxes shall be securely fastened to the studs and the opening in the wallboard facing shall be cut so that the clearance between the box and the wallboard does not exceed ¼ in.

Gang Boxes and Accessories

Multi-Gang Boxes

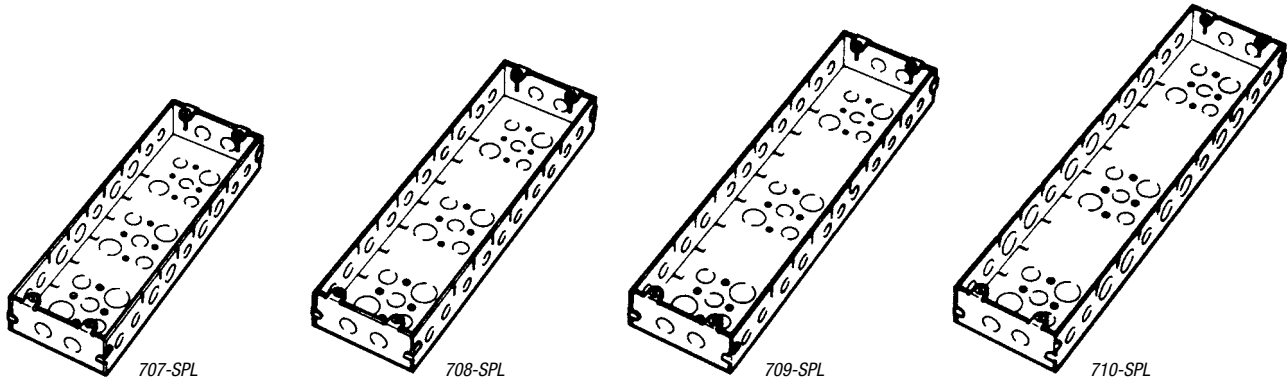

CAT. NO.	CU. IN. CAPACITY	DESCRIPTION	STD. CTN.
707-SPL	126.5	Seven-Gang Box, 1$\frac{1}{8}$" deep x 4$\frac{1}{8}$" long x 15$\frac{1}{16}$" wide Five $\frac{1}{2}$ " KOs and four $\frac{3}{4}$ " KOs in each side, two $\frac{1}{2}$ " KOs in each end and nine $\frac{1}{2}$ " KOs with six $\frac{3}{4}$ " KOs in bottom. Furnished with four 8/32 screws. For use with either Steel City® 807 and SB-7, 808 and SB-8, or just GB-7 rings and covers	1
708-SPL	141.3	Eight-Gang Box, 1$\frac{1}{8}$" deep x 4$\frac{1}{8}$" long x 17$\frac{3}{4}$" wide Six $\frac{1}{2}$ " KOs and four $\frac{3}{4}$ " KOs in each side, two $\frac{1}{2}$ " KOs in each end and nine $\frac{1}{2}$ " KOs with six $\frac{3}{4}$ " KOs in bottom. Furnished with four 8/32 screws. For use with either Steel City® 808 and SB-8, 809 and SB-9, or just GB-8 rings and covers	1
709-SPL	155.8	Nine-Gang Box, 1$\frac{1}{8}$" deep x 4$\frac{1}{8}$" long x 19$\frac{1}{8}$" wide Six $\frac{1}{2}$ " and five $\frac{3}{4}$ " KOs in each side and two $\frac{1}{2}$ " KOs in each end and nine $\frac{1}{2}$ " KOs with six $\frac{3}{4}$ " KOs in bottom. Furnished with four 8/32 screws. For use with either Steel City® 809 and SB-9, 810 and SB-10, or just GB-9 rings and covers	1
710-SPL	170.5	Ten-Gang Box, 1$\frac{1}{8}$" deep x 4$\frac{1}{8}$" long x 21$\frac{3}{8}$" wide Six $\frac{1}{2}$ " KOs and six $\frac{3}{4}$ " KOs in each side, two $\frac{1}{2}$ " KOs in each end and nine $\frac{1}{2}$ " KOs with six $\frac{3}{4}$ " KOs in bottom. Furnished with four 8/32 screws. For use with either Steel City® 810 and SB-10, or just GB-10 rings and covers	1

Gang Box Partitions

CAT. NO.	DESCRIPTION	STD. CTN.
SGP	Hi/low-voltage partition for 1 $\frac{1}{8}$ "-deep box	25
DGP	Hi/low-voltage partition for 2 $\frac{1}{2}$ "-deep box	50



SGP

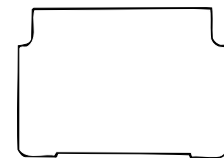

DGP

2-, 3- and 4-Gang Drawn-Style Device Boxes

CAT. NO.	GANG	DEPTH (IN.)	CU. IN. CAPACITY	EA. SIDE BRACKETS	EA. SIDE CONDUIT	EA. END CONDUIT	STD. CTN.
2G4DV 1/2 3/4	2	2 $\frac{1}{8}$	30.3	CV	2- $\frac{1}{2}$ " 1- $\frac{3}{4}$ "	2- $\frac{1}{2}$ " 1- $\frac{3}{4}$ "	25
3G4D 1/2	3	2 $\frac{1}{8}$	44.3	—	3- $\frac{1}{2}$ "	2- $\frac{1}{2}$ "	20
3G4D B 1/2	3	2 $\frac{1}{8}$	44.3	B	3- $\frac{1}{2}$ "	2- $\frac{1}{2}$ "	20
3G4D V 1/2	3	2 $\frac{1}{8}$	44.3	CV	3- $\frac{1}{2}$ "	2- $\frac{1}{2}$ "	20
4G4D 1/2	4	2 $\frac{1}{8}$	58.0	—	4- $\frac{1}{2}$ "	2- $\frac{1}{2}$ "	20
4G4D B 1/2	4	2 $\frac{1}{8}$	58.0	B	4- $\frac{1}{2}$ "	2- $\frac{1}{2}$ "	20
4G4D V 1/2	4	2 $\frac{1}{8}$	58.0	CV	4- $\frac{1}{2}$ "	2- $\frac{1}{2}$ "	20

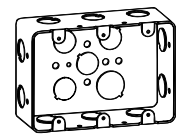

3G4D 1/2

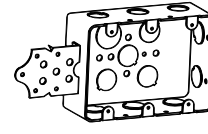

3G4D B 1/2



3G4D V 1/2

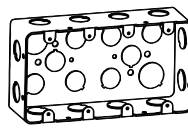

4G4D 1/2

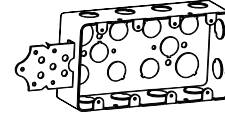

4G4D B 1/2

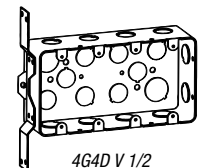

4G4D V 1/2

Gang Boxes and Accessories

Gang Box Covers

When covers are required to accommodate various combinations of devices, use the following catalog numbers plus the suffix "SPECIAL," and then indicate the combinations desired. When necessary, also indicate the sequence of devices.

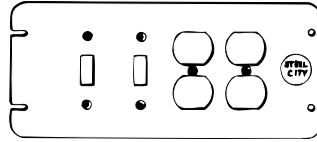

EXAMPLE: 4-GCS Special

- As illustrated (above), this is a 4-GCS Special for two toggle switches on left side and two duplex receptacles on right side

CAT. NO.	LGTH. (IN.)	CU. IN. CAPACITY	DESCRIPTION	STD. CTN.
4 1/16" Wide—Raised 1 3/16" for Plaster				
2-GC	7	8.5	Holes between gangs are spaced on	5
3-GC	8 1/16	13.5	1 3/16" centers; tapped holes in ears;	5
4-GC	10 5/16	18.3	spaced on 3 5/16" centers to accommodate	5
5 GC	12 1/16	23.0	all standard receptacles and switches;	5
6 GC	14 1/4	28.3	furnished with extra plugged screw holes; if these screw holes are used, the cover will fit the next smaller size box	5
4 1/16" Wide — Flat, Blank				
2-GCB	7	—	—	25
3-GCB	8 1/16	—	—	25
4-GCB	10 5/16	—	—	25
5 GCB	12 1/16	—	—	25
6 GCB	14 1/4	—	—	25
4 1/16" Wide — Flat for Toggle Switches				
2-GCS	7	—	For 2 toggle switches	25
3-GCS	8 1/16	—	For 3 toggle switches	25
4-GCS	10 5/16	—	For 4 toggle switches	25
5 GCS	12 1/16	—	For 5 toggle switches	25
6 GCS	14 1/4	—	For 6 toggle switches	25

4 1/16" wide — special covers — flat to accommodate combinations of devices.

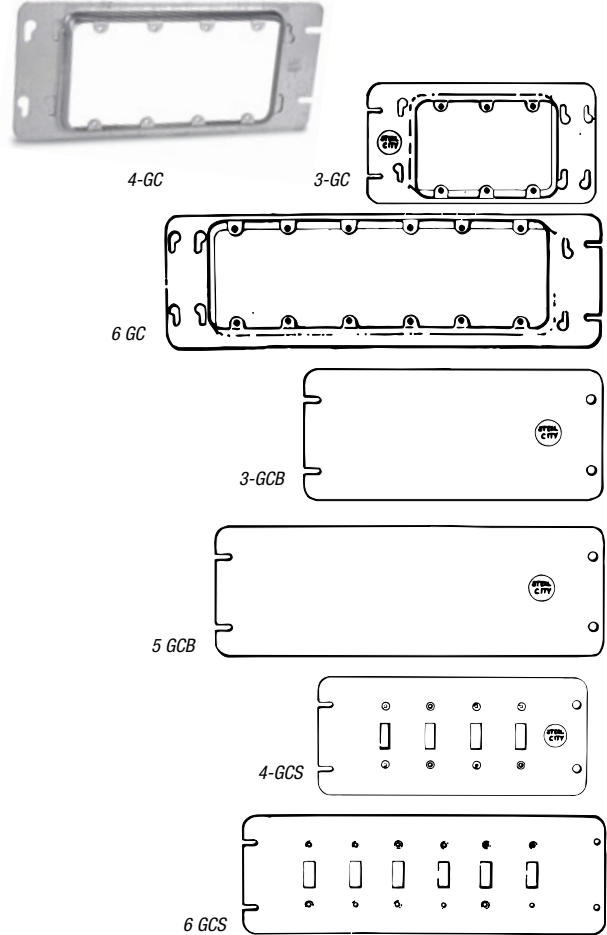

Multi-Gang Rings



CAT. NO.	CU. IN. CAPACITY	DESCRIPTION	STD. CTN.
807	36.3	A seven-gang switch ring, 3/4" raised x 4 9/16" long x 1 15/16" wide Fits Steel City® 706 or 707 outlet boxes and uses GB-7 covers	1
808	41.0	An eight-gang switch ring, 3/4" raised x 4 3/16" long x 1 7/4" wide Fits Steel City® 707 or 708 outlet boxes and uses GB-8 covers	1
809	46.5	A nine-gang switch ring, 3/4" raised x 4 1/16" long x 1 9/16" wide Fits Steel City® 708 or 709 outlet boxes and uses GB-9 covers	1
810	51.5	A ten-gang switch ring, 3/4" raised x 4 1/16" long x 2 1/16" wide Fits Steel City® 709 or 710 outlet boxes and uses GB-10 covers	1

Gang Boxes and Accessories

Multi-Gang Covers — SB Series

CAT. NO.	DESCRIPTION	STD. CTN.
SB-2	2-gang cover	1
SB-3	3-gang cover	1
SB-4	4-gang cover	1
SB-5	5-gang cover	1
SB-6	6-gang cover	1
SB-7	7-gang cover	1
SB-8	8-gang cover	1
SB-9	9-gang cover	1
SB-10	10-gang cover	1

Fits Steel City® 132, 133 and 134 series handy boxes (both welded and drawn) and 800 series multi-gang rings.

Multi-Gang Covers — GB Series

CAT. NO.	DESCRIPTION	STD. CTN.
GB-2	2-gang cover	1
GB-3	3-gang cover	1
GB-4	4-gang cover	1
GB-5	5-gang cover	1
GB-6	6-gang cover	1
GB-7	7-gang cover	1
GB-8	8-gang cover	1
GB-9	9-gang cover	1
GB-10	10-gang cover	1

Fits Steel City® 700 series multi-gang boxes.

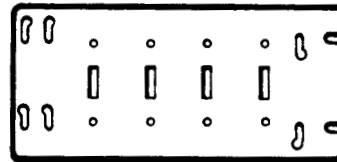
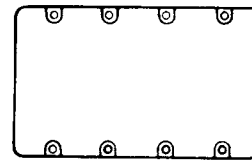
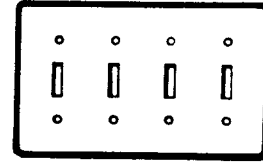

Typical Mounting Arrangement

How To Order.

1. Indicate style of cover "GB" or "SB"
2. Use symbols for each opening
3. Separate each symbol with a dash (-)
4. Allow 4 to 6 weeks for shipment

Symbols	Example:
DR Duplex Receptacle	
TS Toggle Switch	
SR Single Receptacle — Opening 1.4"	
B Blank	
TL Twist Lock (4-Wire) — Opening 1.594"	
	<p>↑ SB-5:DR ↑ TS ↑ SR ↑ B ↑ TL</p>



Gang Boxes
T&B Catalog Number:

5G 1/2 3/4

UPC Number:

78599113105

Status:

Active

Description:

Five gang pre-galvanized steel gang box, 12-1/4 inch x 4-1/2 inch x 1-5/8 inch, 85 cuin. Drawn construction with 1/2 inch & 3/4 inch knockouts. For use with conduit.

General

Material	Steel
Finish	Galvanized
Volume (cu.in.)	85
Construction	Drawn
Number of Gangs	Five
Knockouts-Each Side (Conduit)	(4) - 1/2", (3) - 3/4"
Knockouts-Each End (Conduit)	(1) - 1/2", (1) - 3/4"
Knockouts-Bottom (Conduit)	(6) - 1/2", (4) - 3/4"
Knockouts_IDW	Yes

Dimension Information

Length (inches)	12 1/4
Width (inches)	4 1/2
Depth (inches)	1 5/8

Packaging

Package in Units	1
T&B Sold in UOM	Each
T&B Weight Per UOM	180 lbs. per 100

Application Support

T&B Sales Drawings	wsd-001290
Product Overview	Available on Website
NEC Article 314 - Boxes and Fittings	Available on Website
Product Overview-Gang Boxes & Accessories	Available on Website

Certifications

RoHS Compliance	No
-----------------	----

Certifications



File Nbr:
E 2969

For further technical assistance, please contact us...

Thomas & Betts - USA
8155 T&B Blvd.
Memphis, TN 38125
www.tnb.com

T&B Technical Support
MS 3B-50
8155 T&B Blvd.
Memphis, TN 38125

Hours: 7AM - 6PM CDT
Monday-Friday
Phone: (888) 862-3289
Fax: (901) 252-1321
Email:techsupport@tnb.com